

# electronics

A MCGRAW-HILL PUBLICATION

MARCH • 1951

ANTENNA TEST TOWER







# ULTRA COMPACT UNITS...OUNCER UNITS

## HIGH FIDELITY . . . SMALL SIZE . . . FROM STOCK

UTC Ultra compact audio units are small and light in weight, ideally suited to remote amplifier and similar compact equipment. High fidelity is obtainable in all individual units, the frequency response being  $\pm 2$  DB from 30 to 20,000 cycles.

True hum balancing coil structure combined with a high conductivity die cast outer case, effects good inductive shielding.



TYPE A CASE  
1 1/2" x 1 1/2" x 2" high

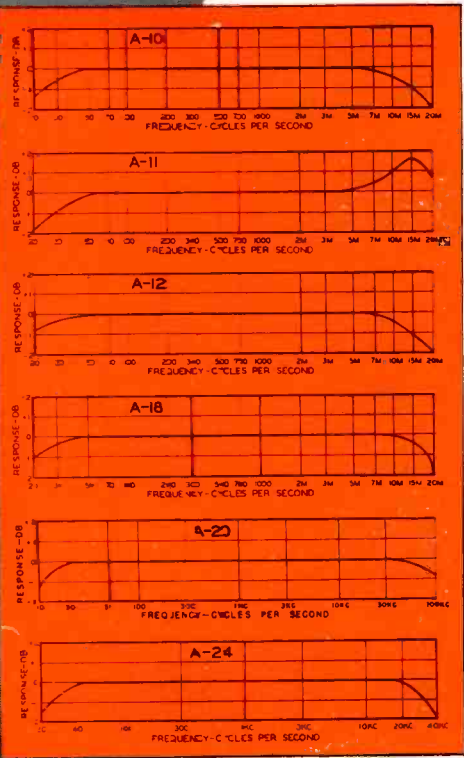

Type No.	Application	Primary Impedance	Secondary Impedance	List Price
A-10	Low impedance mike, pickup, or multiple line to grid	50, 125/150, 200/250, 333, 500/600 ohms	50 ohms	\$15.00
A-11	Low impedance mike, pickup, or line to 1 or 2 grids (multiple alloy shields for low hum pickup)	50, 200, 500	50,000 ohms	16.00
A-12	Low impedance mike, pickup, or multiple line to grids	50, 125/150, 200/250, 333, 500/600 ohms	80,000 ohms overall, in two sections	15.00
A-14	Dynamic microphone to one or two grids	30 ohms	50,000 ohms overall, in two sections	14.00
A-20	Mixing, mike, pickup, or multiple line to line	50, 125/150, 200/250, 333, 500/600 ohms	50, 125/150, 200/250, 333, 500/600 ohms	15.00
A-21	Mixing, low impedance mike, pickup, or line to line (multiple alloy shields for low hum pickup)	50, 200/250, 500/600	50, 200/250, 500/600	16.00
A-16	Single plate to single grid	15,000 ohms	60,000 ohms, 2:1 ratio	13.00
A-17	Single plate to single grid 8 MA unbalanced D.C.	As above	As above	15.00
A-18	Single plate to two grids. Split primary	15,000 ohms	80,000 ohms overall, 2.3:1 turn ratio	14.00
A-19	Single plate to two grids 8 MA unbalanced D.C.	15,000 ohms	80,000 ohms overall, 2.3:1 turn ratio	18.00
A-24	Single plate to multiple line	15,000 ohms	50, 125/150, 200/250, 333, 500/600 ohms	15.00
A-25	Single plate to multiple line 8 MA unbalanced D.C.	15,000 ohms	50, 125/150, 200/250, 333, 500/600 ohms	14.00
A-26	Push pull low level plates to multiple line	30,000 ohms plate to plate	50, 125/150, 200/250, 333, 500/600 ohms	15.00
A-27	Crystal microphone to multiple line	100,000 ohms	50, 125/150, 200/250, 333, 500/600 ohms	15.00
A-30	Audio choke, 250 henrys @ 5 MA 6000 ohms D.C. .65 henrys @ 10 MA 1500 ohms D.C.			10.00
A-32	Filter choke 60 henrys @ 15 MA 2000 ohms D.C. .15 henrys @ 30 MA 500 ohms D.C.			9.00

UTC OUNCER components represent the acme in compact quality transformers. These units, which weigh one ounce, are fully impregnated and sealed in a drawn aluminum housing 7/8" diameter... mounting opposite terminal board. High fidelity characteristics are provided, uniform from 40 to 15,000 cycles, except for O-14, O-15, and units carrying DC which are intended for voice frequencies from 150 to 4,000 cycles. Maximum level 0 DB.



OUNCER CASE  
7/8" Dia. x 1 1/8" high

Type No.	Application	Pri. Imp.	Sec. Imp.	List Price
O-1	Mike, pickup or line to 1 grid	50, 200/250 500/600	50,000	\$13.25
O-2	Mike, pickup or line to 2 grids	50, 200/250 500/600	50,000	13.25
O-3	Dynamic mike to 1 grid	7.5/30	50,000	12.00
O-4	Single plate to 1 grid	15,000	60,000	10.50
O-5	Plate to grid, D.C. in Pri.	15,000	60,000	10.50
O-6	Single plate to 2 grids	15,000	95,000	12.00
O-7	Plate to 2 grids, D.C. in Pri.	15,000	95,000	12.00
O-8	Single plate to line	15,000	50, 200/250, 500/600	13.25
O-9	Plate to line, D.C. in Pri.	15,000	50, 200/250, 500/600	13.25
O-10	Push pull plates to line	30,000 ohms plate to plate	50, 200/250, 500/600	13.25
O-11	Crystal mike to line	50,000	50, 200/250, 500/600	13.25
O-12	Mixing and matching	50, 200/250	50, 200/250, 500/600	12.00
O-13	Reactor, 300 Hys.—no D.C.; 50 Hys.—3 MA. D.C.,		6000 ohms	9.50
O-14	50:1 mike or line to grid	200	1/2 megohm	13.25
O-15	10:1 single plate to grid	15,000	1 megohm	13.25

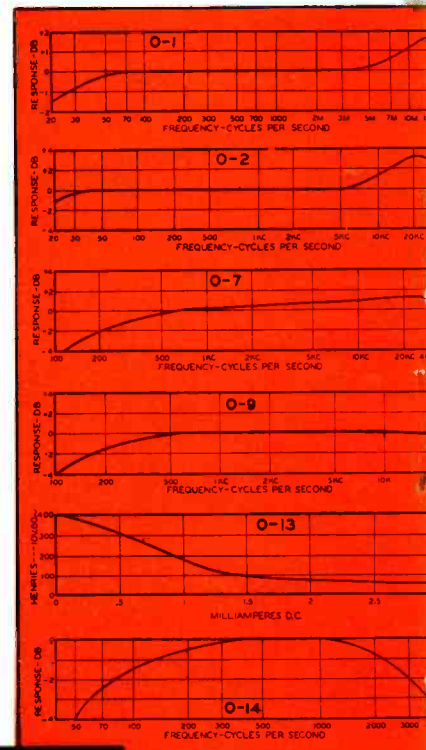

*United Transformer Co.*  
150 VARICK STREET • NEW YORK 13, N. Y.

EXPORT DIVISION: 13 EAST 40th STREET, NEW YORK 16, N. Y., CABLES: "ARLAB"



# electronics



A MCGRAW-HILL  
PUBLICATION

MARCH • 1951

<b>ANTENNA TEST TOWER</b> .....	<b>COVER</b>
Critical measurements are made at the Andrew Corporation's Orland Park, Illinois, research lab with the aid of this structure. A bulldozer skids it about the grounds and the height of arrays is readily varied by means of a sliding frame (see p 138)	
<b>LATEST DEVELOPMENTS IN ULTRASONICS</b> , by Arthur R. Laufer.....	<b>82</b>
Latest laboratory experiments show promise for future application in research, industry and communications	
<b>NEW MILITARY AIDS</b> .....	<b>87</b>
Equipments to be exhibited by the armed forces at the 1951 IRE National Convention	
<b>DETECTING TRAMP METAL IN LOGS AND IRON ORE</b> , by C. W. Clapp.....	<b>88</b>
Mathematical analysis of problem, and examples of successful applications involving sea water and iron ore	
<b>P-M FOCUS MAGNETS FOR PICTURE TUBES</b> , by R. T. Capodanno.....	<b>94</b>
Results of extensive study of all types, with advantages, drawbacks and design considerations	
<b>A MODERN FREQUENCY-MEASURING INSTALLATION</b> , by H. A. Taylor and E. C. Rundquist.....	<b>98</b>
A commercial measurement service described in terms of the Riverhead monitor	
<b>MICROWAVE RADAR ANTENNA</b> , by H. N. Chait.....	<b>103</b>
Permits study of polarization of returned radar signals	
<b>THYRATRON GRID CIRCUIT DESIGN</b> , by James H. Burnett.....	<b>106</b>
Seven basic methods of controlling firing angle, four primary sources of noise and other criteria for reliable operation	
<b>SEMICONDUCTOR DIODES</b> .....	<b>112</b>
Summary of characteristics of silicon and germanium crystal diodes, with dimensions and terminal data	
<b>F-M and TV STATION COSTS</b> , by R. C. Singleton.....	<b>114</b>
Investment in dollars per mile of coverage is readily estimated by the method outlined	
<b>PLANNING COIL PRODUCTION</b> , by Carl E. Sullivan, Jr.....	<b>117</b>
Instructions for constructing nomograph that gives minimum coil lot size at which automatic winder becomes economical	
<b>LOCKED-IN OSCILLATOR FOR TV SOUND</b> , by M. S. Corrington.....	<b>120</b>
Provides greater rejection of unwanted signals than tuned circuits alone	
<b>DIRECT-COUPLED AMPLIFIER STARVATION CIRCUITS</b> , by W. K. Volkers.....	<b>126</b>
Extremely low screen voltage and high plate load resistance give high gain, reduce components in d-c amplifier	
<b>FLAT REFLECTOR FOR UHF SYSTEMS</b> , by Thomas Royston.....	<b>130</b>
Technical and economic aspects of using flat reflectors are discussed	
<b>SERVO POWER CALCULATIONS</b> , (Reference Sheet), by Oscar E. Carlson.....	<b>134</b>
Chart gives required motor shaft output in watts for any required combination of speed and torque	
<b>BUSINESS BRIEFS</b> .....	<b>76</b>
<b>CROSSTALK</b> .....	<b>81</b>
<b>TUBES AT WORK</b> .....	<b>136</b>
<b>ELECTRON ART</b> .....	<b>140</b>
<b>NEW PRODUCTS</b> .....	<b>144</b>
<b>NEWS OF THE INDUSTRY</b> .....	<b>148</b>
<b>NEW BOOKS</b> .....	<b>152</b>
<b>BACKTALK</b> .....	<b>154</b>
<b>INDEX TO ADVERTISERS</b> .....	(Last Page)

**DONALD G. FINK**, Editor; **W. W. MacDONALD**, Managing Editor; **John Markus**, Vin Zeluff, A. A. McKenzie, Associate Editors; **William P. O'Brien**, James D. Fahnestock, Assistant Editors; **John M. Carroll** (on Military Leave), Ronald Jurgen, Ann Mastropolo, Marilyn B. Smith, Editorial Assistants; **Gladys T. Montgomery**, Washington Editor; **Harry Phillips**, Art Director; **Eleanor Luke**, Art Assistant

**KEITH HENNEY**, Consulting Editor

**H. W. MATEER**, Publisher; **WALLACE B. BLOOD**, Manager; **R. S. Quint**, Buyers' Guide Manager; **D. H. Miller**, James Girdwood, New York; **Wm. S. Hodgkinson**, New England; **Warren W. Shew**, Philadelphia; **C. D. Wardner**, Chicago; **J. L. Phillips**, Cleveland; **J. W. Otterson**, San Francisco; **Carl W. Dysinger**, Los Angeles; **Ralph C. Maultsby**, Atlanta; **Bernard H. Butler**, London, England



March, 1951

ELECTRONICS

Member ABC and AEP

Vol. 24, No. 3



Published monthly with an additional issue in June by McGraw-Hill Publishing Company, Inc., James H. McGraw (1860-1948), Founder. Publication Office, 99-129 North Broadway, Albany 1, N. Y.

Executive, Editorial and Advertising Offices: McGraw-Hill Building, 330 W. 42nd St., New York 18, N. Y. Curtis W. McGraw, President; Willard Chevalier, Executive Vice-President; Joseph A. Gerardi, Vice-President and Treasurer; John J. Cooke, Secretary; Paul Montgomery, Senior Vice-President, Publications Division; Ralph B. Smith, Editorial Director; Nelson Bond, Vice-President and Director of Advertising; J. E. Blackburn, Jr., Vice-President and Director of Circulation.

Subscriptions: Address correspondence to Electronics—Subscription service, 99-129 N. Broadway, Albany 1, N. Y., or 330 W. 42nd St., New York 18, N. Y. Allow ten days for change of address. Please indicate position and company connection on all subscription orders.

Single copies 75¢ for United States and possessions, and Canada; \$1.50 for Latin America; \$2.00 for all other foreign countries. Buyers' Guide \$2.00. Subscription rates—United States and possessions, \$6.00 a year; \$9.00 for two years; \$12.00 for three years. Canada, \$10.00 a year; \$16.00 for two years; \$20.00 for three years. Pan American countries, \$15.00 a year; \$25.00 for two years; \$30.00 for three years. All other countries \$20.00 a year; \$30.00 for two years; \$40.00 for three years. Entered as second class matter August 29, 1936, at the Post Office at Albany, N. Y., under act of Mar. 3, 1879. Printed in U. S. A. Copyright 1951 by McGraw-Hill Publishing Co., Inc.—All Rights Reserved. BRANCH OFFICES: 520 North Michigan Avenue, Chicago 11, Ill.; 68 Post Street, San Francisco 4; Aldwych House, Aldwych, London, W.C. 2; Washington, D. C. 4; Philadelphia 3; Cleveland 15; Detroit 26; St. Louis 8; Boston 16; Atlanta 3, Ga.; 1111 Wilshire Blvd., Los Angeles 17; 738-9 Oliver Building, Pittsburgh 22. ELECTRONICS is indexed regularly in The Engineering Index.





setting **new** standards  
for  
electrical instruments



## MARION RUGGEDIZED METERS

This amazing new family of Marion ruggedized electrical indicating instruments sets new standards of quality and accuracy in electrical measurement. Marion "Ruggedized" instruments give better performance in *any* application. Use them with confidence even where you never before dared use "delicate instruments." They exceed all JAN-I-6 requirements, are *hermetically sealed* and completely interchangeable with existing JAN 2½" and 3½" types.

Marion Ruggedized instruments perform perfectly under critical conditions of shock, vibration, mechanical stress and strain. Hermetic sealing makes them impervious to weather and climate.

When you want the *best* in meters for any application — from bulldozers to Geiger Counters — insist on Marion, the name that means the most in meters.

Send for our booklet on Marion Ruggedized Instruments. Marion Electrical Instrument Company, 401 Canal Street, Manchester, New Hampshire.



Manufacturers of  
Hermetically Sealed  
Meters Since 1944

MARION MEANS THE MOST IN METERS

Canadian Representative: Astral Electric Company, 44 Danforth Road, Toronto, Ontario, Canada  
Export Division: 458 Broadway, New York 13, U.S.A., Cables MORHANEX



# marion meters



**PUT YOUR NAME ON OUR MAILING LIST**

*for*

# TECHNIQUE

A JOURNAL OF INSTRUMENT ENGINEERING

MUIRHEAD  
APPARATUS  
COVERS A WIDE  
RANGE OF REQUIRE-  
MENTS FOR ELECTRICAL  
MEASUREMENTS AND  
TESTING, SERVO AND  
REMOTE CONTROL PURPOSES,  
AND FOR PHOTOTELEGRAPHY.

**AVAILABLE FREE OF CHARGE**

**TO RESEARCH WORKERS**

**TO TECHNICIANS**

**TO SCIENTISTS**

**TO ENGINEERS**

*and others who are interested in scientific and  
electronic instruments and their applications*

**POST  
COUPON  
TODAY**

MUIRHEAD & CO., LTD.  
BECKENHAM · KENT · ENGLAND

NAME \_\_\_\_\_

MAILING ADDRESS \_\_\_\_\_

COMPANY \_\_\_\_\_

POSITION \_\_\_\_\_

**MUIRHEAD & Co LTD**  
PRECISION ELECTRICAL INSTRUMENT MAKERS  
BECKENHAM · KENT · ENGLAND

PRECISION  
**MUIRHEAD**  
ELECTRICAL INSTRUMENTS

Telegrams & Cables MUIRHEAD ELMERS-END



# A complete line

for  
RESISTORS  
too!

Unusual combinations of characteristics required in today's critical electronic circuits demand a complete range of resistor types. Specializing in resistors, IRC makes the widest line in the industry. This means ease of procurement—a single dependable source of supply for *all* your resistance needs. It also means unbiased recommendations—no substitution of units "just as good". IRC's complete line of products; complete research and testing facilities; complete network of licensees for emergency production—all add up to complete satisfaction for you.



## PRECISION RESISTORS

### CONTROLS



IRC Type W Wire Wound Controls are designed for long, dependable service and balanced performance in every characteristic. These 2-watt variable wire wound units provide maximum adaptability to most rheostat and potentiometer applications within their power rating. Catalog Bulletin A-2.

IRC New Type Q Controls feature small  $\frac{1}{8}$ " size, rugged construction and superior performance. Increased arc of rotation permits same resistance ratios successful in larger IRC Controls. Catalog Bulletin A-4.

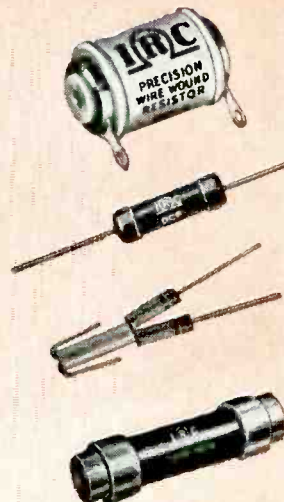

IRC Precision Wire Wounds offer a fine balance of accuracy and dependability for close-tolerance applications. Extensively used by leading instrument makers, they excel in every significant characteristic. Catalog Bulletin D-1.

IRC Deposited Carbon PRECISTORS combine accuracy and economy for close-tolerance applications, where carbon compositions are unsuitable and wire-wound precisions too expensive. Catalog Bulletin B-4.

IRC Matched Pairs provide a dependable low-cost solution to close-tolerance requirements. Both Type BT and BW Resistors are available in matched pairs. Catalog Bulletin B-3.

IRC Sealed Precision Voltmeter Multipliers are suitable and dependable for use under the most severe humidity conditions. Each consists of several IRC Precisions mounted and interconnected, enclosed in a glazed ceramic tube. Catalog Bulletin D-2.



# is essential

## HIGH FREQUENCY and HIGH POWER RESISTORS



IRC Type MP High Frequency Resistors afford stability with low inherent inductance and capacity in circuits involving steep wave fronts, high frequency measuring circuits and radar pulse equipment. Available in sizes from 1/4 to 90 watts. Catalog Bulletin F-1.



Type MV High Voltage Resistors utilize IRC's famous filament resistance coating in helical turns on a ceramic tube to provide a conducting path of long, effective length. Result: Exceptional stability even in very high resistance values. Catalog Bulletin G-1.

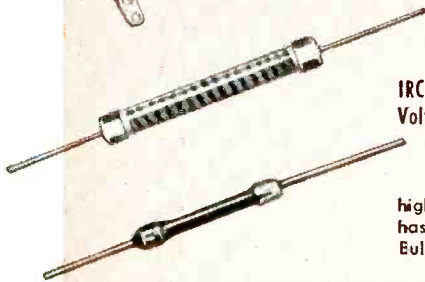

IRC Type MVX High Ohmic, High Voltage Resistors meet requirements for a small high range unit with axial leads. Engineered for high voltage applications, MVX has exceptional stability. Catalog Bulletin G-2.

IRC Type MPM High Frequency Resistors are miniature units suitable for high frequency receiver and similar applications. Stable resistors with low inherent inductance and capacity. Body only 3/8" long. Catalog Bulletin F-1.

Wherever the Circuit Says

- Power Resistors • Voltmeter Multipliers
- Insulated Composition Resistors • Low Wattage Wire Wounds • Volume Controls • Voltage Dividers • Precision Wire Wounds • Deposited Carbon Precistors • Ultra-HF and High Voltage Resistors • Insulated Chokes



**INTERNATIONAL RESISTANCE COMPANY**  
 PHILADELPHIA 8, PENNSYLVANIA  
 (In Canada: International Resistance Company, Ltd., Toronto, Licensee)

## INSULATED COMPOSITION and WIRE WOUND RESISTORS



IRC Advanced Type BT Resistors meet and beat JAN-R-11 Specifications at 1/3, 1/2, 1 and 2 watts—combine extremely low operating temperature with excellent power dissipation. Catalog Bulletin B-1.

IRC Type BW Wire Wound Resistors are exceptionally stable, inexpensive units for low range requirements. Have excellent performance records in TV circuits, meters, analyzers, etc. Catalog Bulletin B-5.

IRC Type BTAV High Voltage Resistors, developed for use as discharge resistors in fluorescent "Quick Start" ballasts, withstand momentary peak surge of 6000 volts. Also suited to TV bleeder circuits. Catalog Bulletin B-1.

## POWER RESISTORS

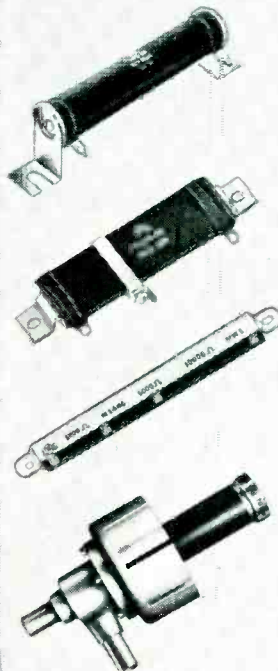

IRC Fixed and Adjustable Power Wire Wounds give balanced performance in every characteristic—are available in a full range of sizes, types and terminals for exacting, heavy-duty applications. Catalog Bulletin C-2.

IRC Type FRW Flat Wire Wound Resistors fulfill requirements of high wattage dissipation in limited space—may be mounted vertically or horizontally, singly or in stacks. Catalog Bulletin C-1.

IRC Type MW Wire Wound Resistors offer low initial cost, lower mounting cost, flexibility in providing taps, and saving in space. Completely insulated against moisture. Catalog Bulletin B-2.

IRC Type LP Water-Cooled Resistors for TV, FM and Dielectric Heating Applications. Cooled internally by high velocity stream of water; adjustable to local water pressure and power dissipation up to 5 K.W.A.C. Catalog Bulletin F-2.

INTERNATIONAL RESISTANCE CO.  
 403 N. BROAD ST., PHILADELPHIA 8, PA.

Please send me Technical Data Bulletins checked below:

- |  |   |   |
|--|---|---|
| <input type="checkbox"/> Bulletin A-2 (W)    | <input type="checkbox"/> Bulletin B-4 (DC)  | <input type="checkbox"/> Bulletin F-1 (MP)  |
| <input type="checkbox"/> Bulletin A-4 (Q)    | <input type="checkbox"/> Bulletin B-5 (BW)  | <input type="checkbox"/> Bulletin F-1 (MPM) |
| <input type="checkbox"/> Bulletin B-1 (BT)   | <input type="checkbox"/> Bulletin C-1 (FRW) | <input type="checkbox"/> Bulletin F-2 (LP)  |
| <input type="checkbox"/> Bulletin B-1 (BTAV) | <input type="checkbox"/> Bulletin C-2 (PWW) | <input type="checkbox"/> Bulletin G-1 (MV)  |
| <input type="checkbox"/> Bulletin B-2 (MW)   | <input type="checkbox"/> Bulletin D-1 (WW)  | <input type="checkbox"/> Bulletin G-2 (MVX) |
| <input type="checkbox"/> Bulletin B-3 (M/P)  | <input type="checkbox"/> Bulletin D-2 (MF)  |   |

NAME.....

TITLE.....

COMPANY.....

ADDRESS.....

CITY..... ZONE..... STATE.....

J. F. ARNDT & CO., ADV. AGENCY



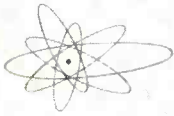

# Designers



## MAKE 16 GROUND CONNECTIONS IN 1 MINUTE!

Low-resistance joints that hold at over 125°C easily made with **G-E PRECISION CONTROL FOR RESISTANCE WELDERS**

Operators are making sixteen ground connections a minute to a television-receiver chassis with G. E.'s precision-control resistance welding method.

The compact electronic spot-welding control shown here has been specifically designed for use in conjunction with small bench welders or tongs and thus is ideally suited for many of the otherwise expensive assembly operations encountered in the manufacture of electronic equipment.

The panel provides for welding-current to control the amount of heat produced in the welds. Once set, successive welding currents remain constant to assure accurate and consistent welding of connections.

Complete data in Bulletin GEA-4175.

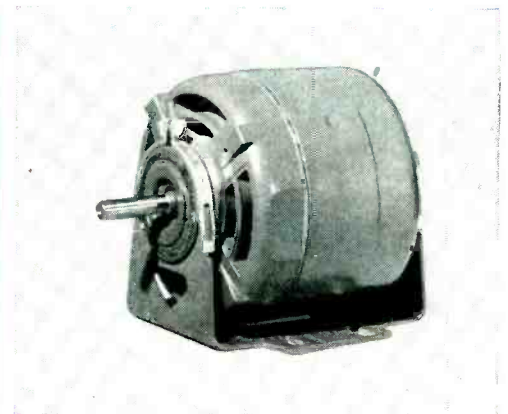

## NEW! Unit-Bearing Motor for fans and blowers

- all angle operation
- improved appearance
- provision for 4-way mounting
- quiet operation
- requires no additional lubrication
- adjustable-speed operation available

Available in ratings from 25 millihorsepower to 1/12 horsepower to match many fan or blower sizes, this new G-E unit-bearing motor uses a new lubrication system and bearing design that permit reliable operation in any position. For extremely quiet operation, resilient cradle-base or end-ring mounting may be supplied. Suitable control is available for two-speed or adjustable-speed operation. More data in Bulletins GEA-5338 and GEC-219A.



667-11

# Digest

## TIMELY HIGHLIGHTS ON G-E COMPONENTS

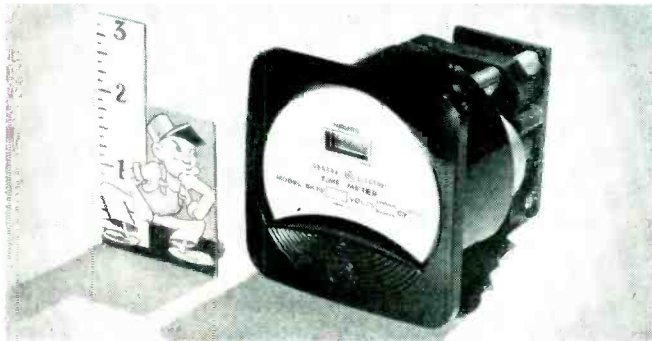

### replace tubes **BEFORE** THEY FAIL! —record life with G-E time meters

A vacuum tube can usually be replaced *before* it fails if you have an accurate indication of operating time on the electronic device on which the tube is used.

G-E time meters, with dependable Telechron® motor drive, record operating time in hours, tenths of hours, or minutes, and are supplied for 115-, 230-, or 460-volts. The molded Textolite† case harmonizes with other G-E 3½-inch instruments mounted on the same panel. For more information, including dimensions, write for Bulletin GEC-472.

\*Reg. T. M. Telechron, Inc.

†Reg. T. M. General Electric Co.

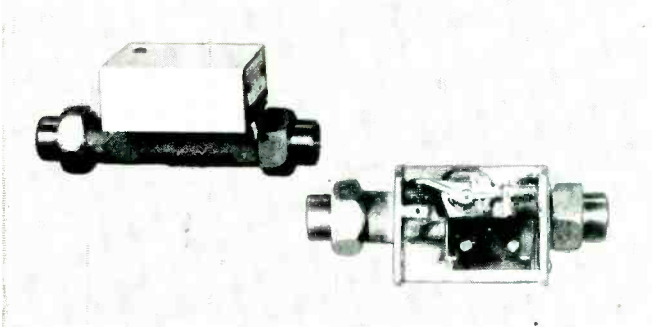

### sure protection against overheating!

This G-E flow interlock opens the electric circuit of your water-cooled components when water flow is lower than a preset minimum, closes it when flow is above this point.

Depending on adjustment, the interlock will actuate the electric contact for any flow between ½ and four gallons per minute. Cut-in, cut-out differential is 0.1 gpm.

Ratings: 10 amps, 120 or 240 volts a-c; maximum water-line pressure is 125 lb./sq. in. Unit is bronze with standard ½-inch fittings, is easy to install and adjust. See Bulletin GEC-411.



### select **10** ranges **INSTANTLY** with this **HIGH SENSITIVITY VTVM**

**CALIBRATED RANGES:** .001 to 300 volts (10 cycles to 1.5 mc.); -52 to +52 db (ref. level -1 mw at 600 v.)

Just about everything you could ask for in a high-sensitivity vacuum tube voltmeter! Frequency range of this G-E Type AA-1 instrument is substantially flat from 10 cycles to one megacycle with voltage ranges of 0-.01, 0-.03, 0-0.1, 0-0.3, 0-1.0, 0-3.0, 0-10, 0-30, 0-100, 0-300, decibels from -52 to +52 in 10 ranges.

Ten-position pushbutton switch instantly selects range without passing through intermediate stages. This vacuum-tube voltmeter is stable, has high impedance input, uses full-wave rectification, and has an amplifier output of 3 volts. More in Bulletin GEC-461.

General Electric Company, Section A 667-11  
Apparatus Department, Schenectady 5, N. Y.

Please send me the following bulletins:

- |                                     |  |
|-------------------------------------|--|
| Indicate                            | <input type="checkbox"/> GEA-4175 Welding control      |
| ✓ for reference only                | <input type="checkbox"/> GEA-5338 Fan motors           |
| X for planning an immediate project | <input type="checkbox"/> GEC-219A Fan motors           |
|                                     | <input type="checkbox"/> GEC-411 Flow interlock        |
|                                     | <input type="checkbox"/> GEC-461 Vacuum-tube voltmeter |
|                                     | <input type="checkbox"/> GEC-472 Time meters           |

Name \_\_\_\_\_

Company \_\_\_\_\_

Address \_\_\_\_\_

City \_\_\_\_\_ State \_\_\_\_\_



# THE NEW TURNER



**MODEL 50D DYNAMIC  
FOR TV - AM - FM  
Recording • Broadcast  
Public Address**

The crown jewel of dynamic microphones. See it, handle it — use it on highest quality recording, public address or broadcast work. New beauty, new styling, new utility and *new performance* make the Turner *Aristocrat* the finest of the fine. Use it anywhere, indoors or out — in hand, on stand, suspended, or concealed in stage settings. The *Aristocrat* is quickly and easily detached from ball swivel coupler for hand use. Non-directional polar pattern picks up sound from any direction. Equally effective for individual or group pickups with wide range, high fidelity reproduction of voice or music. Its high output dynamic generator requires no closely associated auxiliary equipment for outstanding results. Built of finest materials with flawless workmanship, each unit is laboratory calibrated to insure specification standards. . . . Write for complete details.

#### SPECIFICATIONS:

FREQUENCY RESPONSE: 50 to 15,000 c.p.s. flat within  $\pm 2\frac{1}{2}$ db.  
OUTPUT LEVEL: 56 db below 1 volt/dyne/sq. cm.  
IMPEDANCE: 15, 200, 500 ohms or high impedance.  
POLAR PATTERN: Essentially non-directional in any position.  
MOUNTING: Ball and swivel type, tilts in any direction. Standard  $\frac{5}{8}$ " — 27 thread.  
CABLE: 20 ft., high quality rubber covered, two conductor shielded cable with Cannon quick-disconnect plug.

#### THE TURNER COMPANY

905 17th Street N. E., • Cedar Rapids, Iowa  
IN CANADA: Canadian Marconi Co., Montreal, P. Q., and Branches  
EXPORT: Ad. Auriema, Inc., 89 Broad Street, New York 4, N. Y.



*Microphones* **BY TURNER**

closed  
Industrials  
IMES index re  
se of 271.01, t  
0.6, up 0.27, and  
rages at 165.83 w  
were irreg  
s in the

# U.S. Tin Curb Limits Supply Held by Plants

WASHINGTON, Dec. 19.—The National Production Authority is ordering a 20 per cent cut in civilian use of tin during February and March, also limited tin manufacturers' inventories of tin to a 120-day supply and other pig tin users to a 60-day inventory.

To encourage substitution of plentiful metals, the authority bids use of new tin when primary tin can be reused and more lead can be produced in lead alloys for solder, and possible tubes used for steam, dental paste and other products.

The long-range effect of the order will be to cut the supply of tin for food, beer and other consumer products. But the shortage will not be felt by consumers until late next year, when the use of tin in solder and other products already in production is expected to be cut. EPA officials said tin con-

# 1951 TIN SOLDIER...

and the question of SPEED on your assembly line

Important Now! You will be interested to know that many

ERSIN MULTICORE users report higher speed and greater

dependability using MULTICORE of lower tin content

than other solders... due to extra-active, non-corrosive

ERSIN FLUX and Thin-Wall Triple-Core construction.

Specify ERSIN MULTICORE to insure rapid melting, continuity of flux and perfect bonding—even on difficult metals. Maintain speed on your assembly line, yet prevent "dry" joints. ERSIN MULTICORE is the World's Finest Solder—costs less because it saves time and avoids rejects.

**ERSIN**

# Multicore

THE ORIGINAL 3 CORE SOLDER... THE ONLY SOLDER MADE WITH NON-CORROSIVE, EXTRA-ACTIVE ERSIN FLUX.



New Edition! FREE—Valuable booklet "Modern Solders" and testing samples available on request.

Address U. S. A. and Canadian inquiries to

**MULTICORE SALES CORP.**  
164 Duane Street • New York 13, N. Y.

Inquiries regarding other territories to

**MULTICORE SOLDERS LTD.**  
Mellier House, Albemarle Street • London, W. 1, England



# Looking for trouble before it starts...

with an **MB VIBRATION EXCITER**



One of the many instruments produced by the Sperry Gyroscope Company is here undergoing a "shake test" on the MB model S-3 Vibration Exciter. Such vibration testing contributes to the dependability in service for which Sperry instruments are noted. The instrument is fastened to the shake table of the exciter, which is controlled from panel. Amplitude, velocity and acceleration are being read directly on an MB Vibration Meter.

WHEN PRODUCTS GIVE unexpected trouble in service, you'll find too often that it's due to vibration.

Foresighted concerns take no chances with this enemy of equipment life. At Sperry Gyroscope Company, possible troubles due to vibration are ferreted out in the laboratory. By means of an MB Vibration Exciter, which has quick, easy adjustments for force and frequency, instruments are checked for vibratory response—for ability to resist fatigue. Result: Trouble is eliminated in the design stage, *before* it starts.

This shaker is adaptable to countless situations. You can test miniature electrical assemblies to mammoth wing structures; filaments to heavy axle shafts. In one of its jobs—fatigue testing—the shaker reproduces vibratory effect of years within hours. One company, for example, reduced the time of spot-checking bellows to 10 minutes—a job which formerly took 12 hours per unit!

Location of noise sources . . . actual observation of the motions of vibrations . . . study of damping characteristics of materials . . . these are but a few other important jobs where an MB Exciter pays off.

Models which deliver forces of 5, 25, 50, 100, 200, 300 and 2500 pounds are available—all electromagnetic. These exciters are suitable for vibration testing equipment to USAF specifications 41065-B and MIL-E-5272. Write us for details.

**The Model S3 Vibration Exciter** illustrated delivers peak force of 200 pounds. Operates in frequency range of 3 to 500 C.P.S. Has rotating power supply. Write us for more detailed information on MB Vibration Exciters, and ask for bulletin 410-M5.

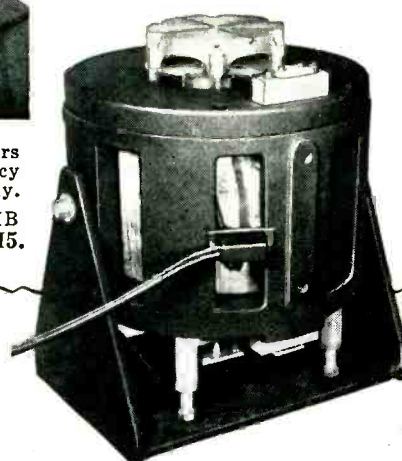

THE **MB** MANUFACTURING COMPANY, Inc.  
1060 State Street, New Haven 11, Conn.

PRODUCTS AND EQUIPMENT TO CONTROL VIBRATION . . . TO MEASURE IT . . . TO REPRODUCE IT



**Announcing**



# WAVEGUIDE TEST EQUIPMENT

**2,600 to 18,000 mc!**

The revolutionary new *-hp-* waveguide test equipment shown on the following pages represents the practical, economical adaptation of a new, fresh concept of waveguide instrumentation. Emphasis throughout is on functional simplicity and low cost; instruments are offered as individual basic components. Most equipment is based on entirely new designs developed either in the *-hp-* laboratories

or by Varian Associates, microwave equipment and electron tube specialists.

Full frequency coverage from 2,600 mc to 18,000 mc is offered in 6 waveguide sizes: 3" x 1½", 2" x 1", 1½" x ¾", 1¼" x ⅝", 1" x ½", .702" x .391". Instrumentation is now available in most of these sizes. Complete instrumentation for these frequencies will be provided during the forthcoming year.

**HEWLETT-PACKARD COMPANY**

2178A PAGE MILL ROAD • PALO ALTO, CALIFORNIA, U.S.A.

Sales Representatives in all principal areas.

Export: Frazar & Hansen, Ltd., San Francisco, Los Angeles, New York City



# Broad-Band Waveguide Test Equipment!

## -hp- 809/810 Slotted Sections

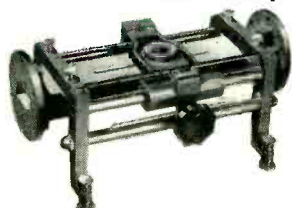

Slotted sections are one of the most important measuring instruments in waveguide engineering. They are essential to the measurement of impedance, reflection and other transmission characteristics.

A single precision carriage (-hp- 809B) mounts either slotted waveguide sections or coaxial sections covering the frequency range from 4.0 to 12.4 kmc. This results in maximum flexibility and minimum cost for complete frequency coverage. The carriage travels on a new 3-point, ball-bearing suspension system; and waveguide or coaxial slotted sections may be quickly interchanged. Carriage operates in conjunction with -hp- 442A Broad-Band Probe and -hp- 440A Coaxial Detector. -hp- 810B Waveguide Slotted Sections are available in sizes: 2" x 1", 1½" x ¾", 1¼" x ⅝", 1" x ½". -hp- 806A Coaxial Slotted Section is available for frequency range 3.0 kmc to 12.0 kmc. -hp- S810A Waveguide Slotted Section, of conventional design, is available in size 3" x 1½" to cover the frequency range 2.6 to 3.9 kmc.

## -hp- 280A, 281A Adaptors, Waveguide to Coaxial



For transition between waveguide and coaxial systems. Each adaptor covers the full waveguide range with a VSWR not exceeding 1.5. -hp- 280A with flexible cable, 3" x 1½" only. -hp- 281A, with Type N Jacks, sizes 3" x 1½", 2" x 1", 1½" x ¾", 1¼" x ⅝", 1" x ½".

## -hp- 370 Attenuators, Fixed

Fixed attenuation characteristics of 6, 10 or 20 db. For reducing power level, isolating system units and reducing reflection. Max. VSWR 1.15. Sizes: 3" x 1½", 2" x 1", 1½" x ¾", 1¼" x ⅝", 1" x ½", .702" x .391".

## -hp- 375A Attenuators, Variable Flap



For introducing variable power differences in a waveguide, or isolating power sources and loads. Consists of slotted waveguide section in which matched plate is moved. Max. VSWR 1.15. Sizes: 3" x 1½", 2" x 1", 1½" x ¾", 1¼" x ⅝", 1" x ½", .702" x .391".

## -hp- 380A Attenuators, Calibrated Variable

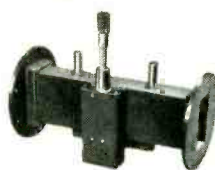

For use between 2,600 and 3,950 mc to create known attenuations or isolate sources and loads. Each instrument accurately calibrated at 3,000 mc. Max. VSWR 1.15. Sizes: 3" x 1½". (Other sizes to be announced.)

## -hp- 485A Detector Mounts



For measurement of power between frequencies 2.6 to 18.0 kmc in conjunction with -hp- 430A Power Meter and Sperry 821 barretter. Also may be employed to measure relative level, or detect rf energy using a Type 1N21 crystal. Each mount is semi-tuned by means of a movable short. Additional tuning may be provided if desired by means of -hp- 870A Slide Screw Tuner or -hp- 880A E-H Tuner. Sizes: 3" x 1½" (for use with barretter only), 2" x 1", 1½" x ¾", 1¼" x ⅝", 1" x ½", .702" x .391".

## -hp- 840A, 841A Waveguide Tees

Rectangular series or shunt tees for coupling waveguide systems, as when dividing power or introducing impedances. Model 840A Series Tees branch from wide face of waveguide. Model 841A Shunt Tees branch from narrow face. Sizes: 3" x 1½", 2" x 1", 1½" x ¾", 1¼" x ⅝", 1" x ½", .702" x .391".

**Providing a new standard of broad-band operation plus traditional -hp- speed, accuracy, convenience and economy, for all types of precision microwave measurements.**



BOOTHS 40, 41

**See this new equipment at the I.R.E. Show or write your -hp- sales representative or factory for details.**

## -hp- 845A Hybrid Tees



Four-arm, rectangular hybrid tee. Composed of series and shunt tee constructed at same point in waveguide. Possess many properties of bridge circuit. Used for rapid determination of VSWR; as impedance transformer; as a bridge, etc. Sizes: 3" x 1½", 2" x 1", 1½" x ¾", 1¼" x ⅝", 1" x ½", .702" x .391".

## -hp- 920A Adjustable Shorts



Adjustable choke-type short for tuning or introducing reactance in combination with detecting sections, series, shunt or hybrid tees. Sizes: 3" x 1½", 2" x 1", 1½" x ¾", 1¼" x ⅝", 1" x ½", .702" x .391".

**HEWLETT-PACKARD  INSTRUMENTS**

# Simple Design, Multi-Purpose Operation!



## -hp- 715A Klystron Power Supply

Versatile power supply for operation of all types of low-power klystron oscillators in test-bench experiments. Beam voltage 250 to 400 v. at 50 ma. max. Reflector voltage 10 to 900 v. at 5  $\mu$ amps. Internal square wave modulation, 1,000 cps; also provision for external modulation. 6.3 volt, 1.5 amp. filament supply.

## -hp- 530A Frequency Meters

General purpose reaction type frequency meter covering the entire waveguide frequency band. Consists of a high "Q" resonant cavity tuned by a plunger. Micrometer scale indicates plunger position. Accuracy  $\pm 0.10\%$ . Ranges: 5.85 to 8.20 kmc ( $1\frac{1}{2}'' \times \frac{3}{4}''$ ) and 8.2 to 12.4 kmc ( $1'' \times \frac{1}{2}''$ ). (Other sizes to be announced.)

## -hp- 870A Slide Screw Tuners

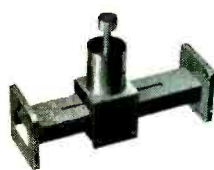

For flattening waveguide systems. Consists of slotted waveguide section and adjustable probe on sliding carriage. Varying position and penetration of probe sets up VSWR which can be adjusted to cancel existing VSWR in system. VSWR values up to 20 can be tuned with an accuracy of VSWR 1.02. Sizes:  $3'' \times 1\frac{1}{2}''$ ,  $2'' \times 1''$ ,  $1\frac{1}{2}'' \times \frac{3}{4}''$ ,  $1\frac{1}{4}'' \times \frac{5}{8}''$ ,  $1'' \times \frac{1}{2}''$ ,  $.702'' \times .391''$ .

## -hp- 880A E-H Tuners

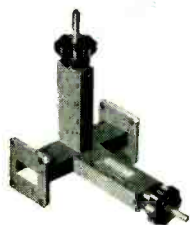

Matching section for tuning high power systems or for tuning systems where low leakage is essential. Consists of hybrid waveguide tee with moveable choke type shorts placed in shunt and series arms. Sizes:  $3'' \times 1\frac{1}{2}''$ ,  $2'' \times 1''$ ,  $1\frac{1}{2}'' \times \frac{3}{4}''$ ,  $1\frac{1}{4}'' \times \frac{5}{8}''$ ,  $1'' \times \frac{1}{2}''$ ,  $.702'' \times .391''$ .

## -hp- 440A Coaxial Detector



-hp- 440A Coaxial Detector, a tunable crystal and bolometer mount, may be used as an rf detector for coaxial systems operating over the frequency range, 2.4 kmc to 12.4 kmc. A single adjustment provides rapid tuning. Equipment mates with Type N connectors and operates either with silicon crystal or bolometer.

## -hp- 442A Broad-Band Probe

This probe may be combined with -hp- 440A to provide a highly sensitive, easily tuned detector for use with slotted sections. A micrometer depth adjustment provides quick control of rf coupling. This combination is specifically designed to operate with -hp- 809B and 810A/B Slotted Waveguide equipment.



## -hp- 910A Low Power Terminations

For use wherever matched load is required, as in measurement of reflection, discontinuities or where waveguide must be properly terminated. Consists of tapered piece of resistive material terminating a waveguide section in its characteristic impedance. Max. VSWR 1.06. Average power 1 watt, sizes:  $3'' \times 1\frac{1}{2}''$ ,  $2'' \times 1''$ ,  $1\frac{1}{2}'' \times \frac{3}{4}''$ ,  $1\frac{1}{4}'' \times \frac{5}{8}''$ . Average power 1/2 watt, sizes:  $1'' \times \frac{1}{2}''$ ,  $.702'' \times .391''$ .

## -hp- 912A High Power Terminations

Used as dummy loads for high-power transmitters. Dissipate large amounts of power without undesirable reflection. VSWR less than 1.1. Forced air cooling required when operating at 50% rating or above. 250 watts average power, size:  $3'' \times 1\frac{1}{2}''$ . 100 watts average power,  $1'' \times \frac{1}{2}''$ . (Other sizes to be announced.)



In addition to waveguide equipment shown on these pages, -hp- offers the basic coaxial equipment used in major microwave research and development projects throughout America.

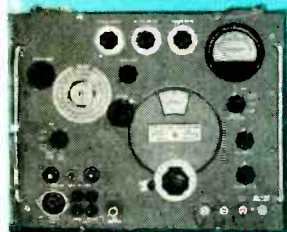

-hp- 616A UHF Signal Generator  
1,800 to 4,000 mc. Output range 0.1  $\mu$ v. to 0.223 v. (1 mw). Continuously variable, direct reading, no adjustments during operation.



-hp- 618A SHF Signal Generator  
3,800 to 7,600 mc. Output range 2.23  $\mu$ v. to 0.223 v. (1 mw). Continuously variable, direct reading, no adjustments during operation.



-hp- 805A/B Slotted Line  
Highly stable, exclusive, parallel plane design. 500 mc to 4000 mc. Model 805A, VSWR 1.04, 50 ohms impedance for flexible cables; 805B, VSWR 1.02, 46.3 ohms impedance, for  $\frac{3}{8}''$  rigid coaxial line.



-hp- 430A Microwave Power Meter  
Automatic, instantaneous power readings in db or milliwatts. No calculations, no adjustments. Use with any microwave bolometer mount.



-hp- 415A Standing Wave Indicator  
High-gain amplifier operating at fixed audio frequency. Reads VSWR and db direct. 70 db calibrated range. Normal frequency 1,000 cps; others available, 300 to 2,000 cps.

HEWLETT-PACKARD



INSTRUMENTS



# A NEW Insulating Laminate...

## INSUROK\* GRADE T-812

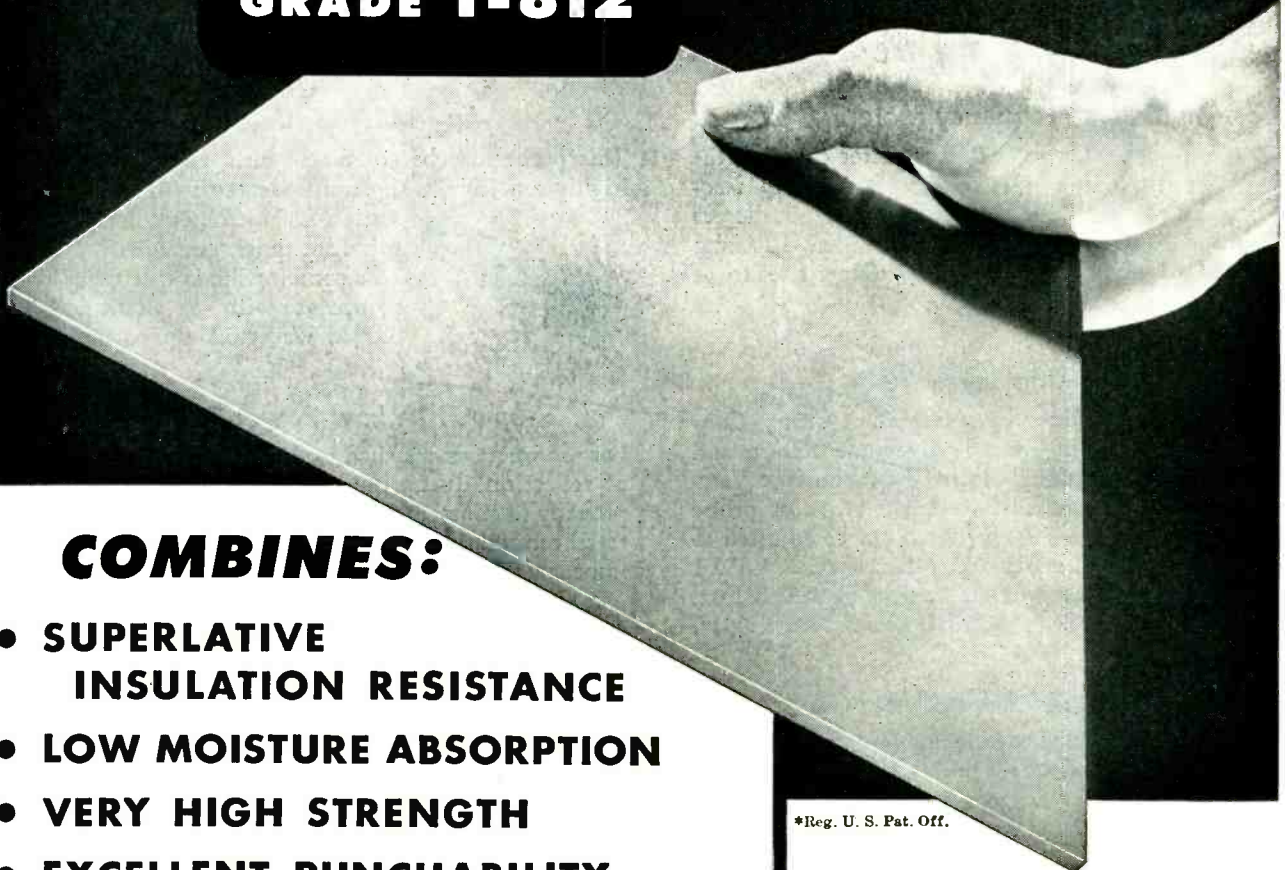

### COMBINES:

- SUPERLATIVE INSULATION RESISTANCE
- LOW MOISTURE ABSORPTION
- VERY HIGH STRENGTH
- EXCELLENT PUNCHABILITY

\*Reg. U. S. Pat. Off.

INSUROK T-812 is a new paper-base punching stock that laughs at heat and humidity! It has outstanding properties that have never before been combined in one insulating laminate. T-812 has excellent electrical characteristics, plus a spectacular ability to retain them through extremes of heat and humidity. Its insulation resistance after humidity conditioning is particularly noteworthy.

INSUROK T-812 retains all of the properties of the well-known INSUROK T-725 and, in addition, has lower moisture absorption and much higher insulation resistance. It punches readily into intricate shapes. Investigate INSUROK T-812 for your product. Information upon request.

### T-812's Property Combination —Unmatched by any other material!

Thickness tested.....	1/16"	
Moisture Absorption (24 hours).....	0.38%	
Expansion after 24 hours' immersion in water at 77°F. Center.....	0.0001"	Edge..... 0.0002"
Tensile Strength, psi.....	Main Direction..... 19,500	Cross Direction..... 14,500
Flexural Strength, psi.....	Main Direction..... 23,000	Cross Direction..... 18,000
Dielectric Strength (perpendicular to laminations) V/Mil, Short Time.....	725 Step by Step..... 625	
	Tests at Room Conditions	After 96 hrs. at 90% Rel. Hum. at 104°F.
Power Factor at 1 megacycle.....	0.028	0.030
Dielectric Constant at 1 megacycle.....	4.4	4.5
Loss Factor at 1 megacycle.....	0.13	0.14
Insulation Resistance, megohms.....	1,000,000	

## The RICHARDSON COMPANY

FOUNDED 1858—LOCKLAND, OHIO.

2797 Lake St., Melrose Park, Illinois (Chicago District)

SALES OFFICES: CLEVELAND • DETROIT  
INDIANAPOLIS • LOCKLAND, OHIO • MILWAUKEE  
NEW BRUNSWICK, (N. J.) • NEW YORK  
PHILADELPHIA • ROCHESTER • ST. LOUIS

WHAT YOU GAIN WHEN YOU BUY...

# HYTRON

*Studio-Matched*

## RECTANGULARS



LEADING TV SET MANUFACTURERS PICK HYTRON RECTANGULARS:  
 ADMIRAL • AIR KING • BENDIX • CROSLEY • EMERSON  
 HALLICRAFTERS • HOFFMAN • MOTOROLA • NATIONAL  
 OLYMPIC • SENTINEL • SETCHELL-CARLSON • SPARTON  
 STROMBERG-CARLSON • TRAV-LER • WESTINGHOUSE  
 AND OTHERS

- 1 You get **THE ORIGINAL**. The *studio-matched* rectangular tube is Hytron's baby. Its logically designed screen matches the 4 by 3 aspect ratio of the studio picture. Quite naturally, Hytron's new rectangular is fast becoming the most popular picture tube.
- 2 You get **UNIFORMITY**. Hytron's new picture-tube plant is the most modern in the world. It was designed especially to mass-produce Hytron *studio-matched* rectangulars of uniform dependability.
- 3 You get **A COMPLETE LINE**. Hytron offers you 14-, 16-, 17-, and 20-inch *studio-matched* rectangulars. All the popular rectangulars (and the popular types of round tubes too).
- 4 You get **THE QUALITY LEADERS DEMAND**. Nine out of ten leading TV set makers choose Hytron. More and more leading service-dealers pick Hytron. Because their own experience proves Hytron *studio-matched* rectangulars give "amazingly clearer, sharper, more brilliant pictures." Demand this same performance for yourself. Demand original Hytron *studio-matched* rectangulars.



MAIN OFFICE: SALEM, MASSACHUSETTS



# Here's Fairchild's Newest Potentiometer!

## TYPE-746 PRECISION POTENTIOMETER OFFERS:

- Low Torque
- Accurate Phasing
- Quick Replacement
- Ganging up to 20 on a shaft

The finest we've ever built! That's our idea of the new "746". It's got lower torque, a new more accurate phasing adjustment, and a new method of ganging that makes it easy to put as many as twenty cups on a single shaft. Individual cups in a gang are easily replaced if necessary.

The new potentiometer is available with linear or non-linear windings to meet your specifications. Its attractive case is made of grey anodized aluminum.

The "746" is just one of the complete Fairchild family of precision potentiometers. What are your requirements? Write, giving details, to *Fairchild Camera and Instrument Corporation, 88-06 Van Wyck Boulevard, Jamaica 1, N. Y. Dept. 140-13A.*

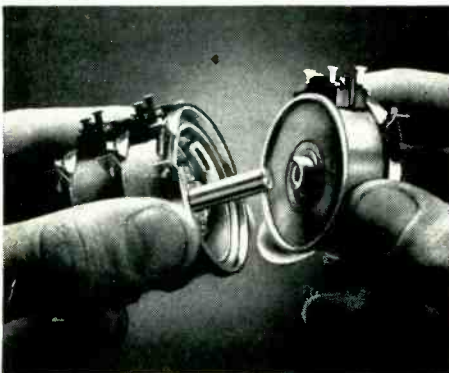
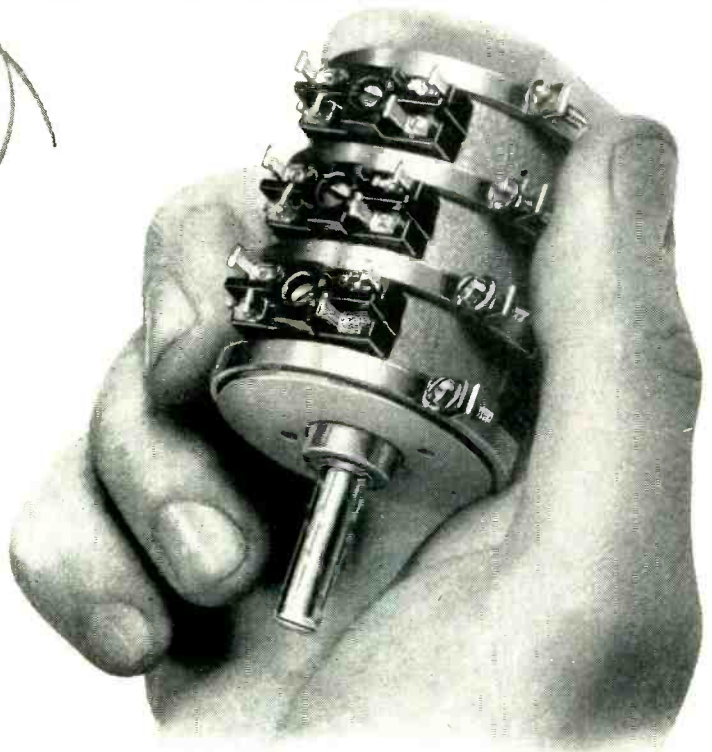

### EASY REPLACEMENT

To replace a unit in a "746" gang, loosen connecting-band screws, remove "cup," slip new "cup" under bands, and tighten screws. This feature pays off in experimental work where circuit elements are changed periodically.

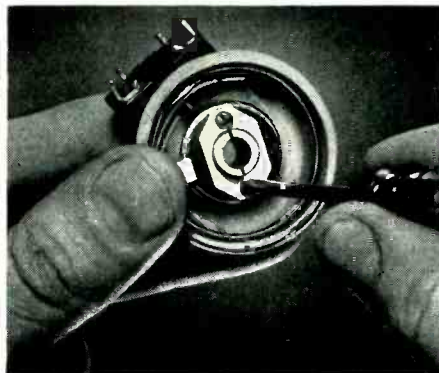

### ACCURATE PHASING

A new type phasing adjustment is simpler and more accurate. A retainer plate clamps shaft to wiper arm. To adjust for phasing, loosen two screws, set the arm to the correct position, then tighten screws.

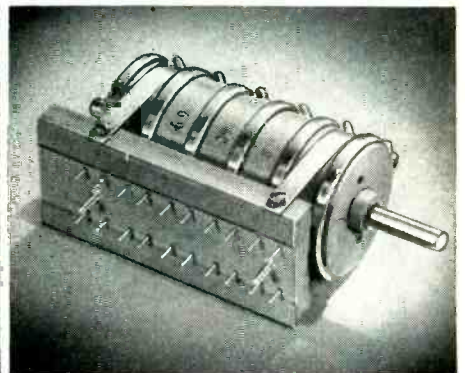

### FLEXIBLE DESIGN

Typical of the special consideration Fairchild gives to its customers' special requirements is this plug-in version of the "746." Where fast servicing is a must, the advantages of this "quick-change" unit are quite apparent.

### SPECIFICATIONS

**Accuracy (overall resistance)**— $\pm 0.5\%$  (linear),  $\pm 1.0\%$  or better (non-linear)  
**Mechanical accuracy**—  
 concentricity (shaft to pilot)—.0015 in. FIR max.;  
 radial play—.0009 in. FIR max.;  
 shaft—centerless ground stainless steel to .2500 diam. (+.0000, -.0005 in.);  
 pilot hub—machined to .5000 (+.0000, -.0005 in.)  
**Torque**—1.5 oz.-in.  
**Dimensions**—diameter 1.750 max.; length (1 cup) .800 in.  $\pm 0.009$  in.; added length per unit ganged .580 in.  $\pm 0.002$  in.  
**Case**—grey anodized aluminum

**FAIRCHILD**  
**PRECISION POTENTIOMETERS**

SEE THE TYPE 746 AND OTHER FAIRCHILD PRECISION POTENTIOMETERS AT THE RADIO ENGINEERING SHOW, BOOTH 238-239



# TAKE A MICROSECOND LOOK AT A PROJECTILE IN FLIGHT

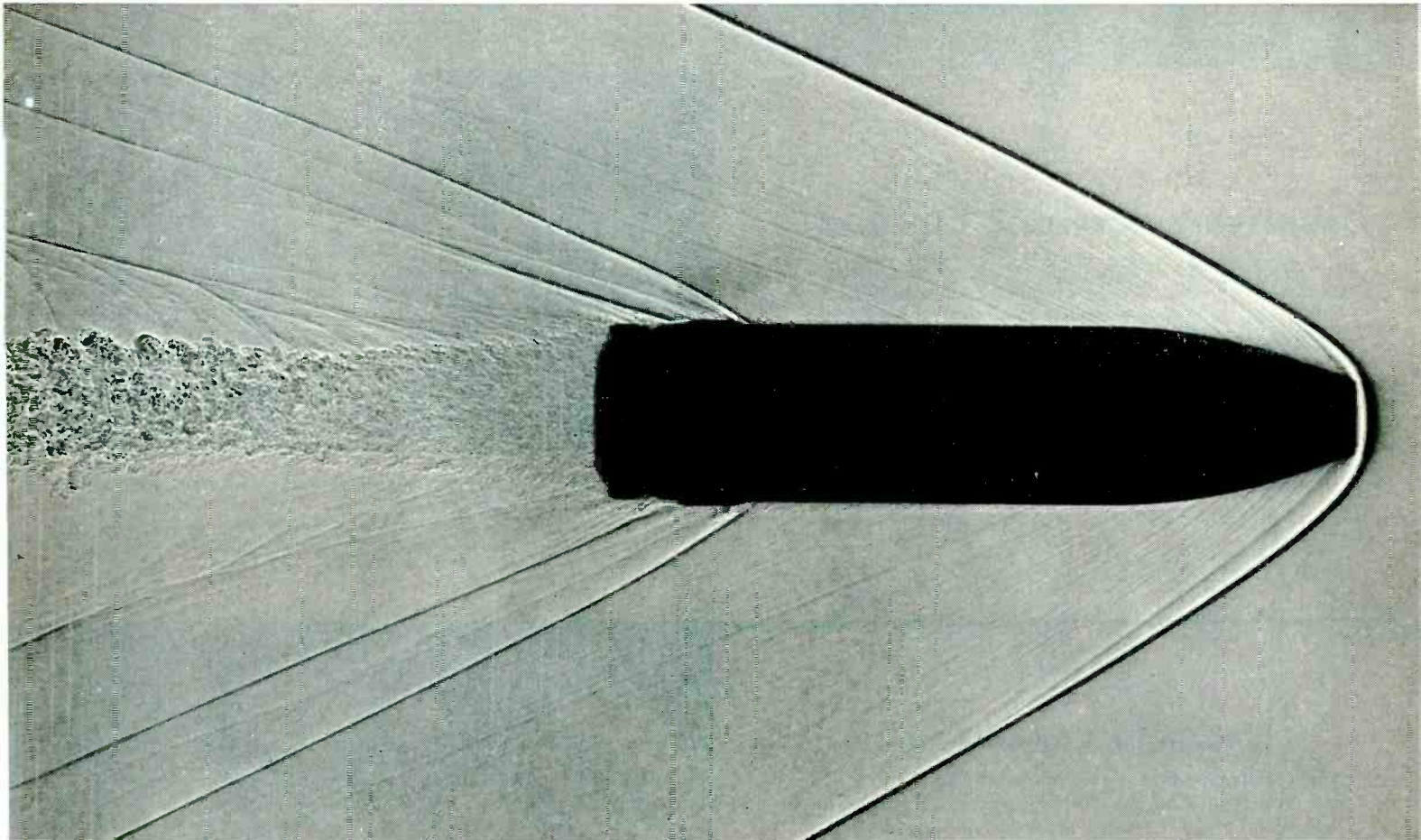

Velocity of projectile: Approx. 2800' per second. Duration of spark light:  $12 \times 10^{-7}$  second.

## How Centralab Engineers solved a problem in Electronics for Ultra-High Speed Photography

### CERAMIC TUBULAR DIELECTRIC REPLACES 30' OF STANDARD SOLID DIELECTRIC COAXIAL CABLE— LIGHT INTENSITY BETTERED 900 TIMES



Former Method

Ultra-speed photographs are taken with the light of an electric spark. Former method used 30 feet of co-axial cable transmission line — charged with 10,000 V.—and discharged across a spark gap.

To replace the bulky cable, Centralab developed a tubular ceramic condenser (2" O.D. x 6 1/2" long) with silver electrodes fired to the inner and outer surfaces. The condenser is charged (to 10KV) and discharged exactly like the cable — *however with a gain in light intensity of 900 times!* Characteristics of the new Centralab ceramic condenser are:



Centralab Condenser

Dielectric Constant.....	6000 at 1 megacycle
Capacity .....	24,000 mmf.
Velocity propagation .....	.027 x velocity propagation in air.
Impedance .....	Approx. 1 Ohm
Decay time, peak to 1/e peak.....	$2 \times 10^{-7}$ second
Rise time, 0 to peak.....	$1 \times 10^{-7}$ second
50% of peak limits.....	$1.8 \times 10^{-7}$ second

CENTRALAB engineers know their electronics and ceramics! This single ceramic development greatly advanced the photo-study of turbulence, ultra-sonic wave structure, and other high-speed phenomena. But this is just one of literally thousands of electronic component problems solved by Centralab. For Centralab engineers have compounded and tested over 20,000 different ceramics. So if you have a problem in electronics — in radio or radar . . . in TV, FM or X-ray — that Centralab Ceramics might solve . . . don't hesitate, call us in today!

You won't regret it for Centralab is the industry's pioneer in Printed Electronic Circuits and carbon controls — the leader in the industry for the widest variety of fine quality ceramic capacitors — high voltage, by-pass coupling or temperature compensating types — in flat, tubular, disc or cylindrical shapes.

Photograph and its technical data is gratefully accredited to Dr. J. C. Hubbard, Messrs. J. A. Fitzpatrick and W. J. Thaler, Dept. of Physics, Catholic U., Washington, D.C.

For more **Centralab** developments that can help you ➡



# Centralab Components

See them at the I.R.E. SHOW — Booths 232-33

## PRINTED ELECTRONIC CIRCUITS

— Are complete or partial circuits (including all integral circuit connections) consisting of pure metallic silver and resistance materials fired to CRL's famous Steatite or Ceramic-X and brought out to convenient, permanently anchored external leads. They provide compact miniature units of widely diversified circuits — from single resistor plates to complete speech amplifiers. No other modern electronic development offers such tremendous time and cost saving advantages in low-power applications.

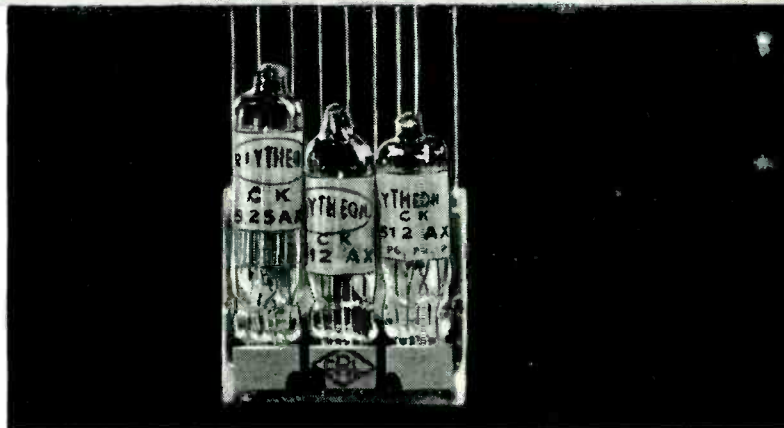

Ampec is a full 3-stage, 3-tube speech amplifier. Gives you truly highly efficient reliable performance. Size: 1 1/4" x 1 1/8" x .340" over tube sockets! Widely used in hearing aids, mike preamps and other amplifier applications where small size and outstanding performance counts. Bulletin No. 973 in coupon below.

## CERAMIC CAPACITORS

Centralab ceramic capacitors give you permanence never before achieved with old-fashioned paper or mica condensers. Ceramics are impervious to moisture, and have unmatched ability to withstand any temperatures normally encountered in electrical apparatus. Ceramics make possible tremendous space saving; many Centralab ceramic capacitors are 1/7th the size of ordinary capacitors. You can rely on Centralab ceramic capacitors for close tolerance, high accuracy, low power factors, and excellent temperature compensating qualities.



High voltage ceramic capacitors. Capacitance: 5 to 500 mmf., 5 KV to 40 KV D.C. working. Ideal for portable or mobile equipment. Primarily designed for high voltage, high frequency gear. For complete information, check Bulletin No. 42-102 in coupon below.

## SWITCHES AND CONTROLS

Look to Centralab for standard and special purpose switches — single or multi-section (phenolic or steatite) — single or multi-pole — rotary, slide or lever action — shorting or non-shorting contacts . . . for AM-FM-TV as well as for medium duty power applications. In controls — it's Centralab all the way . . . for Centralab introduced Carbon controls to the electronic industry 25 years ago! New Model 2 Radiohms are America's most modern controls for TV-AM-FM. Centralab Model 1 Radiohm is the outstanding truly miniature unit—the standard of the hearing aid industry.

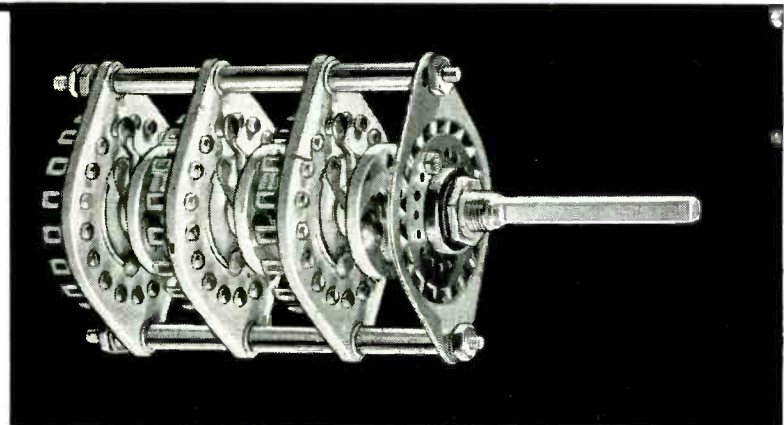

Medium Duty Power Switch for R.F. or 7 1/2 amp. 110-115 V. application. 1, 2 or 3 poles . . . 18 contact sections . . . up to 20 sections per shaft. Contacts, collector rings coin silver mounted on Grade L5 Steatite. Cat. No. 722.

# for all Electronic Gear

New York City, Grand Central Palace. March 19-22

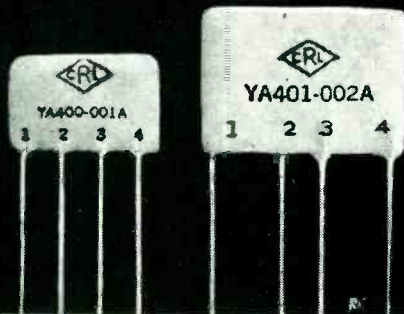

Centralab Triode Couplates save space and weight. They actually replace 5 components normally used in audio circuits. Triode Couplates are complete assemblies of 3 capacitors and 2 resistors bonded to a dielectric ceramic plate. Available in a variety of resistor and capacitor values. Bulletin No. 42-6 in coupon below.

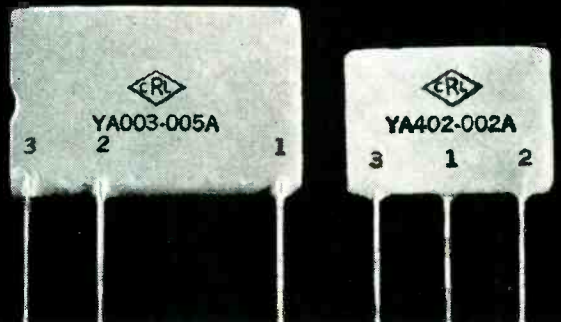

Centralab Vertical Integrators give you big savings in assembly costs, particularly in TV vertical integrator networks. One type consists of 4 resistors and 4 capacitors brought out to 3 leads . . . reducing the formerly required 16 soldered connection to only 3! There's a big saving in the number of parts handled, too! Bulletin No. 42-22.

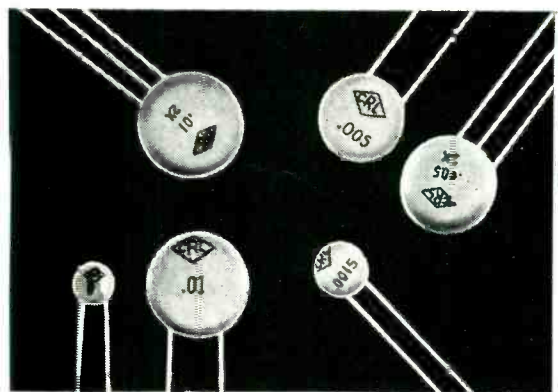

Ceramic Disc Hi-Kap Capacitors hold thickness to a minimum. Make possible very high capacity in extremely small size. Use in HF bypass and coupling. Bulletin No. 42-4R.

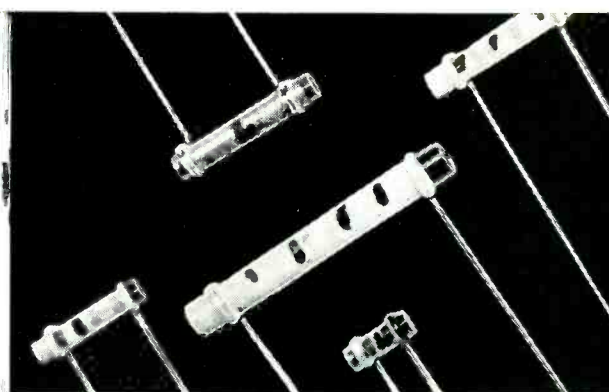

Tubular Ceramic Capacitors — Type TCZ show no capacitance change over wide range of temperature. Type TCN have special ceramic body to vary capacitance according to temperature. Bulletin No. 42-18.

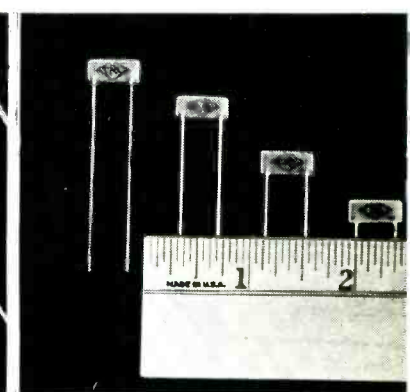

Min-Kaps are very tiny capacitors used where space is at an extreme premium. Ask for Bulletin No. 42-24.



New high quality Model 2 Radiohms are designed for lower noise level, longer life. Bulletin No. 42-85.

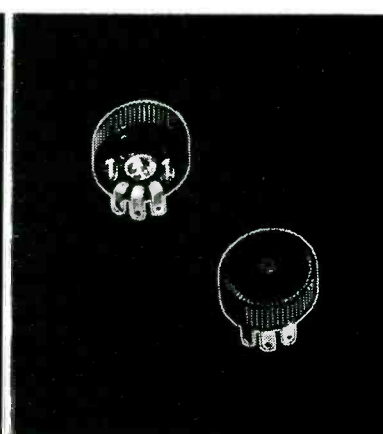

Model "1" Radiohm control — 1/40 watt — plain or switch type. No larger than a dime. For miniature use. Bulletin No. 42-19.

## Centralab

Division of GLOBE-UNION INC. • Milwaukee

TEAR OUT COUPON  
for the Bulletins you want

### CENTRALAB

Division of Globe-Union Inc.  
914 East Keefe Avenue, Milwaukee, Wisconsin

Yes — I would like to have the CRL bulletins, checked below, for my technical library!

- 973    42-6    42-22    42-102    42-4R    42-18  
 42-24    722    42-85    42-19

Name.....

Address.....

City..... State.....



THE MUSHROOM-LIKE OBJECT directly below is the completed assembly of the radio volume control shaft made by P. R. Mallory & Co., Inc., Indianapolis, Ind., (actual size). Photo below it shows the plastic part attached by a staking operation. This staking is shown in detail in photo of part enlarged 7 times, at right. Photo at bottom shows control shaft after machining and before staking. Shaft is made from Revere Alloy 247 . . .  $\frac{1}{4}$ " round free cutting brass rod.

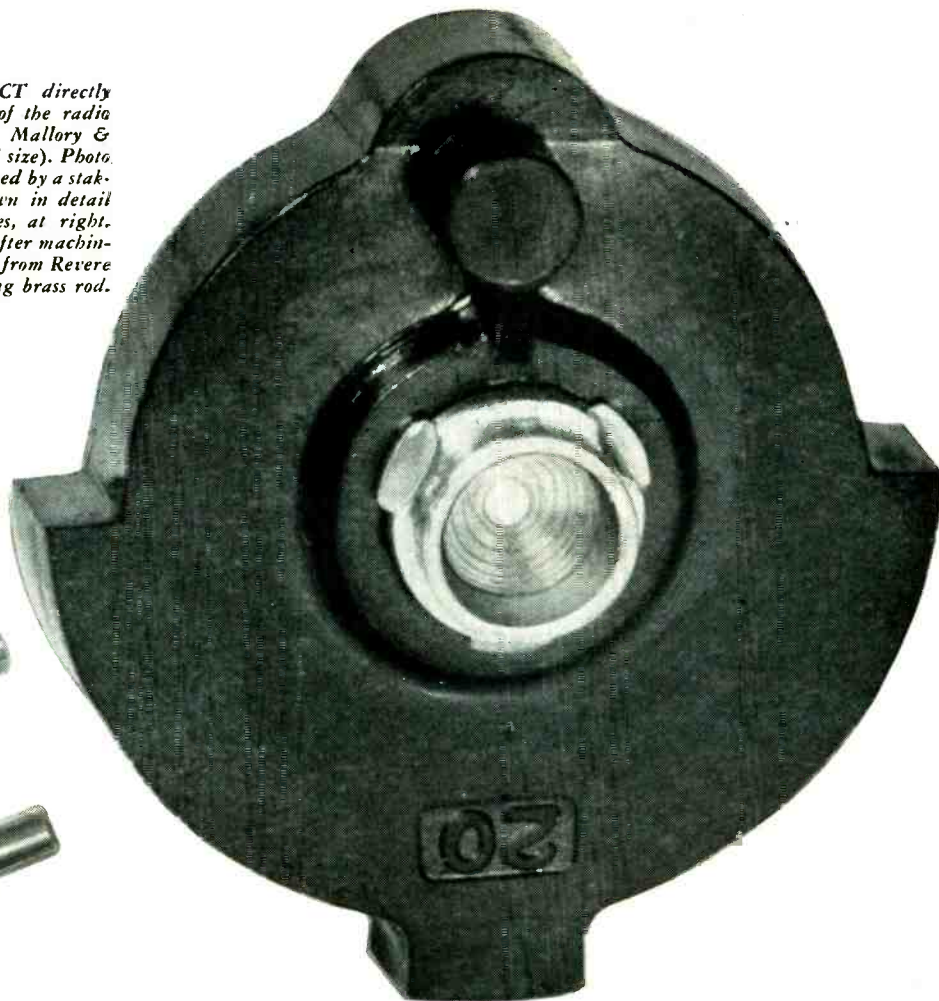

**BY SWITCHING TO REVERE FREE CUTTING  
BRASS ROD P. R. MALLORY & CO., INC.,**

***SAVES ON 2 COUNTS!***

Staking operation on radio volume control shaft performed without fracture . . . annealing operation eliminated.

The solution to the Mallory Company's problem was not as easy as it might appear. It was not simply a case of Revere Technical Advisory Service recommending  $\frac{1}{4}$ " round, free cutting brass rod. That rod had to possess the machinability to match Mallory's existing production machine set-up and at the same time be sufficiently workable so that annealing, prior to staking, could be eliminated; and that staking be accomplished without fracturing the metal.

After consulting with the Mallory Engineers, and discussing the tests which Mallory would subsequently conduct, Revere recommended a  $\frac{1}{4}$ " round, half hard riveting and turning rod mixture 247. Working tests made by Mallory showed this rod to possess all the necessary requirements.

As a result of those tests, P. R. Mallory & Company

is now using this Revere free cutting brass rod to its complete satisfaction for the radio volume control shafts it manufactures. Not just any  $\frac{1}{4}$ " brass rod, but the *right* rod made it possible for them to save on 2 counts.

Perhaps Revere has a brass, a copper or some special alloy to help you in the development or improvement of your product . . . in cutting your production costs. So why not tell Revere *your* metal problems? Call the Revere Sales Office nearest you today.

**REVERE** *150<sup>th</sup> YEAR OF SERVICE TO AMERICA*  
**COPPER AND BRASS INCORPORATED**

Founded by Paul Revere in 1801  
230 Park Avenue, New York 17, N. Y.

Mills: Baltimore, Md.; Chicago and Clinton, Ill.; Detroit, Mich.; Los Angeles and Riverside, Calif.; New Bedford, Mass.; Rome, N. Y.—  
Sales Offices in Principal Cities, Distributors Everywhere.

SEE "MEET THE PRESS" ON NBC TELEVISION EVERY SUNDAY

**The FIRST all-band  
direct reading**

# SPECTRUM ANALYZER

10 MCS to 16,520 MCS



Polarad's Model LSA Spectrum Analyzer is the result of years of research and development. It provides a simple and direct means of rapid and accurate measurement and spectral display of an r.f. signal.

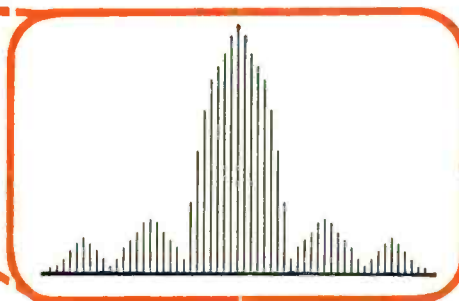

### Outstanding Features:

- Continuous tuning.
- One tuning control.
- 5 KC resolution at all frequencies.
- 250 KC to 25 MCS display at all frequencies.
- Tuning dial frequency accuracy 1 percent.
- No Klystron modes to set.
- Broadband attenuators supplied with equipment above 1000 MCS.
- Frequency marker for measuring frequency differences 0.25 MCS.
- Only three tuning units required to cover entire range.
- Microwave components used latest design non-contacting shorts for long mechanical life.
- Maximum frequency coverage per dollar invested.
- 5 inch CRT display.

### Where Used:

Polarad's Model LSA Spectrum Analyzer is a laboratory instrument used to provide a visual indication of the frequency of distribution of energy in an r.f. signal in the range 10 to 16,520 MCS.

### Other uses are:

1. Observe and measure sidebands associated with amplitude and frequency modulated signals.
2. Determine the presence and accurately measure the frequency of radio and/or radar signals.
3. Check the spectrum of magnetron oscillators.
4. Measures noise spectra.
5. Check and observe tracking of r.f. components of a radar system.
5. Check two r.f. signals differing by a small frequency separation.

**See it at Booth S-7 at the IRE Show**

WRITE DEPT. E-3 FOR COMPLETE DETAILS

# Polarad

Electronics Corporation

100 Metropolitan Ave. Brooklyn 11, N. Y.

**Manufacturers of broadband microwave laboratory instruments.**

*the instrument consists of  
the following units:*

Model LTU-1 R.F. Tuning Unit—10 to 1000 MCS.  
Model LTU-2 R.F. Tuning Unit—940 to 4500 MCS.  
Model LTU-3 R.F. Tuning Unit—4460 to 16,520 MCS.  
Model LDU-1 Spectrum Display Unit.  
Model LPU-1 Power Unit.  
Model LKU-1 Klystron Power Unit.



# DESIGNED FOR

# SERVICE

**More Rugged Electrically  
More Rugged Mechanically  
More Rugged in Safety Factor  
More Rugged for Longer Life**

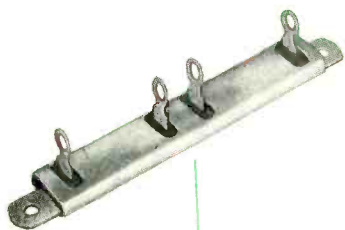

Armor-clad voltage dividers that stand up to mechanical and electrical abuse.

The toughest wire-wound power resistors in use today — Greenohms and Standees.

Dual carbon-element controls with single shaft or with dual concentric shaft.

Constant-impedance L- and T-pads for distortionless volume control of sound systems.

Plug-in ballasts and line-voltage regulators for smoother set operation and protection.

Wire-wound potentiometers with that velvety-smooth mechanical and electrical precision.

Power rheostats "built like a battleship" for dependable control functions.

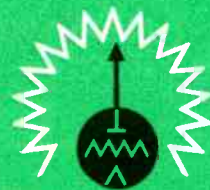
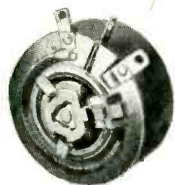
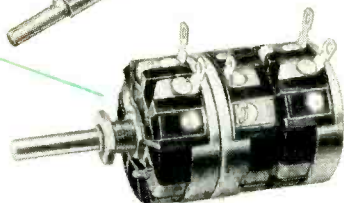
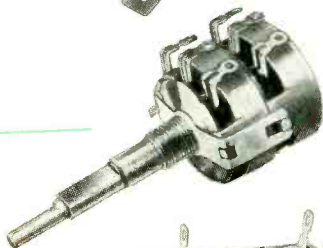

★ A dependable control or resistor costs but a few cents. But an uncertain control or resistor that fails out in the field can cost you thousands of dollars by way of impaired reputation.

The fact that Clarostat controls and resistors are used in the majority of today's TV, radio and electronic assemblies, speaks for itself. Clarostat not only supplies such initial equipment but also the service replacements for the further protection of the manufacturer's good name and good will.

*Designed for Service!* That's precisely what you are demanding and getting, when you simply specify CLAROSTAT for controls and resistors.

# CLAROSTAT

CLAROSTAT MFG. CO., INC. DOVER, NEW HAMPSHIRE

THE **FILTRON** CO., INC.

131-05 Fowler Avenue  
Flushing, Long Island, N. Y.

*Announces the opening of their new  
plant with expanded facilities  
for the manufacture of  
R F Interference Suppression  
Filters exclusively.*

*Complete Facilities:*

- Filter Production
- RF Interference Suppression Engineering and Development
- Screen Room Measuring Laboratories
- Capacitor Manufacturing
- Coil Winding
- Metal Stamping
- Tool and Die Making

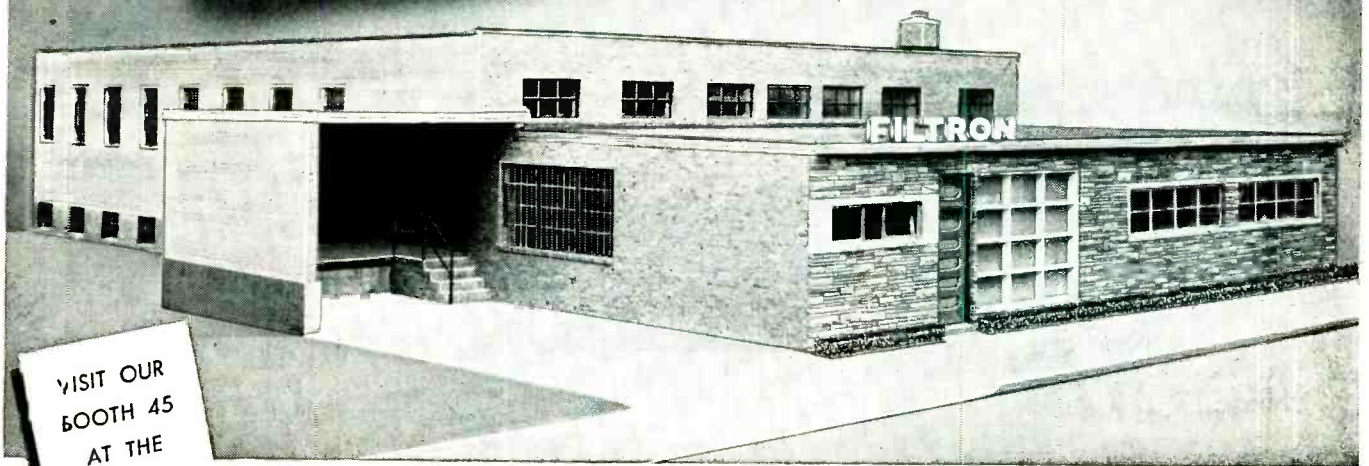

VISIT OUR  
BOOTH 45  
AT THE  
I.R.E. SHOW

THE **FILTRON** CO., INC., FLUSHING, LONG ISLAND, N. Y.

**LARGEST EXCLUSIVE MANUFACTURERS OF RF INTERFERENCE FILTERS**



A  
 RELIABLE SOURCE  
 OF SUPPLY *for*  
 DEPENDABLE RESISTORS  
*for* OVER 20 YEARS

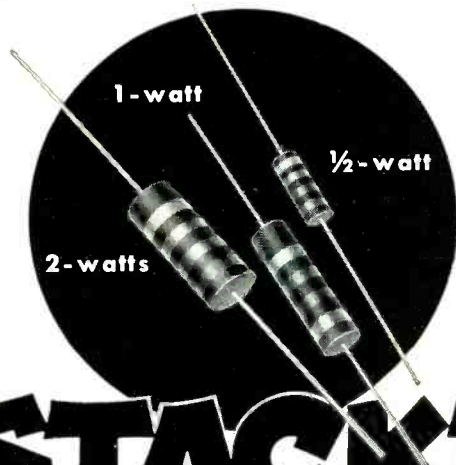

**STACKPOLE**

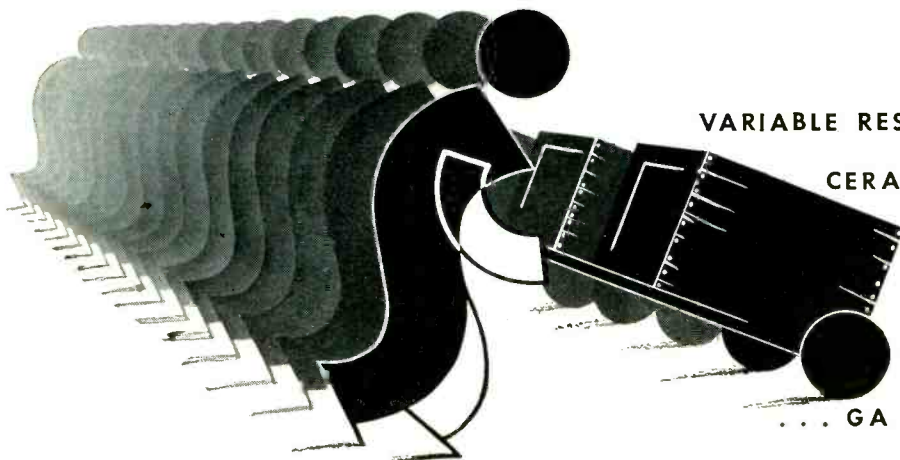

... FIXED RESISTORS

VARIABLE RESISTORS ... IRON CORES ...

CERAMAG® CORES ... LINE, SLIDE

AND ROTARY SWITCHES ...

CARBON VOLTAGE REGULATOR

DISCS ... MOLDED COIL FORMS

... GA "GIMMICK" CAPACITORS, ETC.

*Electronic Components Division*

**STACKPOLE CARBON COMPANY**

**ST. MARYS, PA.**

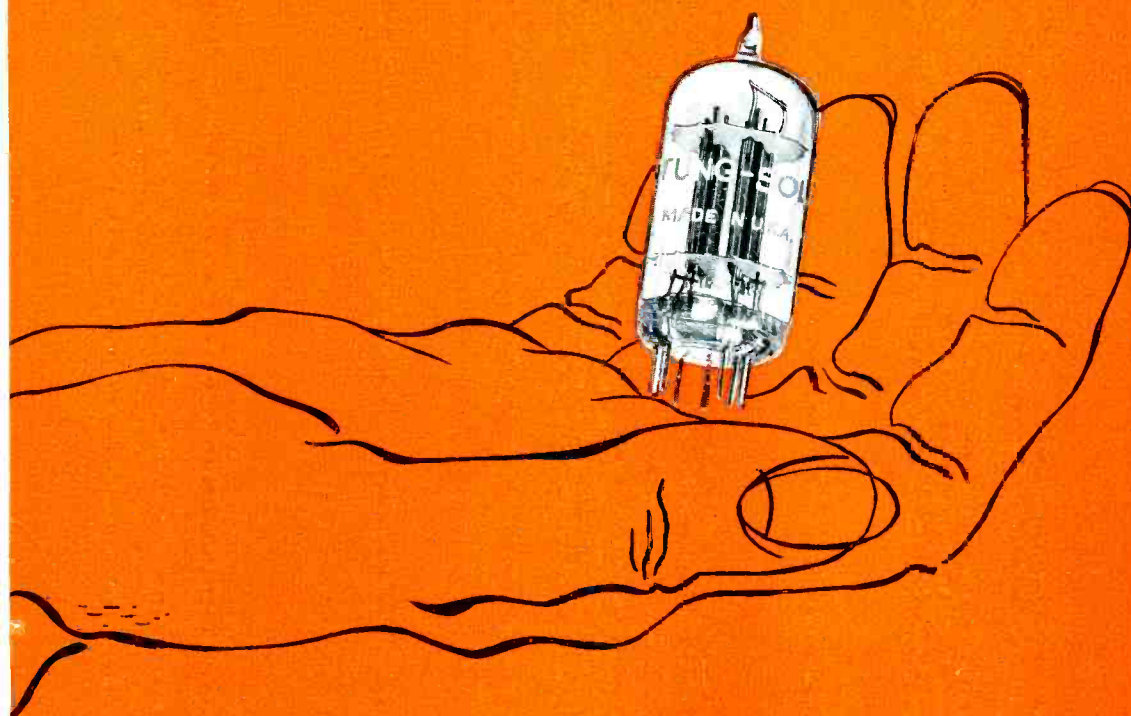

PRECISION, UNLIMITED





## PRECISION BUILT FOR MAXIMUM UNIFORMITY

EVER stop to think of the precision required to engineer an electron tube to the complex requirements of modern circuits? Probably you have. Maybe you have even thought that it must be quite a job to mass-produce so exacting a unit—and by the millions, too! Frankly, it is—quite a job.

The modern electron tube, with its miniature proportions, tiny parts and microscopic tolerances, is an unbelievably critical device. Even the most minute variations in the tube assembly are sufficient to seriously alter performance characteristics.

Therefore, the degree to which those variations are held in check by the tube manufacturer determines the uniformity of their product—a factor of vital importance to set and equipment builders.

*On the following pages are shown some of the tests and inspections that hold TUNG-SOL tubes to quality standards unsurpassed in the electronic industry.*

TUNG-SOL tests and inspections are based on the most modern statistical quality control methods. The more rigid the performance specifications of a tube, the more detailed and exacting are the tests—and always in ample volume to make uniformity of performance a minimum calculated risk. New methods of maintaining ultimate precision are continually being devised so that TUNG-SOL tubes may be always abreast of industry demands.

Naturally quality is not “tested-in”—it is built-in. However, the guarantee of built-in quality is unlimited testing.

**MANUFACTURING TESTS**—These begin with raw materials, which are tested chemically and mechanically.

Hardly a single step of the manufacturing process is without some mechanical or visual test and inspection. There are literally more testing instruments than there are employees.

Parts such as plates and sleeves are compared and graded so that tubes of any one type will have the most uniform performance characteristics possible.

**QUALITY CONTROL TESTS**—Concurrently with manufacture, the Quality Control Department separately tests actuarially-determined sample lots of tubes—both in work and completed.

*Quality Control is completely independent of manufacturing. It has the power to reject tubes that do not meet TUNG-SOL standards or the specifications of a customer.*

The findings of Quality Control, collated by striking new procedures, reflect within minutes the exact quality standards being maintained on any production line. Where sub-standard work begins to show, Quality Control flashes an instantaneous “stop.”

Only those lines maintaining TUNG-SOL's high level of precision, can continue to produce tubes for TUNG-SOL customers—and only after they are certified by Quality Control can TUNG-SOL tubes be shipped.

Thus, by the highest standards of manufacturing, TUNG-SOL guarantees to deliver to its customers the fullest measure of service and performance in every TUNG-SOL tube.

**TUNG-SOL LAMP WORKS INC., NEWARK 4, NEW JERSEY**



**TESTS  
DURING  
MANU-  
FACTURE**



Gas for heat-processing parts is tested for freedom from sulphur—



—and tested again for other specifications. Then refined by cracking—



—and tested still again before use on the Tung-Sol tube parts.



Cleaning solvent is rigidly tested for acidity before it is used.



Washed parts are tested for chemical as well as physical cleanliness, and—



—tested again for freedom from the slightest trace of oil film.



Cathode sleeves, like all other critical parts, are micrometer-checked—



—since dimensional uniformity is vital to electrical performance.



Few dimensions are coarse enough for mere steel-rule checking—



—most checks require micrometers reading to the thousandth-inch or finer.



The comparator tests thousandth-inch accuracy in mica specifications—



—and checks microscopic uniformity of plate details.



The tool-maker's microscope makes hair-sized holes look like circus hoops—



—and measures thickness of grid-wires down to .0001"—



—but it takes an electronic mike to check diameter of the finest wires.



Elongation specifications of wire are minutely tested on this rack.



Checking the "bend value" of wire is highly important for uniformity.



Weight of filament wire is tested on a precision balance reading to .05 MG.



Carbonized nickel plates are chemically analyzed for purity and uniformity.



Chemical analysis checks cathode sleeves against any possible impurity.



Quantitative analysis tests composition of shields, sleeves, metal parts.



Coating baked on filament wire is constantly miked for uniform thickness.



Cathode coating, too, is production-line checked for size—



—and for weight. Tolerances on this critical part are as close as .4 MG.



Finished cathodes for some tubes are micrometer-graded for uniformity.



Completed filaments are always checked before going into production.

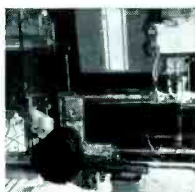

A grid is projected giant-size for inspection.

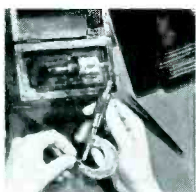

Many grid dimensions are checked to .0001".



Tube envelopes are critically inspected for sealing defects—as well as accuracy of branding.

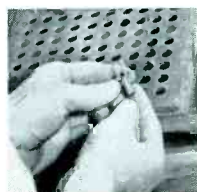

Newly-formed stems are cold-plug checked for glass strains.



It takes a microscope to inspect the seal of lead wires in many stems—



—and a polaroscope to check the strain a stem develops in cooling.



A stem is checked for pin length with a dial micrometer.



Every stem is light-inspected after lead wires are cut and formed.



Tube envelopes are not only inspected but graded by exact size.



Polaroscope examination of tube envelopes checks correct strain pattern.



Inspection under magnification guards against minutest defects.



Precision balance checks findings of precision micrometer.



Completed ments are literally probed during inspection—



—and are tested for shorts before sealing in envelopes.





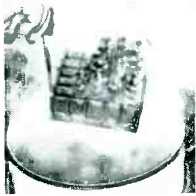

A brute test of ruggedness; cold tubes plunged in boiling water.

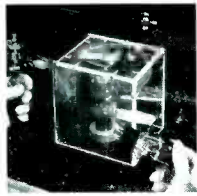

High-voltage (up to 7500V) tests new-sealed tubes.



The aging rack stabilizes characteristics, discloses latent defects.



Progressive tests check every electrical characteristic such as over-all gain—



—grid capacity and other measurables, often to very close tolerances.



Other operators check microphonics, test for hum and noise.

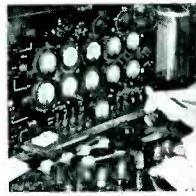

Special test sets check 8 or more characteristics in swift sequence.



**QUALITY CONTROL TESTS**



Torque test instruments check firmness of top cap assembly—



—critical inspectors check the alignment of filaments—



—over-all height must be uniform for every type of tube—



—and angular alignment of base must prove accurate, before—

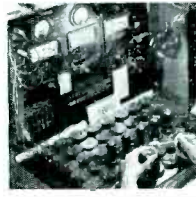

—electrical characteristics, already tested in production, are rechecked—

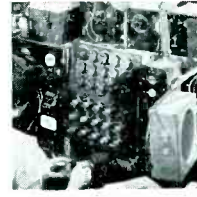

—along with hum and noise. If defects begin showing in any—

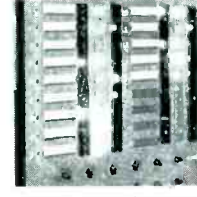

—assembly-line's product the master signal board flashes "Stop."

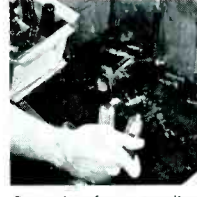

Preparing for a grueling torque test, tubes are soaked 18 hours in hot water—



—and are then wrung against heavy leverage applied to bases.



The polaroscope checks strain pattern in cold-plugged tubes.

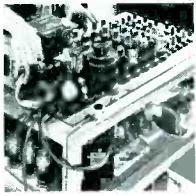

Can tubes stand continuous turning on-and-off? This test tells.

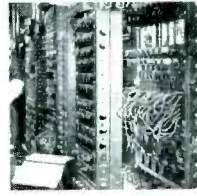

Now starts the 500-hour Life Test, applied to every type of tube.



During the Life Test, tubes are removed periodically and tested for change—

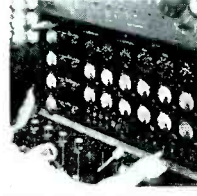

—in an average of 12 electrical characteristics, after which—

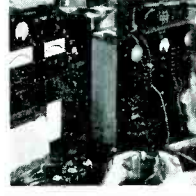

—they are physically inspected and tested all over again.



Platted curves summarize the exhaustive Life Test findings.



Grid-emission is tested—especially in mobile-set tubes.

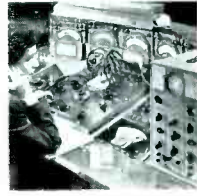

Elaborate instruments—including oscilloscope—test design characteristics—



—while others check filament current and heater-cathode leakage.



A capacitance bridge measures direct inter-electrode capacities.

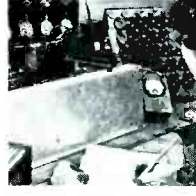

The famous vibration test, important for mobile-set tubes.



Finally, right before shipment tubes are again tested for shorts after a drop test.

*You can't buy a better tube than*  
**TUNG-SOL**

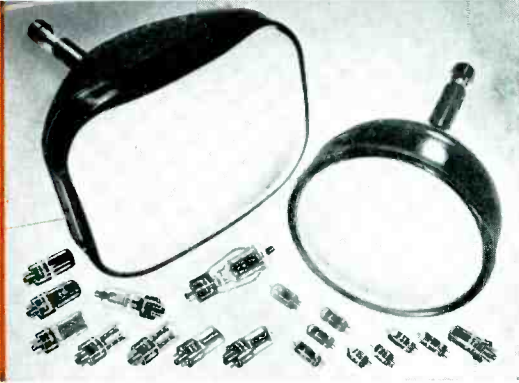

**TUNG-SOL LAMP WORKS INC., Newark 4, N. J.**

Sales Offices: Atlanta • Chicago • Dallas • Denver • Detroit • Los Angeles • Newark  
Television Tubes • Radio Tubes • Dial Lamps • Also All-Glass Sealed Beam Lamps and Signal Flashers

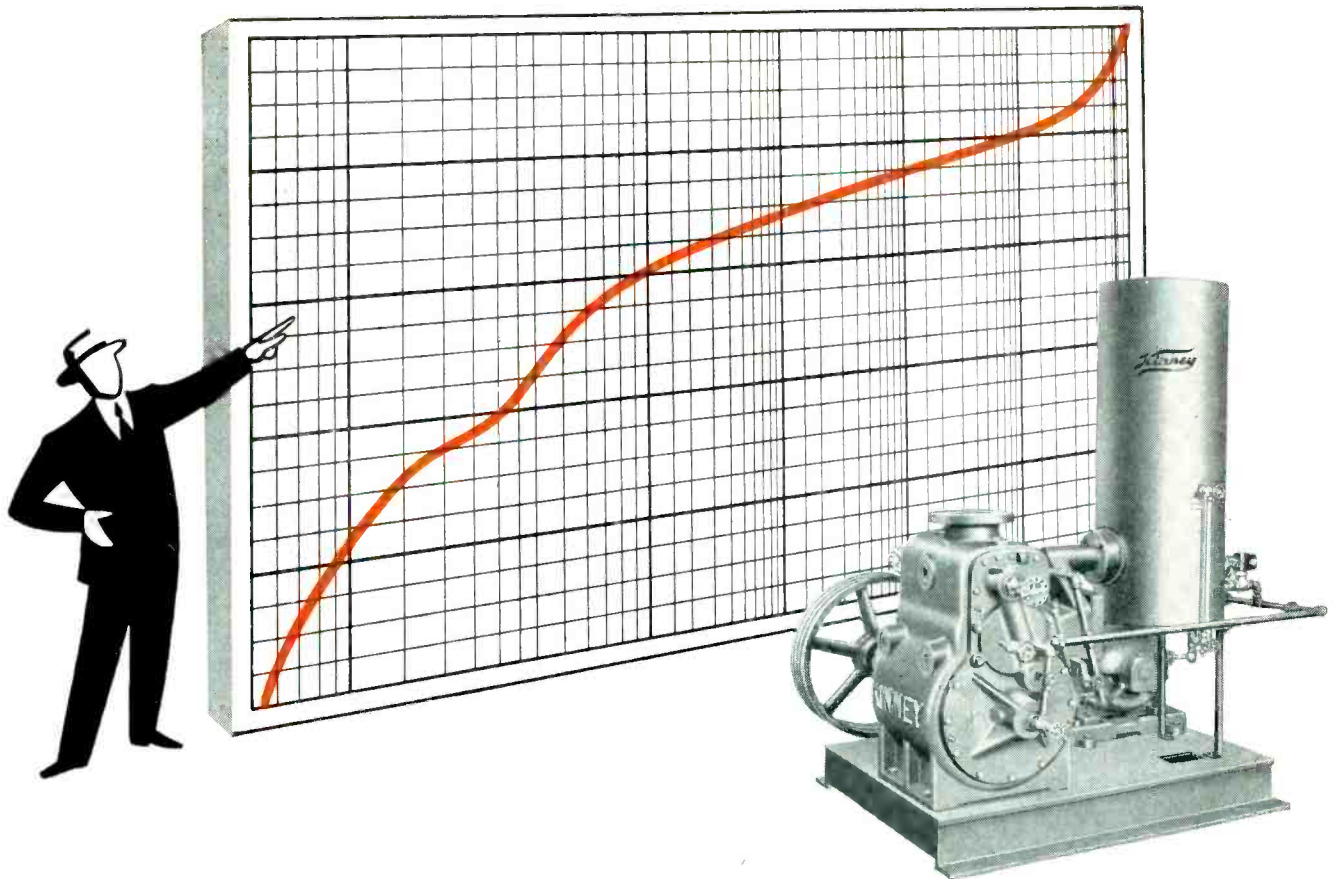

## HERE'S VACUUM PERFORMANCE!

In vacuum processing *performance* counts — and no pump can give you better performance than a Kinney Vacuum Pump. High pumping speeds, efficient use of power, extremely low ultimate pressures, and dependability that's unsurpassed — these are the reasons why you'll find Kinney Vacuum Pumps in such a large percentage of all vacuum processes. Kinney Pumps help to create the low absolute pressures needed to produce light bulbs, electronic tubes, vitamin concentrates, penicillin, malleable titanium, dehydrated foods, costume jewelry, and scores of other up-to-the-minute products. Whether your problem involves laboratory, pilot plant, or full scale

production, it will pay you to get Kinney Vacuum Pumps. Kinney engineers will gladly show you performance records of Kinney Pumps on jobs like your own. Send coupon for complete details today! KINNEY MANUFACTURING COMPANY, Boston 30, Mass. Representatives in New York, Chicago, Cleveland, Houston, New Orleans, Philadelphia, Los Angeles, San Francisco, Seattle.

**FOREIGN REPRESENTATIVES:** General Engineering Co. (Radcliffe) Ltd., Station Works, Bury Road, Radcliffe, Lancashire, England . . . Horrocks, Roxburgh Pty., Ltd., Melbourne, C. I. Australia . . . W. S. Thomas & Taylor Pty., Ltd., Johannesburg, Union of South Africa . . . Novelectric, Ltd., Zurich, Switzerland . . . C.I.R.E., Piazza Cavour 25, Rome, Italy.



### SEND COUPON TODAY

KINNEY MANUFACTURING CO.  
3565 WASHINGTON ST., BOSTON 30, MASS.

Gentlemen:

Please send illustrated Bulletin V45. We are interested in:

- |   |  |
|---|--|
| <input type="checkbox"/> Vacuum exhausting  | <input type="checkbox"/> Vacuum distillation |
| <input type="checkbox"/> Vacuum coating     | <input type="checkbox"/> Vacuum metallurgy   |
| <input type="checkbox"/> Vacuum dehydration |  |

Name..... Company.....  
Address.....  
City..... State.....



# "FOR PERMEABILITY

a core made of **CARBONYL IRON  
POWDER** means compact size  
and efficient performance . . . . ."

"Permeability plus stability—these two qualities determine the ability of a radio receiving set to select and hold clear reception on a particular wave band. In household, portable and automotive receivers, compact size and weight reduction also become important factors . . . . . In the making of both RF and IF coils we have come to rely upon cores made of Carbonyl Iron Powders. We can trust their uniform quality and uniform crystal structure to hold the permeability within plus or minus 1% over a period of years."

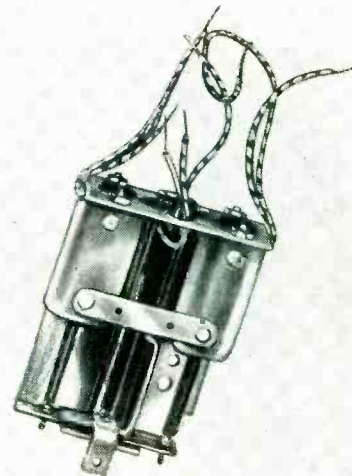

## THE F. W. SICKLES COMPANY

CHICOPEE, MASSACHUSETTS

**FOUNDED IN 1921**—under the name of Radio Development Co.,—the F. W. Sickles Company are today the world's largest makers of radio coils. Several hundred different models of RF and IF coils—made by this firm—are now in daily use by manufacturers of electronic equipment, as well as by amateurs, experimenters, radio service men and government agencies, both here and abroad.

The Sickles endorsement of Carbonyl Iron Powders is extremely grati-

fying to us . . . It is also important evidence for the consideration of any receiver or equipment manufacturer. Let us send you the book described at the right. It will cost you nothing to get the facts . . . Ask your core maker, your coil winder, your industrial designer, how G A & F Carbonyl Iron Powders can improve the performance or reduce the size of the equipment you make. The possible gains and savings are far greater than here indicated.

# G A & F Carbonyl

# TUNING...

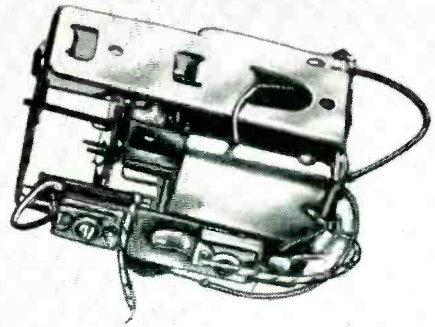
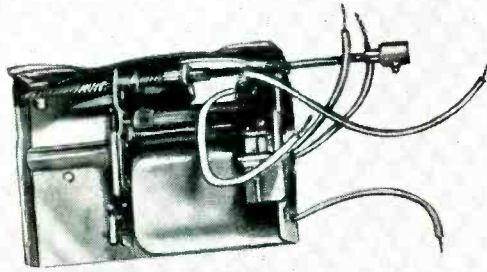

Precision tuning units—made by The F. W. Sickles Company—for broadcast radio receivers

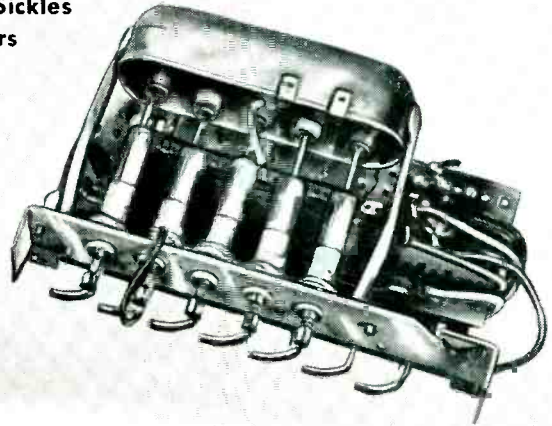
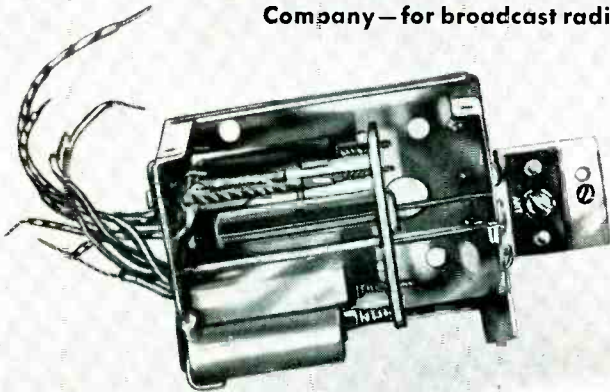

**THIS FREE BOOK** — fully illustrated, with performance charts and application data — will help any radio engineer or electronics manufacturer to step up quality, while saving real money. Kindly address your request to Department 34.



## **ANTARA® PRODUCTS**

DIVISION OF

## **GENERAL DYESTUFF CORPORATION**

435 HUDSON STREET • NEW YORK 14, NEW YORK

# Iron Powders...





# A RAULAND EXCLUSIVE!

*New*  
**"Tilted-Offset" Gun**  
WITH  
**INDICATOR  
ION TRAP**



## Solves one production line problem

Rauland's new Electron Gun offers two production line advantages which TV engineers have welcomed—advantages that help shave pennies off production costs and save minutes on production lines.

The superior design of Rauland's new Tilted Offset Gun eliminates one Ion Trap Magnet, cutting use of rare magnet alloy 50%. Yet, it gives better results—bending the electron beam only once and assuring maximum sharpness of focus.

Even more important is the exclusive Indicator Ion Trap which this gun features. In a matter of seconds—without even seeing the front of the picture tube—the single Ion Trap magnet is adjusted with absolute accuracy.

The magnet is simply moved until a vivid green glow on the anode tube is reduced to minimum. There is no need whatever for any equipment—any skill—any trained judgment. Actually, adjustment is made faster than test equipment could be attached.

To get the benefits that only Rauland offers, specify Rauland tubes with these exclusive advantages. For further information, write to . . .

## **RAULAND**

The first to introduce commercially these popular features:

Tilted Offset Gun

Indicator Ion Trap

Luxide (Black) Screen

Reflection-Proof Screen

Aluminized Tube

Visit us in Booth 334—IRE Show

## THE RAULAND CORPORATION



*Perfection Through Research*

4245 N. KNOX AVENUE • CHICAGO 41, ILLINOIS



VHF  
UHF

# IMPEDANCE MEASUREMENTS

SPEED AND CONVENIENCE

## FTL-42A IMPEDOMETER

Rapid, accurate measurement of impedance, reflection coefficient and standing wave ratio. Small size, convenient for field use.

50 to 500 Mc.

Can be inserted in various sizes of solid coaxial line or flexible cables.

Make three readings; plot diagram and read off impedance to  $\pm 5\%$ .

\$400.00.

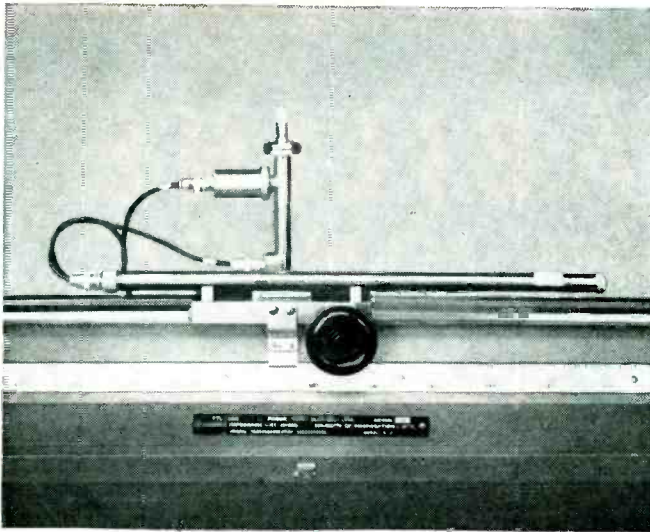

## FTL-30A SLOTTED LINE

Precise impedance measurements in the range of 60 to 1000 megacycles per second. Accuracy  $\pm 2\%$ .

1000 to 2000 Mc range covered with slightly reduced accuracy.

Coaxial line 250 centimeters long having a surge impedance of 51.0 ohms  $\pm 0.5$  ohms.

\$2,495.00.

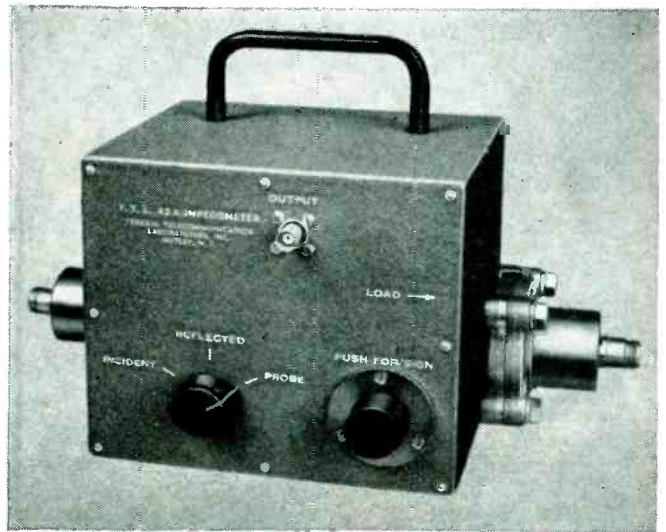

PRECISION

On display at booth 34,  
1951 IRE Radio Engineering Show

Write for FTL-30A and FTL-42A brochures.

**Federal Telecommunication Laboratories, Inc.**

500 Washington Avenue  
Nutley 10, New Jersey





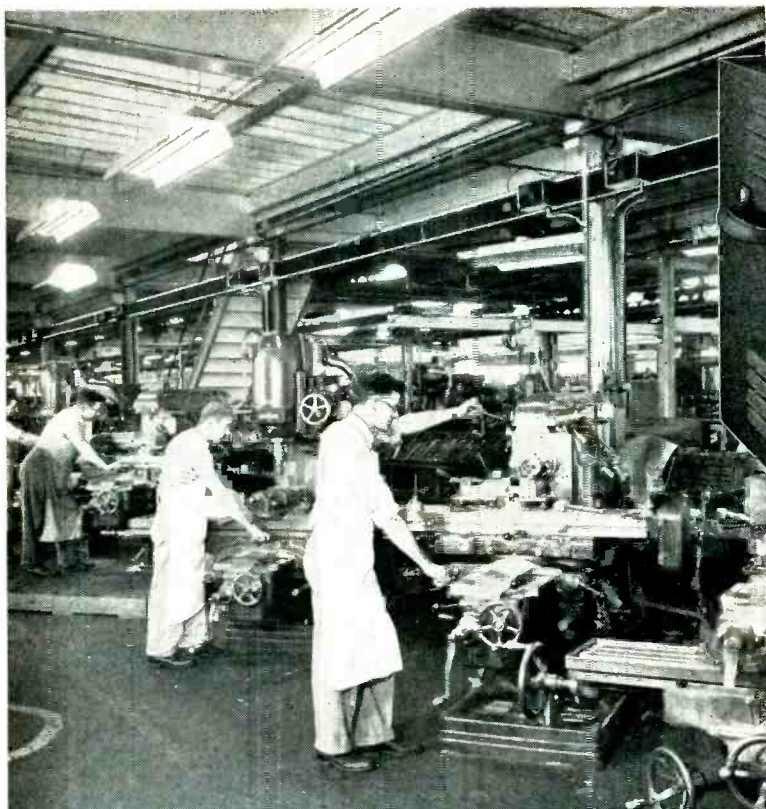

TYPE EM4115

**TYPE EM (Electromechanical)**

Features zero waveform distortion, high efficiency, insensitivity to magnitude and power factor of load, no critical adjustments. Has no effect on system power factor.



# STABILINE

## VOLTAGE REGULATORS

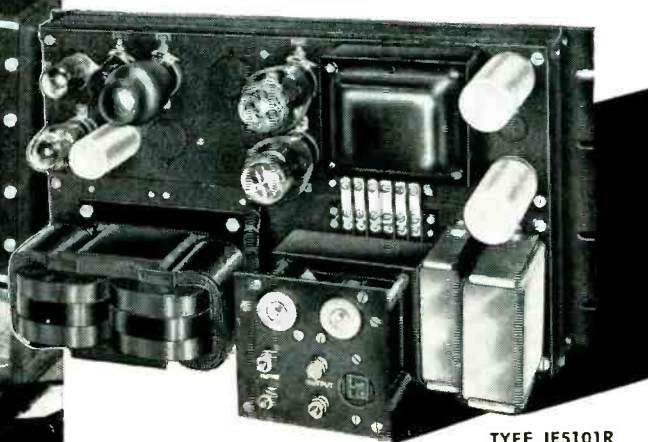

TYPE IE5101R

**TYPE IE (Instantaneous Electronic)**

Completely electronic, instantaneous in action, with no moving parts. Output voltage held to  $\pm .1\%$  for line variations; to  $\pm .15\%$  for load changes



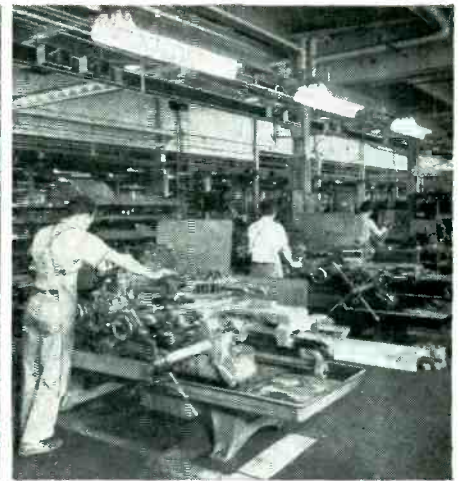

**IN THE LABORATORY**, where constant voltage is a necessity for product development and analysis, STABILINE voltage regulators assure maximum performance of electrical instruments.

**TESTING** requires constant voltage to assure that products manufactured for specific applications will perform as rated. STABILINE voltage regulators guarantee exacting test results.

**PRODUCTION** is on the increase, equipment is working overtime. STABILINE voltage regulators are required to get the maximum from operating equipment, to give full life to motors and lighting, to lengthen tool life, and to cut maintenance and replacement costs.

## MAINTAIN CONSTANT VOLTAGE ...regardless of line or load changes

STABILINE Automatic Voltage Regulators deliver a constant output voltage regardless of variations in input voltage or load current. This control is vital to laboratories, production, testing and inspection — all departments where precision performance is demanded. Two basic types of STABILINES are available. Type IE (Instantaneous Electronic) is completely electronic, instantaneous in action, with no moving parts. Waveform distortion does not exceed 3%. Output voltage is held to within  $\pm 0.1$  of 1% for wide line variations; to within  $\pm 0.15$  of 1% for any load current change or power factor change from lagging .5 to leading .9. Type EM (Electromechanical) consists of an electronic detector circuit controlling a motor-driven POWERSTAT variable transformer which feeds a buck-boost auxiliary transformer. Inherent characteristics include zero waveform distortion, insensitivity to magnitude and power factor of load, adjustable output voltage, no effect on system power factor and no critical adjustments. Both types are offered in numerous models and ratings. There's a STABILINE for every application. Technical data and bulletins sent on request. Use coupon below.

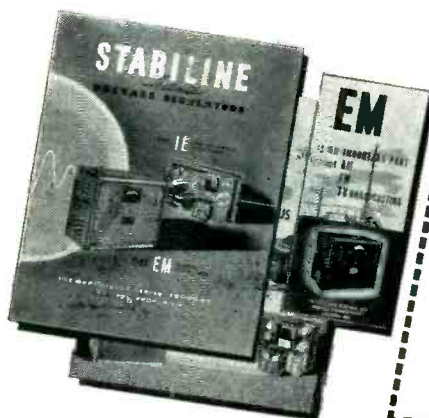

**THE SUPERIOR ELECTRIC CO.**  
BRISTOL, CONNECTICUT



THE SUPERIOR ELECTRIC CO., 403 CHURCH STREET, BRISTOL, CONNECTICUT

- Please send me Bulletin S351 on STABILINE Automatic Voltage Regulators.
- Keep me on your mailing list.
- Have a SECO field engineer call.

My Name \_\_\_\_\_

Company Name \_\_\_\_\_

Company Address \_\_\_\_\_

City \_\_\_\_\_ Zone \_\_\_\_\_ State \_\_\_\_\_





Official U. S. Coast Guard Photo

## risky *business . . .*

**P**oking into uncharted inlets or up fog-shrouded channels is risky business at best, but it's been made a lot less hazardous with the new Edo-designed Contour Bottom Scanner. Known as the CBS and developed for the United States Navy, this electronic device tells the skipper not only the depth of the water below him but on both sides — gives him an actual picture of the channel's contour on a cathode ray tube, shows him where the deepest water is.

Edo has come to be recognized as a leader in the development of depth-finding equipment, such as the CBS, with which to find out more easily and clearly what's below. Edo-developed sonar devices have already made possible new accuracy in under-water detection techniques of vital importance to our Nation's defense.

### OUR TWENTY SIXTH YEAR

The Edo Corporation has been engaged in design and manufacturing work for the past quarter of a century. The company is eminently staffed to undertake research and development of electronic equipment and has a plant adequately equipped to undertake quantity manufacture of intricate electronic devices.

The company's extensive background in the marine and aviation fields makes it particularly well qualified to design and manufacture electronic devices for use in aircraft or on board ship, where features of compactness and rugged design are so necessary.

You'll be interested in our booklet describing Edo's first quarter of a century of progress. Write to Department M-3, Edo Corporation, College Point, L. I., N. Y. for your copy today.



EDO CORPORATION · COLLEGE POINT, N. Y.

---

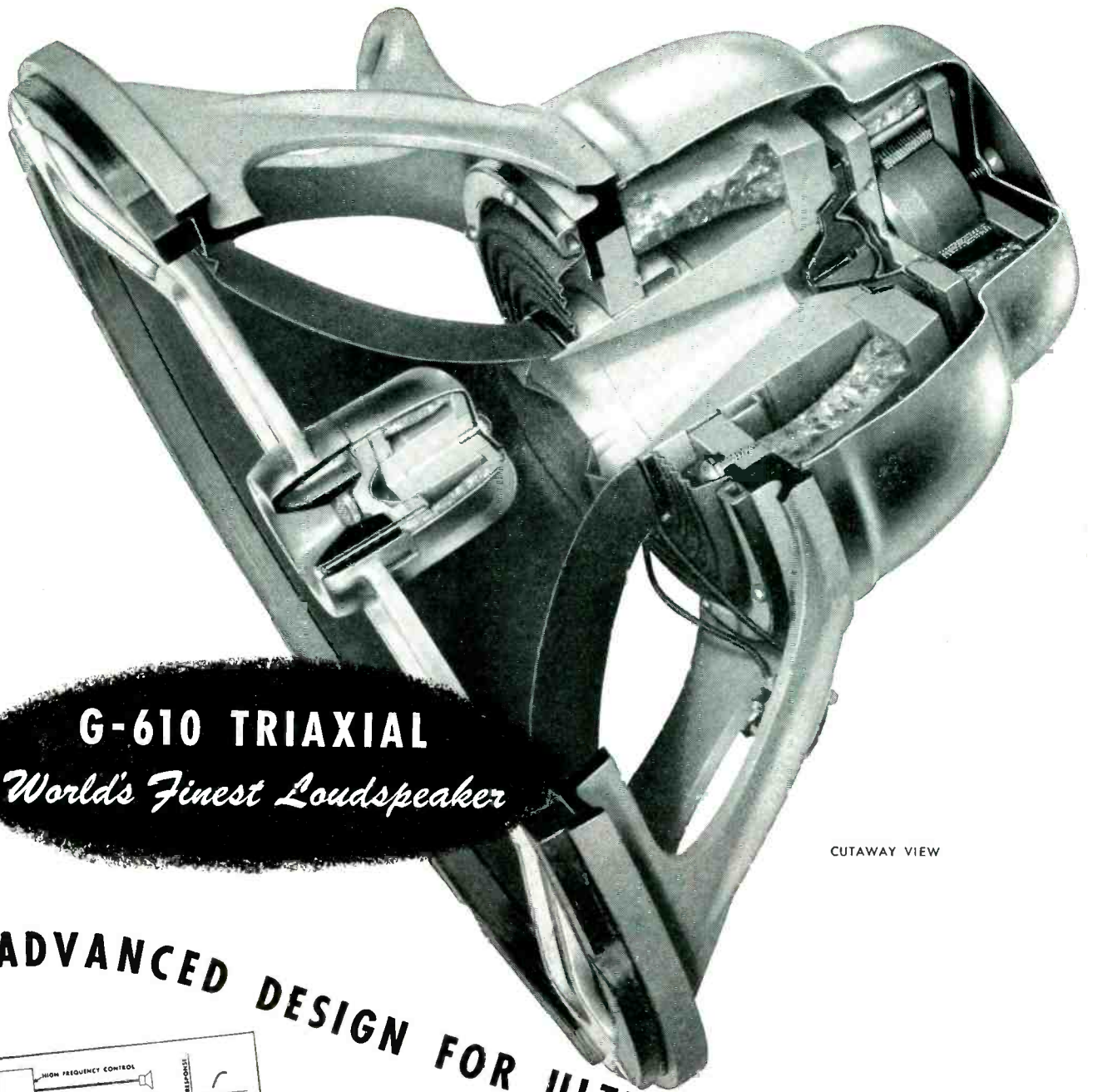

CUTAWAY VIEW

**G-610 TRIAXIAL**  
*World's Finest Loudspeaker*

**ADVANCED DESIGN FOR ULTRA HIGH FIDELITY**

The Jensen G-610 is designed to achieve the highest possible quality of sound reproduction, and yet be a compact unitary assembly. This 3-channel system in one package has the widest frequency range and the lowest distortion available today. Typical of the advanced know-how in acoustics represented here are such features as very low crossover plus compactness, due to articulation of mid-channel horn with low-frequency diaphragm . . . the unique precision compression driver unit . . . built-in ruggedness and reliability combined with precision construction throughout. Write for data sheet 160.

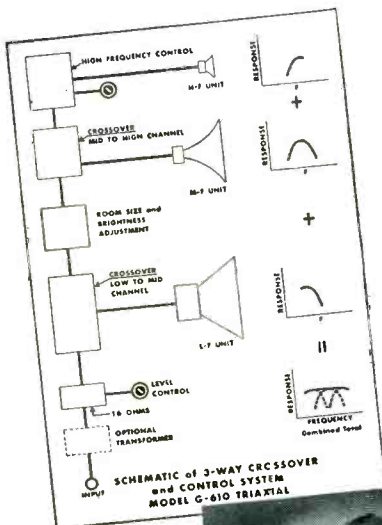

Crossover and Control Network is a separate chassis unit, with plug-in connections for speaker and impedance-adjusting transformer (if needed).

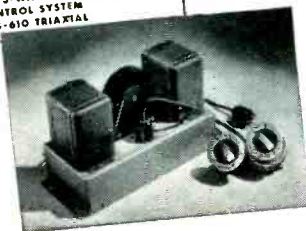

**Jensen** MANUFACTURING COMPANY  
 DIVISION OF THE MUTER COMPANY

6601 SOUTH LARAMIE AVENUE • CHICAGO 38, ILLINOIS



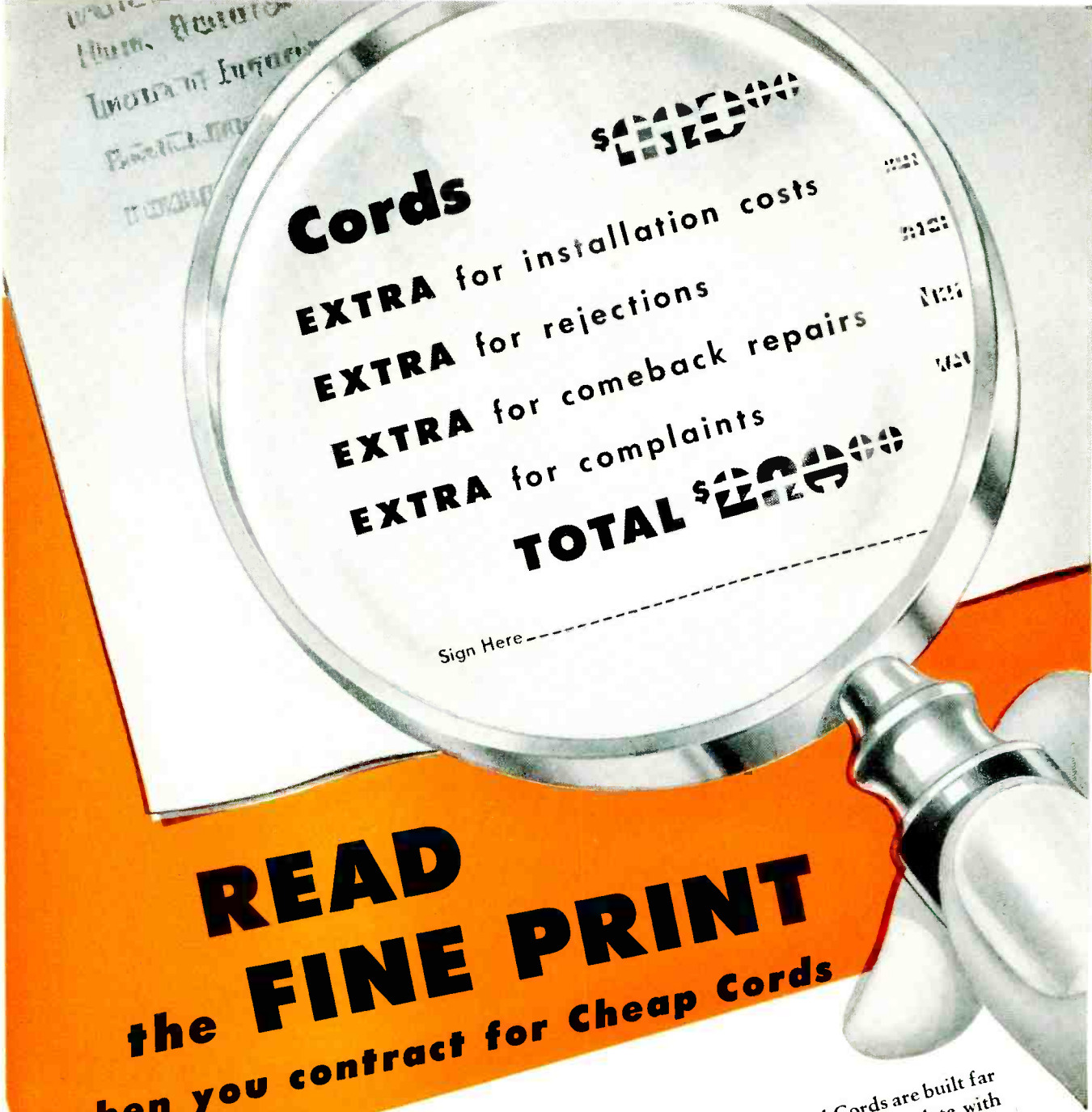

# Cords

**EXTRA** for installation costs

**EXTRA** for rejections

**EXTRA** for comeback repairs

**EXTRA** for complaints

**TOTAL \$22.50**

Sign Here-----

## READ the FINE PRINT

...when you contract for Cheap Cords

With Belden Engineered Cords, there are no hidden costs. Engineered to your product, Belden Cords make for easy installation — eliminate costly extra assembly operations. Engineered for the service they encounter, Belden Cords give your product the chance to operate without cord failure and to maintain your customers' good

will. Belden Engineered Cords are built far above minimum standards, complete with molded plugs, strain reliefs, or connectors, ready to attach. There are no extra costs. Investigate Belden Cords, today. Write Belden Manufacturing Company  
4625 W. Van Buren Street  
Chicago 44, Illinois

CORDITIS-FREE  
CORDS BY . . .

# Belden

**WIREMAKER  
FOR INDUSTRY**

It's

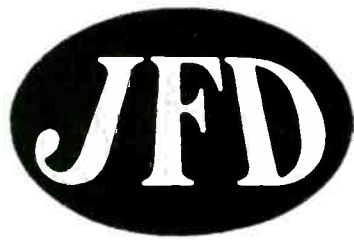

for

# FFD

## Facilities For Defense

JFD . . . one of the world's largest producers of television antennas and accessories . . . invites orders for prime and sub-contract work. Our **Facilities For Defense** have been used, in the past, by such industry leaders as RCA, PHILCO, ADMIRAL, PILOT, MOTOROLA, BENDIX, STROMBERG-CARLSON and many others. Personnel and production machinery are geared to the standard of quality and mass production that meets your "dead-lines" and lowers your costs.

# Can we serve YOU?

We will be  
exhibiting at  
the I.R.E. Show.  
See us in  
Booth No. 215.

For experience, know-how, dependability and financial responsibility—you can count on **JFD's Facilities For Defense**. Phone, wire or write direct to Mr. Albert Finkel, Vice-President.

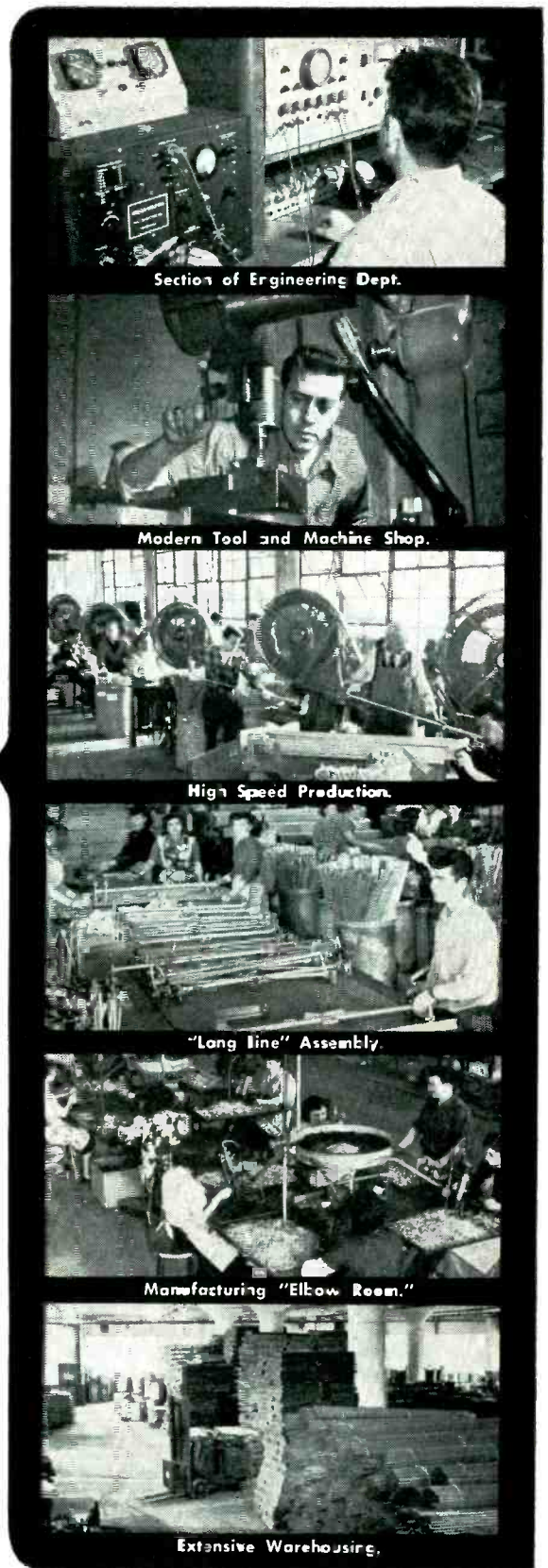

Section of Engineering Dept.

Modern Tool and Machine Shop.

High Speed Production.

"Long line" Assembly.

Manufacturing "Elbow Room."

Extensive Warehousing.

DIVISION OF CONTRACT OPERATIONS



**MANUFACTURING CO., Inc.**  
6145C 16th AVENUE, BROOKLYN 4, N. Y.  
FIRST in Television Antennas and Accessories



# to control high frequencies

## USE LOW-CAPACITANCE RELAYS...

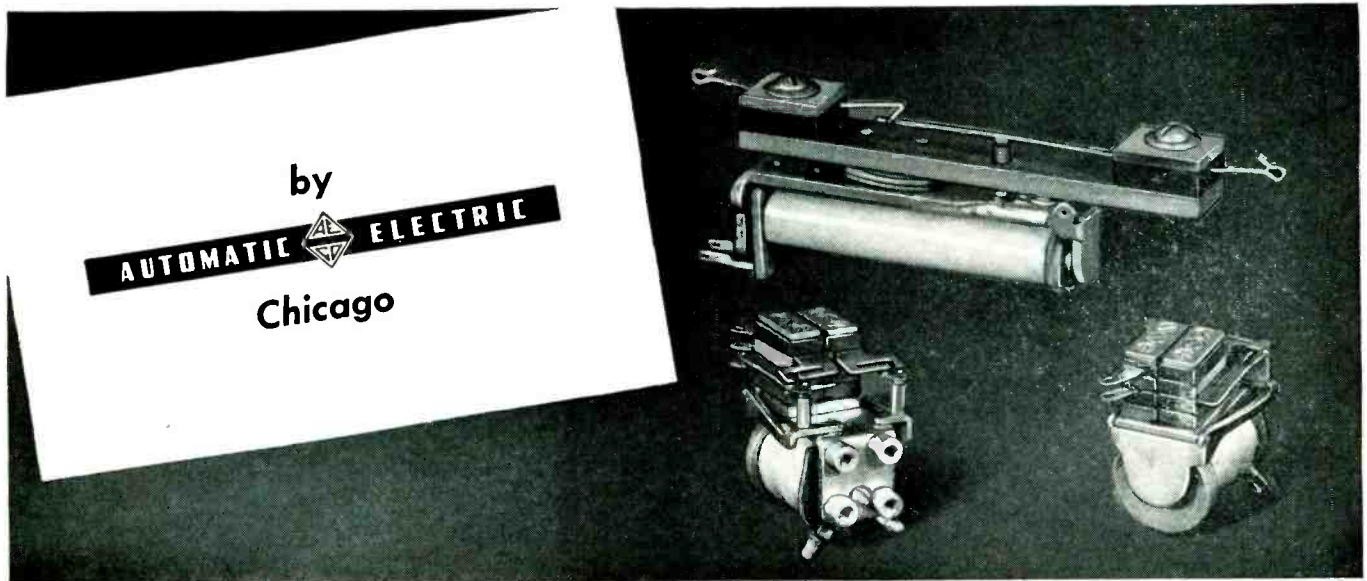

**For smooth, chatter-free control of microwave circuits...** switch them with Automatic Electric relays. Automatic Electric made its first low-capacitance relay more than ten years ago, and today offers two types, each providing exceptionally low capacitance between contact springs, and between springs and ground (frame, mounting, etc.)

In addition to these low-capacitance characteristics, Automatic Electric relays provide the dependability of "twin" contacts and the small size you need for compact mounting. The Class "C" relay (background above) is especially suitable for strip mounting; it is only 0.687" wide and 2 $\frac{1}{8}$ " high and is 5 $\frac{1}{32}$ " in over-all length. The Class "S" relay (two views in foreground) is 1" wide, 1 $\frac{3}{8}$ " high and 1 $\frac{9}{32}$ " long, over-all. Operating mechanisms are basically standard Automatic Electric designs, thus assuring the high operating efficiency for which Automatic Electric controls are famous,

To receive complete information, simply let us know your specific needs. Address AUTOMATIC ELECTRIC SALES CORPORATION, Chicago 7, Ill. In Canada: Automatic Electric (Canada) Ltd., Toronto. *Offices in Principal Cities.*

**RELAYS** **SWITCHES**  
**AUTOMATIC**  **ELECTRIC**  
**CHICAGO**

### OTHER AUTOMATIC ELECTRIC TELEPHONE-TYPE CONTROLS



**Stepping Switches**



**Relays**



**Turn Keys**



**Lever Keys**

Efficient, dependable Automatic Electric controls are available also for many other uses. Lever, turn and push-type keys; telephone-type dials; stepping switches; lamp jacks and caps—as well as a complete range of telephone-type relays carrying the Automatic Electric name—are now in service in hundreds of industrial applications.

**BROWN  
INSTRUMENTS  
ACCELERATE  
RESEARCH**

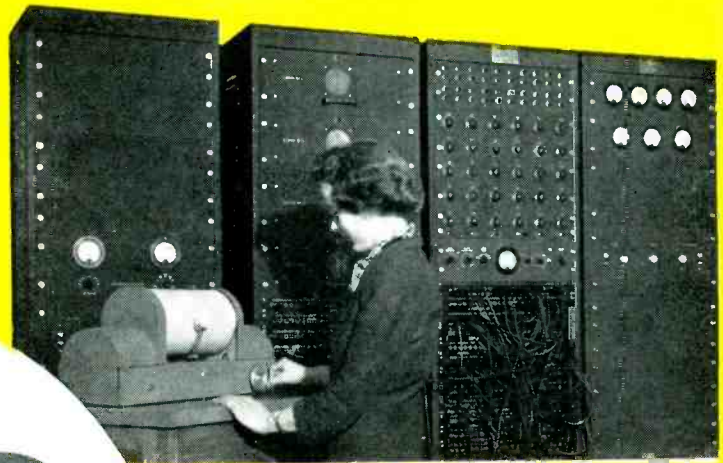

*The REAC Computer is a product of Reeves Instrument Corporation*

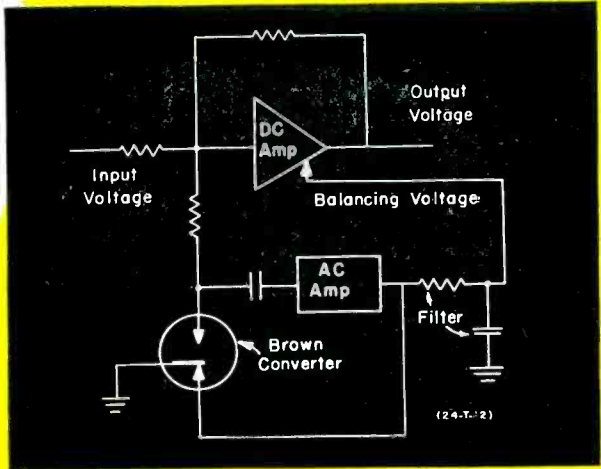

## **BROWN CONVERTER meets critical requirements of REAC COMPUTERS**

**B**ROWN CONVERTERS are precision, vibrator-type converters for use with any system requiring the conversion of low power direct voltage signals of the order of 100 microvolts to 60 or 400 cycle alternating voltages. Typical of its host of applications is in the REAC Computer, produced by the Reeves Instrument Corp. of New York. Here, it meets the requirements for a converter with extremely stable contact characteristics. In the system shown, the converter alternately connects an a-c amplifier to ground and to the d-c amplifier. Any unbalance voltage existing at the input is chopped into a 60-cycle square wave and amplified. The a-c output

is then rectified by the same converter and filtered. The resultant d-c voltage is coupled into the d-c computing amplifier in such a way as to change the output voltage so as to drive the input voltage back to zero. Thus, a slight positive voltage at the input causes a drop in output voltage and oppositely for a negative voltage. This combination affords a system not susceptible to drift. Data Sheet 10.20-1 gives complete details on the converter. Write for a copy. MINNEAPOLIS-HONEYWELL REGULATOR Co., 4428 Wayne Ave., Phila. 44, Pa. Offices in more than 80 principal cities of the United States, Canada and throughout the world.

**MINNEAPOLIS  
Honeywell**

**BROWN INSTRUMENTS**





**IN THE AIR**



**ON THE SEA**



**YES, AND EVEN UNDER THE SEA**

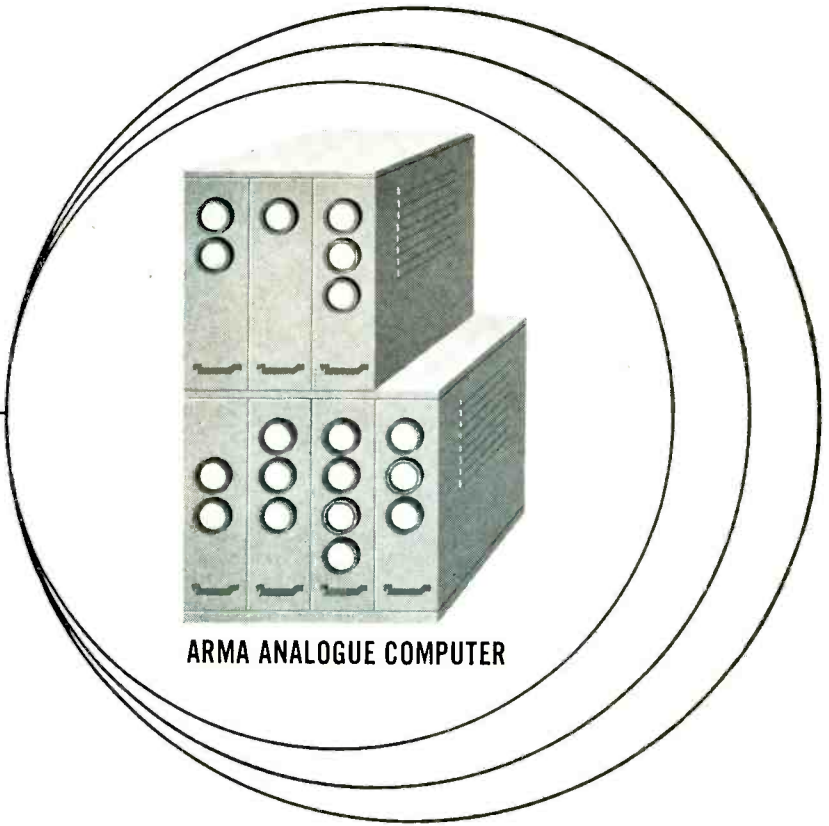

The *Analogue Computer* has long held a high place in Arma's work in such specialized fields as automatic gun-laying and torpedo-data computing for the U.S. Navy. Its present wider application to the needs of the other Services stems largely from accelerated post-war engineering at Arma, which resulted in miniaturizing its components and at the same time making them interchangeable and more accurate.

By this Arma development, the *Analogue Computer* has reached a new level of importance as a contributing factor in the high accuracy of American arms. It is typical of many things developed by Arma engineers to aid in making America safe against those who wish to destroy it.

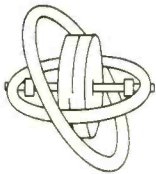

QUALITY **ARMA** PRECISION  
INSTRUMENT

**A R M A C O R P O R A T I O N**

254 36th STREET, BROOKLYN 32, N. Y.

**SUBSIDIARY OF AMERICAN BOSCH CORPORATION**

**PRINCIPAL PRODUCTS**

Gyroscopic Compasses • Gunfire Control Systems • Stabilizing Devices • Automatic Control Switchboards • Electrical & Electronic Equip.  
Electrical Computers • Airborne Instrumentation • Navigational & Plotting Instruments • Mechanical Computers • Servo Mechanisms

# DESIGNER'S

# DILEMMA

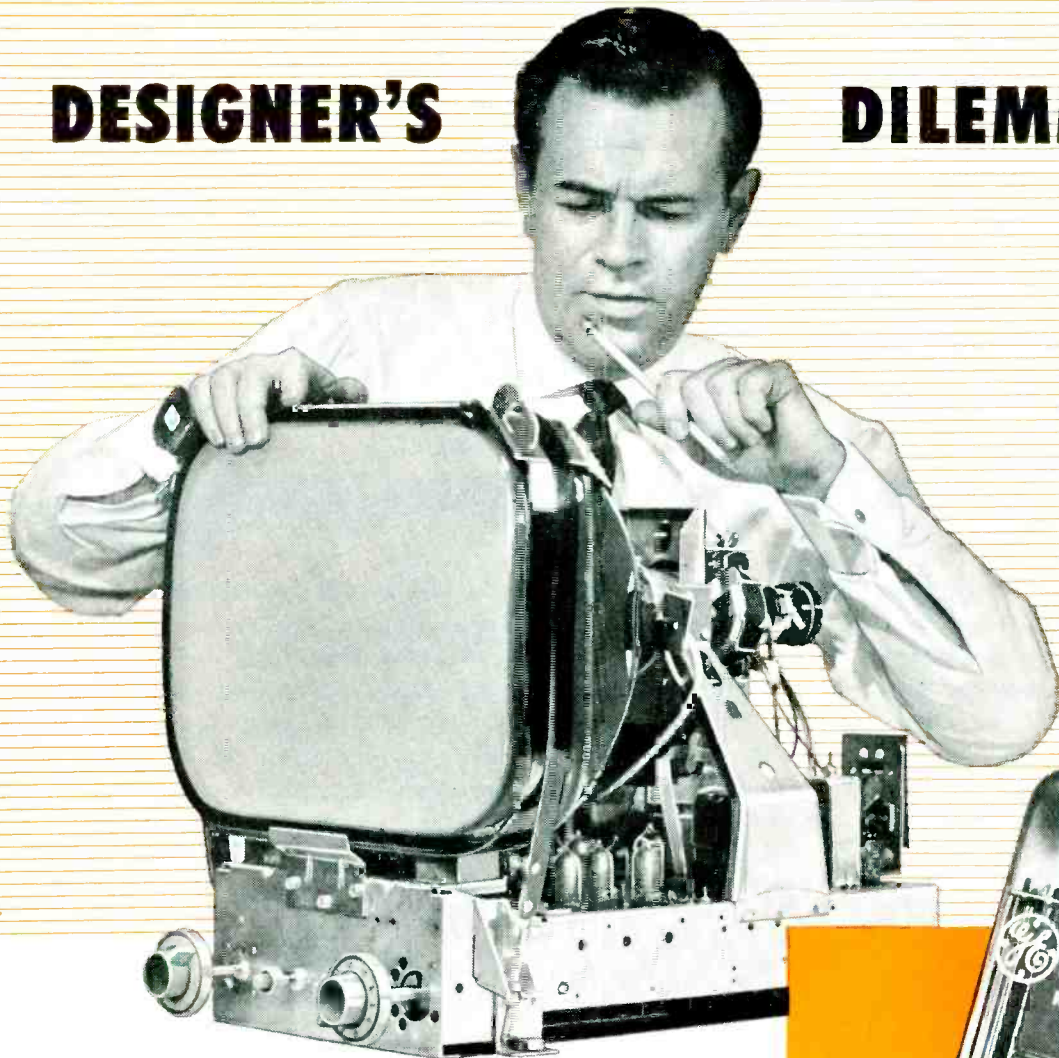

**"How can I save, in order to trim the price of this set another \$2.50?"**

**T**HE answer, Mr. TV-set Designer, is simple: G.E.'s 6BN6 gated-beam tube. It replaces three tubes and associated components, serving as a combined limiter, discriminator, and audio-amplifier.

6BN6 cost is right in line with other receiving types. You get three tubes' performance, yet you pay for only one

Ask for Bulletin ET-B28, which tells the full story of this amazing G-E *economy* tube, also charts its performance. Or if you prefer to discuss the 6BN6 in person, an experienced G-E tube engineer gladly will call on you. Wire or write *Electronics Department, General Electric Company, Schenectady 5, New York.*



## 6BN6

### GATED-BEAM MINIATURE

Typical Operating Conditions,  
TV Application, 4.5 mc

Plate supply voltage	270 v
Plate load resistance	.33 megohms
Accelerator voltage	100 v
Cathode resistance	200 to 400 ohms
Min signal voltage for limiting action	1.25 v RMS
Audio output voltage	12.5 v RMS
AM rejection, with 2-v input signal	25 dB

# GENERAL ELECTRIC

101-K1



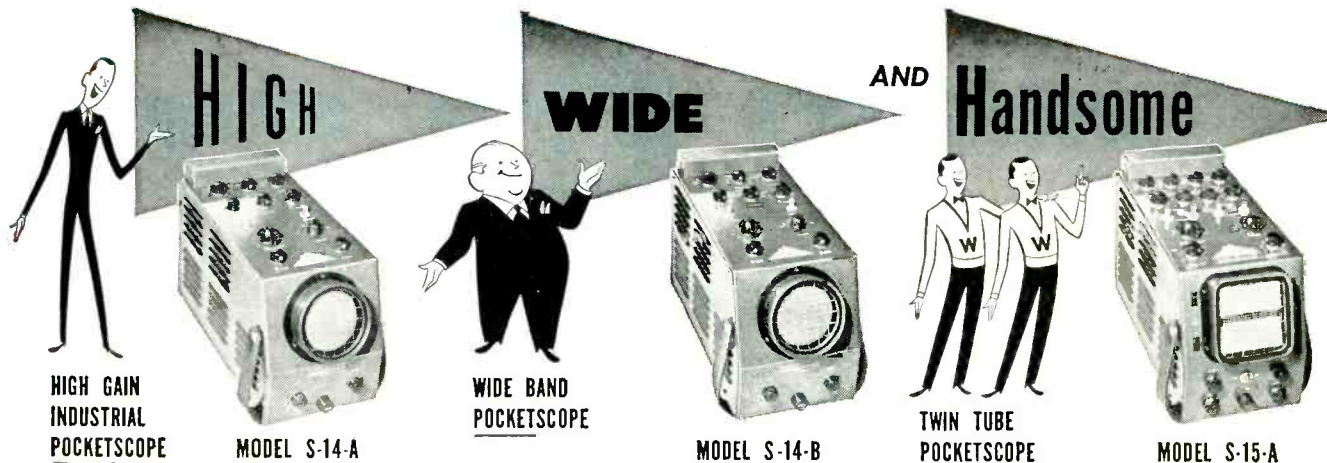

**THE WATERMAN LINE-UP**

**HI, WIDE and HANDSOME POKETSCOPES** are characterized by small size, light weight, and outstanding electrical performance. All units have frequency compensated attenuators as well as non-frequency discriminating gain controls. All units have both periodic and trigger sweeps from 1/2 cycle to 50KC. The amplifiers are direct coupled thus frequency response starts from 0 cycles. No peaking coils are used, thus, the transient response is good. Full expansion of trace, both vertical and horizontal, is built in.

Combination filter and graph screens are used for better visibility, thus traces can be observed even under high ambient light condition. Binding posts for convenience of connections, with effective shield, are used. S-14-A has sensitivity of 10 mv/inch with pass band above 200KC. S-14-B has sensitivity of 50 mv/inch with pass band above 1 megacycle. S-15-A is similar to S-14-A except that it has two independent CR Tubes for multi-trace oscilloscope work. Accessories such as carrying cases and probes are available.

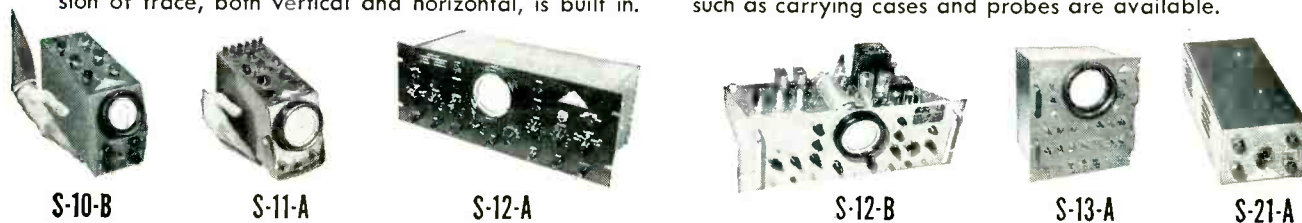

**POKETSCOPES** and **RAKSCOPES** have achieved a reputation for dependability and accuracy. The **LINEAR TIME BASE** can be used with the S-11-A POKETSCOPE or with any other oscilloscope to convert the scope to trigger operation from 1/2 cycle per second.



3SP

**WATERMAN RAYONIC TUBE DEVELOPMENTS**

Since the introduction of Waterman RAYONIC 3MP1 tube for miniaturized oscilloscopes, Waterman has developed a rectangular tube for multi-trace oscilloscopy. Identified as the Waterman RAYONIC 3SP, it is available in P1, P2, P7 and P11 screen phosphors. The face of the tube is 1 1/2" x 3" and the over-all length is 9 1/4". Its unique design permits two 3SP tubes to occupy the same space as a single 3" round tube, a feature which is utilized in the S-15-A TWIN-TUBE POKETSCOPE. On a standard 19" relay rack, it is possible to mount up to ten 3SP tubes with sufficient clearances for rack requirements. Photographic means of recording are under development and will be available shortly.



3MP

TYPICAL OPERATION									
TUBE	VOLTS ANODE #2	VOLTS ANODE #1	VOLTS GRID #1	V IN D1, D2	V/IN D3, D4	MAX. VOLT ANODE #2	MAX. VOLT ANODE #1	VOLTS HEATER	CURRENT HEATER
3SP	1000	165 to 310	-28 to -67	73 to 99	52 to 70	2750	1100	6.3	.6 Amp.
	2000	330 to 620	-58 to -135	146 to 198	104 to 140				
3MP	1000	200 to 350	0 to -68	140 to 190	130 to 180	2500	1000	6.3	.6 Amp.
	2000	400 to 700	0 to -126	280 to 380	260 to 360				

**WATERMAN PRODUCTS CO., INC.**

PHILADELPHIA 25 • PENNSYLVANIA • U. S. A.  
 Manufacturers of **POKETSCOPES**® • **RAKSCOPES**® • **PULSESCOPES**® and **RAYONIC TUBES**®

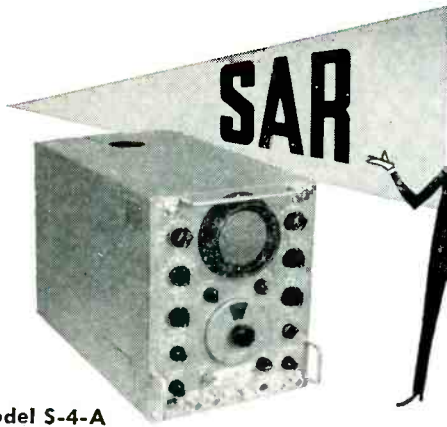

Model S-4-A



and

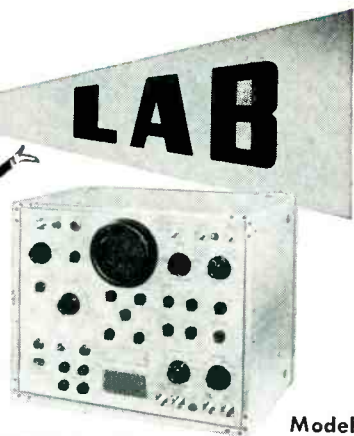

Model S-5-A

**WATERMAN PIONEERING**

# WATERMAN INTRODUCES TWO NEW CATHODE RAY OSCILLOSCOPES

Compact, Portable Instruments For Precision Pulse Measurement Adaptable To All Electronic Work, Including TV . . .

## *The* **PULSESCOPE**

TO PORTRAY THE ATTRIBUTES OF THE PULSE :  
SHAPE, AMPLITUDE, DURATION AND TIME DISPLACEMENT

Video Amplifier up to 11 MC • Video Delay 0.55  $\mu$ s  
Pulse Rise and Fall Time Better Than 0.07  $\mu$ s

### **S-4-A SAR PULSESCOPE**

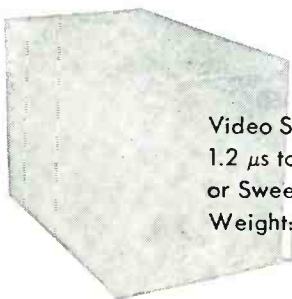

Video Sensitivity 0.5 v p to p/in. • S Sweep 80 cycles to 800kc, either trigger or repetitive • A Sweep 1.2  $\mu$ s to 12,000  $\mu$ s • R Delay 3  $\mu$ s to 10,000  $\mu$ s, directly calibrated on precision dial • R Pedestal or Sweep 2.4  $\mu$ s to 24  $\mu$ s • Internal Crystal Markers 10  $\mu$ s and 50  $\mu$ s • Size: 9 $\frac{1}{8}$  x 11 $\frac{1}{4}$  x 10 $\frac{1}{4}$  • Weight: Less than 32 pounds.

### **S-5-A LAB PULSESCOPE**



Video Sensitivity 0.1 v p to p/in. • Sweep 1.2  $\mu$ s to 120,000  $\mu$ s with 10 to 1 expansion • Sweep either trigger or repetitive • Internal Markers synchronized with sweep from 0.2  $\mu$ s to 500  $\mu$ s • Trigger Generator and built-in precision amplitude calibrator • Completely cased • Size: 16 $\frac{1}{2}$  x 14 $\frac{1}{8}$  x 17 $\frac{1}{2}$  • Weight: Less than 60 pounds.

See these  
two NEW  
**PULSESOPES**  
...at the



CABLE ADDRESS :  
**POKESCOPE, PHILA.**





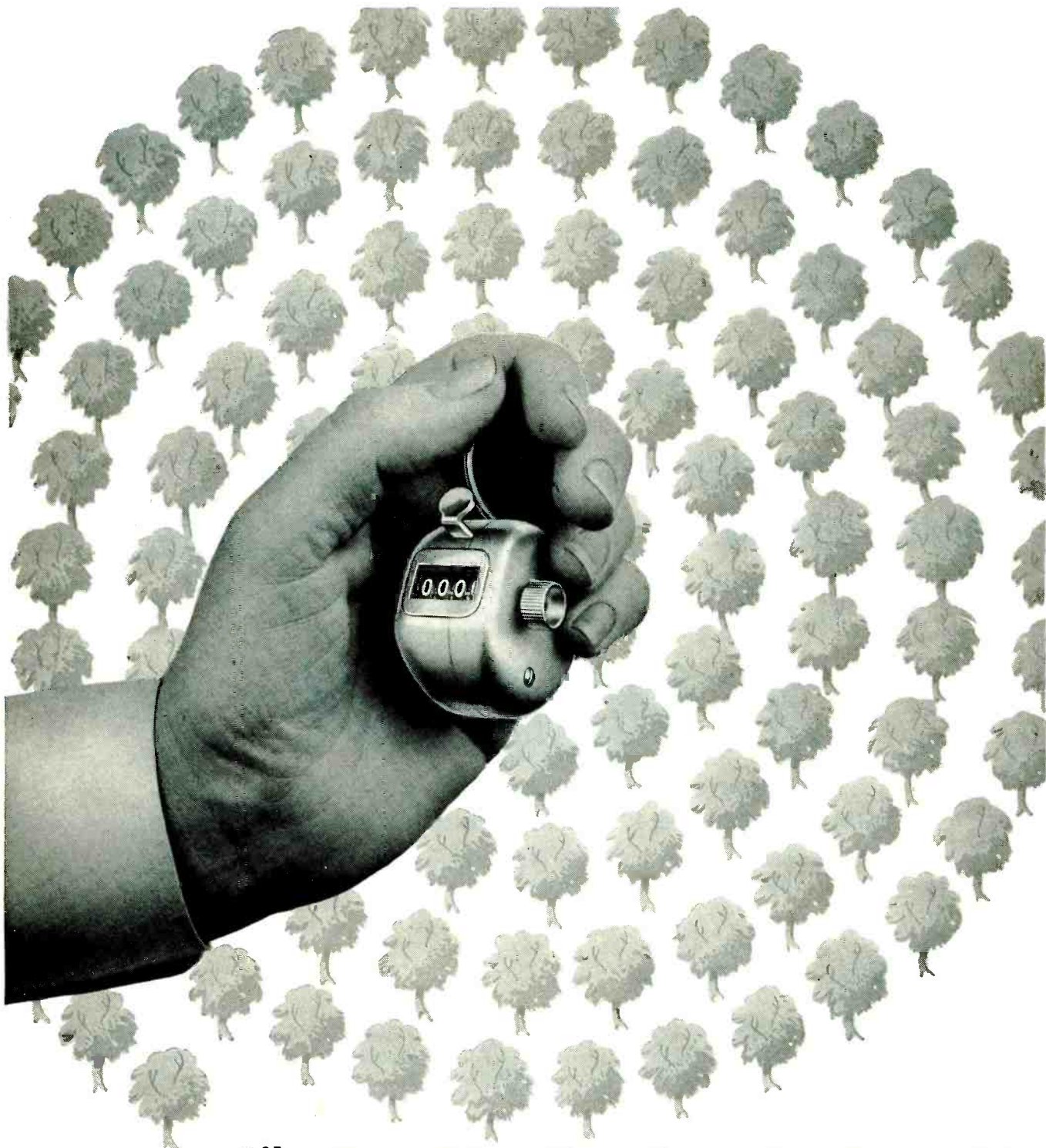

## Like Everything Else, These Are Counted by **VEEDER-ROOT** **COUNTERS**

*Name it and you can count it...trees, cars, people . . . and many other units that are difficult to count in any other way than with a Veeder-Root Hand Tally...on which you simply press the thumb-lever once for each count.*

And in addition, there are many other Veeder-Root Counters which count mechanically and electrically in any terms or

units you want. But if you want to count up to a *real* payoff, then build V-R Counters into your machine or product as original equipment. *How to do it?* Write and find out:

**VEEDER-ROOT INCORPORATED  
HARTFORD 2, CONNECTICUT**

Greenville, S. C. • Montreal, Canada • Dundee, Scotland • Offices and agents in principal cities



Welded

# GERMANIUM DIODES



New G-E diode plant at Clyde, New York

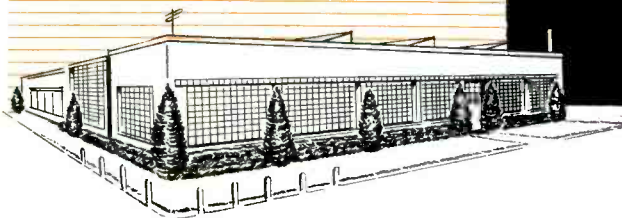

## NEW MANUFACTURING FACILITIES INCREASE PRODUCTION 200%!

**I**N a nutshell, here's what General Electric offers electronic equipment manufacturers:

**Plant Capacity** to help meet total estimated industry and mobilization requirements of germanium diodes and associated products...

**Proved Design** backed by research that is steadily increasing the use of diodes in place of vacuum tubes in many circuits...

**Lower Costs** than any other diode manufacturer offers today...

**Application Engineering Service** that will put G-E diode engineers to work on your circuit problems at your request...

We would like to discuss your requirements. As a start, let us send you Bulletin X57-015 covering the specifications of our diodes. Write to the *General Electric Company, Section 431, Electronics Park, Syracuse, New York.*

### COMPLETE LINE OF GENERAL ELECTRIC WELDED GERMANIUM DIODES

General Purpose		Television	JAN	UHF	Quads	Transistors
1N48	1N63	1N64	1N69	1N72	1N73	SX-4A
1N51	1N75	1N65	1N70		1N74	Z-2
1N52						



*You can put your confidence in—*

# GENERAL ELECTRIC



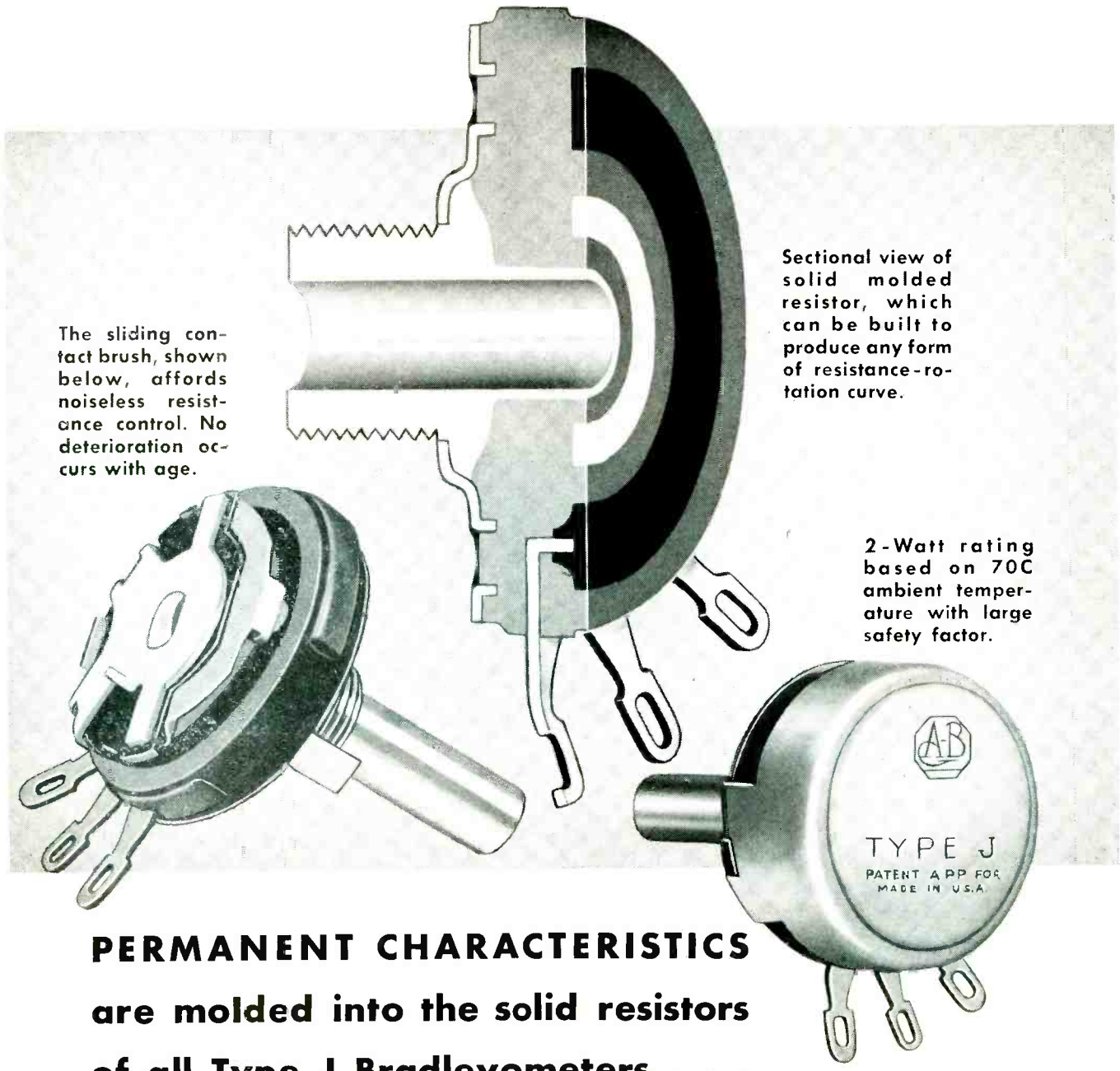

The sliding contact brush, shown below, affords noiseless resistance control. No deterioration occurs with age.

Sectional view of solid molded resistor, which can be built to produce any form of resistance-rotation curve.

2-Watt rating based on 70C ambient temperature with large safety factor.

**PERMANENT CHARACTERISTICS are molded into the solid resistors of all Type J Bradleyometers . . .**

For circuits requiring a top quality adjustable resistor that is not affected by moisture, heat, cold, or age . . . the Allen-Bradley Type J Bradleyometer is the ideal unit.

The resistor element is molded as a single piece. Insulation, terminals, faceplate, and threaded bushing are molded together into a solid, one-piece unit. There are no nuts . . . no welded or soldered connections . . . and the shaft, cover,

faceplate, and other ferrous parts are made of stainless steel.

Available in single, dual, and triple unit construction. Built-in line switch is also available.

Send for dimension sheet and performance curves.

Allen-Bradley Co.  
110 W. Greenfield Ave. Milwaukee 4, Wis.



Bradleyometers are available with any type of shaft extension to fit your requirements.

  
**ALLEN-BRADLEY**  
**FIXED & ADJUSTABLE RADIO RESISTORS**  
 Sold exclusively to manufacturers  **QUALITY**  of radio and electronic equipment

# Our hat is off



## to the Electronic engineers

Engineering is a conservative and modest profession, and rare is the occasion on which electronic engineers are publicly acclaimed. Yet these men are making priceless contributions to industrial progress and national defense.

Since we serve a large number of the country's radio-electronic equipment manufacturers, we have come to know and respect their engineering personnel.

It is, in a large measure, to these men that we are indebted for helping us maintain our reputation as perfectionists in sheet metal fabrication. Their exacting demands and advanced designs keep us ever alert to match their high standards in our own performance.

Gentlemen, we doff our hat in well deserved tribute. Let us shake your hands at Booths 49-50 at the I. R. E. Show.

**KARP METAL PRODUCTS CO., INC.**

215 63rd STREET, BROOKLYN 20, NEW YORK

*Specialists in Fabricating Sheet Metal for Industry*



# CARBOLOY<sup>®</sup> is ready to for Alnico

Production facilities  
available for many

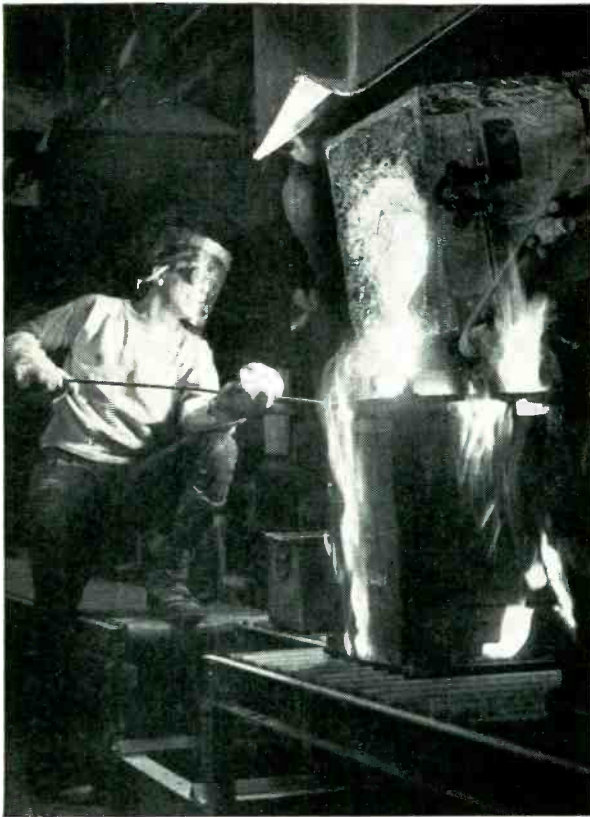

**1** Pouring molten Carboloy Permanent Magnets from electric furnace at 1800°C. Samples of every melt are checked for physical, chemical, and metallurgical qualities before release for fabrication.



**3** Every Carboloy Alnico Permanent Magnet is subjected to countless quality checks like this flux test to assure you of outstanding uniformity and performance.

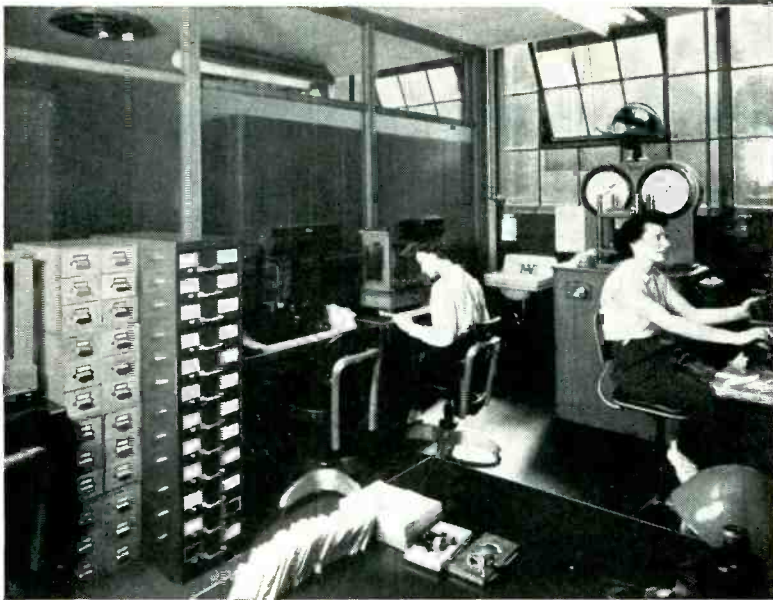

**2** As permanent magnets move from one production step to the next, every batch is quality checked and recorded.

**LOOK TO  
CARBOLOY CO., INC.**

*for the finest  
in versatile metals*

# serve your defense needs permanent magnets

## and expert engineering services essential magnet requirements

4 Carboloy's rigid quality tests pay off in uniform high quality Carboloy Permanent Magnets for peace-time uses like this television tube. You are assured of the same high quality for radar and other defense applications.



**T**HROUGHOUT 1950 Carboloy Company expanded and improved its facilities for the manufacture of permanent magnets (Alnico and other types), and increased its technical organization. Today, Carboloy's extensive production facilities and its engineering consultants and technicians are available to give immediate attention to your orders for many essential magnet requirements.

For over 22 years the name Carboloy has been a synonym for uniformity and outstanding quality with users of cemented carbides. In the present emergency the long-time Carboloy standards of continuous quality control are being applied to assure you of *uniform* Alnico permanent magnets. Write today for information: Special Metals Division, Carboloy Company, Inc., 11139 E. 8 Mile Road, Detroit 32, Michigan.

® The trade-mark "Carboloy" denotes manufacture by Carboloy Company, Inc.

**CARBOLOY**  
THE QUALITY BRAND

**PERMANENT MAGNETS**  
(Alnico and other types)



**IT'S GOOD TO HAVE  
A COST-SAVING ITEM  
UP YOUR SLEEVE!**



AMP Trade-Mark  
Reg. U.S. Patent Off.



U.S. Patent Nos. 2,410,321;  
2,379,567; 2,405,111; 2,468,169

**INTERESTED IN SAVINGS UP TO 65%  
IN MATERIAL AND 90% IN LABOR?\***

These figures are not unusual when wiring efficiency is stepped-up through use of AMP Solderless Terminals! Shown above is the AMP P.I.D.G.†—No tape, solder, flux, or tubing needed. Just slip the terminal over the wire and crimp in one quick operation. Result: A completely insulated vibration-proof connection that will give top performance in the most critical applications.

Hand, foot, pneumatic, or automatic machines are available for production speeds ranging up to 3,300 finished terminations per hour!

\*Actual case studies are available upon request.

†P.I.D.G. stands for AMP PRE-INSULATED DIAMOND GRIP—insulation is already attached.

**Solderless Wiring Devices**  
**AIRCRAFT-MARINE PRODUCTS INC.**  
1611 N. Fourth Street • Harrisburg, Pa.  
Canadian Representative: R. M. Hutcheson, 10 Nordale Crescent  
Hardington, P. O., Toronto 15, Ont., Canada

# OHMITE

**STOCKROOMS ARE PREPARED  
FOR THIS EMERGENCY, TOO!**

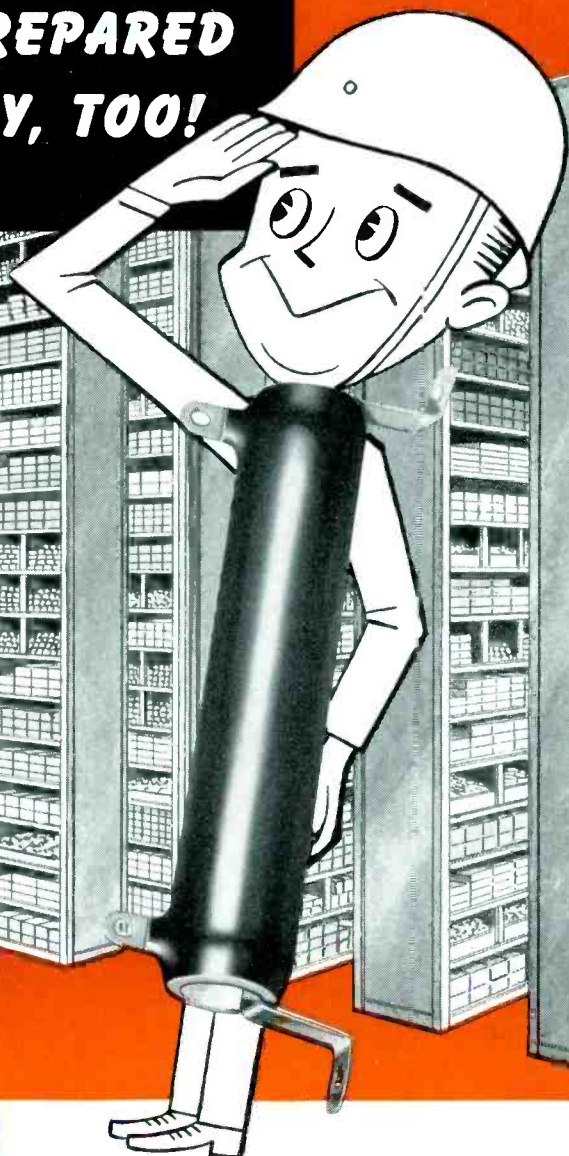

**OHMITE** will continue to  
maintain the world's largest stock  
of **WIRE-WOUND RESISTORS**  
**RHEOSTATS—TAP SWITCHES**

**READY for quick delivery on small orders!**

**OHMITE MFG. CO.**

4817 Flournoy St., Chicago 44, Ill.

During World War II, Ohmite maintained large stocks of standard resistance components, and was able to fill thousands of small emergency orders. Ohmite is ready in this emergency, too — with the world's largest stock of wire-wound resistors, rheostats, and tap switches. On small orders for such standard items, Ohmite is able to give excellent delivery—in spite of current shortages!

*Be Right with* **OHMITE**®

**RHEOSTATS • RESISTORS • TAP SWITCHES • CHOKES • ATTENUATORS**



# Mr. Manufacturer:

To get the best delivery on **OHMITE** resistance components, tailor your needs to these "standard" **OHMITE** items...

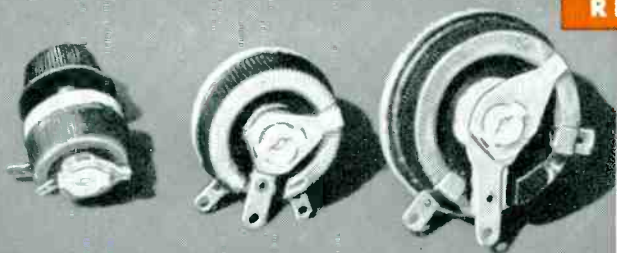

## RHEOSTATS

The Ohmite series of standard, close control rheostats is the most extensive available—so it is easy to select a size to fit your application. There are ten sizes, ranging from 25 to 1000 watts, with many standard resistance values in each size. All models have the Ohmite all-ceramic construction, with winding permanently locked in vitreous enamel, and smoothly gliding metal-graphite brush.



## RESISTORS

The extensive range of Ohmite types and sizes makes possible an almost endless variety of standard resistors to meet your needs. The Ohmite line includes more than 60 core sizes, in a wide range of wattage and resistance values. There are also 18 types of resistor terminals available. Included in the standard Ohmite line are fixed, adjustable, tapped, non-inductive, and precision resistors. Specially developed vitreous enamel provides years of unflinching performance.

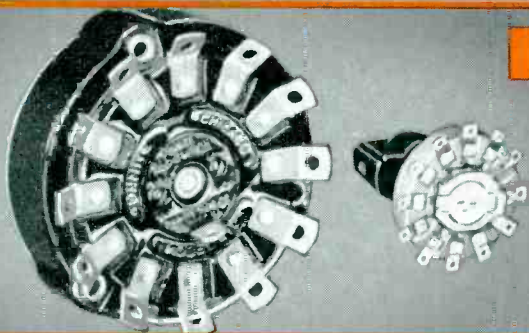

## TAP SWITCHES

Ohmite tap switches are supplied in five standard models, rated at 10, 15, 25, 50, and 100 amperes, a.c. They combine high current capacity and a large number of taps with unusual compactness. Their sturdy, one-piece ceramic bodies provide permanent non-arcing insulation. Their heavy silver-to-silver contacts have a self-cleaning action and provide continuous, dependable contact with low resistance. Ohmite tap switches are supplied in enclosed or open, shorting or non-shorting types.

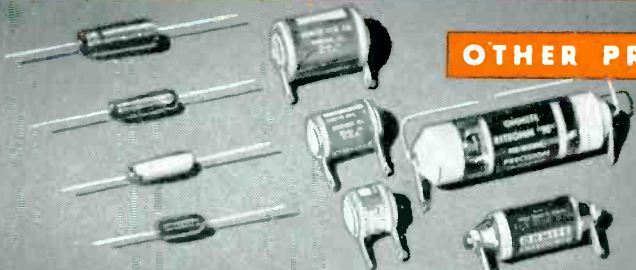

## OTHER PRODUCTS

Ohmite offers an extensive line of standard precision, non-inductive resistors in  $\frac{1}{2}$ - and 1-watt sizes, in the standard type, vitreous-enamelled type, or hermetically sealed in glass. They have an accuracy of  $\pm 1\%$ . Ohmite non-inductive vitreous-enamelled resistors are also available in standard 50-, 100-, and 160-watt sizes in a wide range of resistance values. In addition, Ohmite provides radio-frequency plate chokes, power line chokes, and dummy antennas.



Write ON COMPANY  
LETTERHEAD FOR CATALOG  
AND ENGINEERING  
MANUAL NO. 40

OHMITE MFG. CO.,  
4817 Flournoy St.,  
Chicago 44, Ill.



Be Right with

# OHMITE®

RHEOSTATS • RESISTORS • TAP SWITCHES





*Specify Sorensen*

# AC VOLTAGE REGULATORS

Accuracy, with rugged construction, economical and trouble-free operation, reasonable cost — those are features that you expect, and get, when you specify Sorensen regulators!

- ALL SORENSEN REGULATORS HAVE THESE ADVANTAGES:**
- WIDE INPUT RANGE
  - ADJUSTABLE OUTPUT VOLTAGE THAT STAYS SET
  - REGULATION ACCURACY OF  $\pm 0.1\%$
  - EXCELLENT WAVEFORM
  - FAST RECOVERY TIME
  - INSENSITIVITY TO LINE FREQUENCY FLUCTUATIONS.



**MODEL NO. 500-S**

### STANDARD AC SPECIFICATIONS

VA capacity	150	250	2000	5000
	500	1000	3000	10000 15000
Harmonic Distortion	3% max.	2% max.	3% max.	3% max.
Regulation accuracy	$\pm 0.1\%$ against line or load			
Input voltage	95-130 VAC; also available for 190-260 VAC single phase 50-60 cycles			
Output voltage	Adjustable between 110-120; 220-240 in 230 VAC models			
Load range	0 to full load			
P.F. range	Down to 0.7 P.F. All models temperature compensated			

NOTE: THREE PHASE AND 400 CYCLE REGULATORS ALSO AVAILABLE. ALL REGULATORS CAN BE HERMETICALLY SEALED.

Write for Complete Literature

For regulated DC problems investigate Sorensen's  
line of Voltage Reference Standards,  
DC Supplis, and NOBATRONS



**Sorensen and company, inc.**  
375 FAIRFIELD AVE. • STAMFORD, CONN.

MANUFACTURERS OF AC LINE REGULATORS, 60 AND 400 CYCLES; REGULATED DC POWER SOURCES; ELECTRONIC INVERTERS; VOLTAGE REFERENCE STANDARDS; CUSTOM BUILT TRANSFORMERS; SATURABLE CORE REACTORS

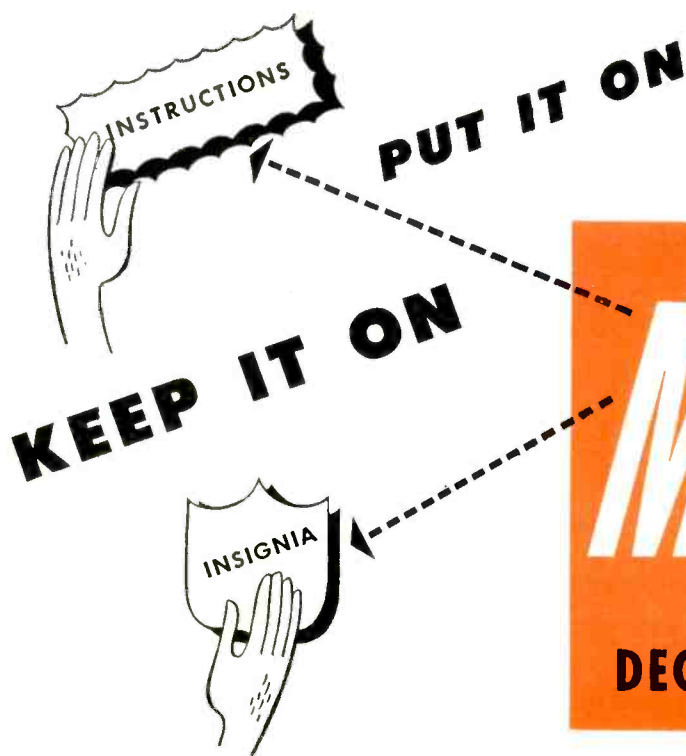

**KEEP IT ON**

**PUT IT ON**

**WITH**

# Metal-Cals\*

**SUPERIOR TO BOTH  
DECALS AND NAMEPLATES**

## SELF-ADHESIVE • PERMANENT

**METAL-CALS** consist of a .003" thickness of aluminum foil anodized and dyed, backed with high-tensile bonding material. A METAL-CAL, with your name or message etched into its surface, can be swiftly applied to any smooth, cohesive surface of metals, porcelain, bakelite, polysterene, glass, woods, paints or enamels. Once on—it stays on, telling your story again and again!

### Only METAL-CALS offer all these advantages:

**ECONOMY**—No holes to drill, no screws, rivets, escutcheon pins or other fastening devices required. Labor, material costs slashed. Long life eliminates replacement cost of decals and litho-plates.

**DURABILITY**—METAL-CALS far surpass in performance the best of decals. They have passed the most rigid weathering, salt spray, humidity, abrasion, low and high temperature tests.

**SIMPLICITY OF APPLICATION**—After removing by water immersion the cellophane film protecting a METAL-CAL's pressure-sensitive adhesive, anyone can apply quickly to smooth, cohesive surfaces.

**LONG LIFE**—Won't chip, peel or crack. Letters, characters and colors are part of the aluminum foil itself . . . stay clear, sharp, easy-to-read.

**COLOR VARIETY**—Choose any one of 5 permanent, attractive colors—yellow, red, blue, black, green—plus aluminum. Available with either dull (matte) or lustrous metallic finish.

**METAL-CALS** have found acceptance and wide use in industries everywhere—wherever there is need for an inexpensive, permanent method of applying trade names, trade marks, insignia, numbers, specifications, diagrams, instructions, dial and gauge markings, operating or maintenance instructions, dealer service nameplates.

### You've tried the rest — Now USE the Best!

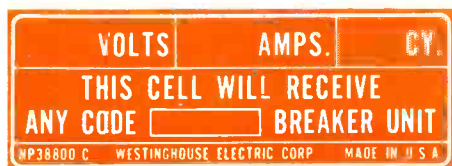
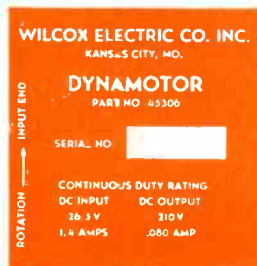
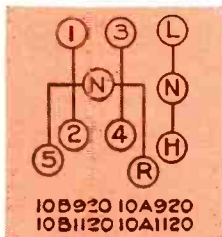

For complete data, samples, technical information, write

**METAL-CAL DIVISION  
C & H Supply Co.**

Dept. A-1 Boeing Field • Seattle 8, Wash.

\* Trade Mark Registered—U. S. and Foreign Patents Pending



improve your product with -

# MYCALEX

THE OUTSTANDING  
**LOW LOSS**  
**HIGH FREQUENCY**  
**INSULATION**  
FOR OVER  
A QUARTER OF  
A CENTURY

MYCALEX is a highly developed glass-bonded mica insulation backed by a quarter-century of continued research and successful performance. Both pioneer and leader in low-loss, high frequency insulation, MYCALEX offers designers and manufacturers an economical means of attain-

ing new efficiencies, improved performance. The unique combination of characteristics that have made MYCALEX the choice of leading electronic manufacturers are typified in the table for MYCALEX grade 410 shown below. Complete data on all grades will be sent promptly on request.

MYCALEX is efficient, adaptable, mechanically and electrically superior to more costly insulating materials

- PRECISION MOLDS TO EXTREMELY CLOSE TOLERANCE
- READILY MACHINEABLE TO CLOSE TOLERANCE
- CAN BE TAPPED THREADED, GROUND, SLOTTED
- ELECTRODES, METAL INSERTS CAN BE MOLDED-IN
- ADAPTABLE TO PRACTICALLY ANY SIZE OR SHAPE

MYCALEX is available in many grades to exactly meet specific requirements

CHARACTERISTICS OF MYCALEX GRADE 410

Meets all the requirements for Grade L-4A, and is fully approved as Grade L-4B under Joint Army-Navy Specification JAN-1-10

Power factor, 1 megacycle	0.0015
Dielectric constant, 1 megacycle	9.2
Loss factor, 1 megacycle	0.014
Dielectric strength, volts/mil	400
Volume resistivity, ohm-cm	$1 \times 10^{15}$
Arc resistance, seconds	250
Impact strength, Izod, ft.-lb/in. of notch	0.7
Maximum safe operating temperature, °C	350
Maximum safe operating temperature, °F	650
Water absorption % in 24 hours	nil
Coefficient of linear expansion, °C	$11 \times 10^{-6}$
Tensile strength, psi	6000

MYCALEX is specified by the leading manufacturers in almost every electronic category

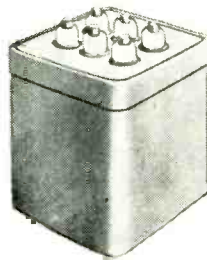

TRANSFORMER WITH MYCALEX-METAL ASSEMBLIES TO GIVE TIGHT SEAL

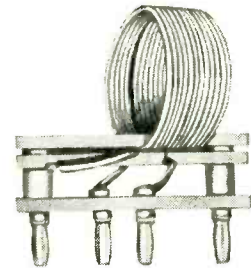

MYCALEX COIL HOLDER AND BASE

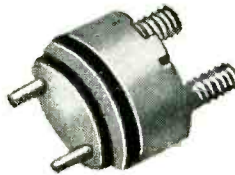

TERMINAL BASE ASSEMBLY FOR FIRE DETECTION EQUIPMENT

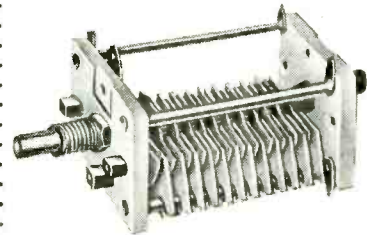

CONDENSER WITH MYCALEX LOW-LOSS END PLATES

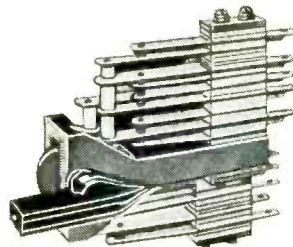

MULTI-POSITION LEVER SWITCH WITH MYCALEX SPACERS

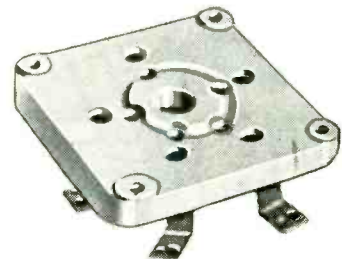

TUBE SOCKET OF MOLDED MYCALEX FOR HIGH FREQ. USE



## CORPORATION OF AMERICA

Owners of 'MYCALEX' Patents and Trade-Marks

Executive Offices: 30 Rockefeller Plaza, New York 20 • Plant and General Offices: Clifton, New Jersey

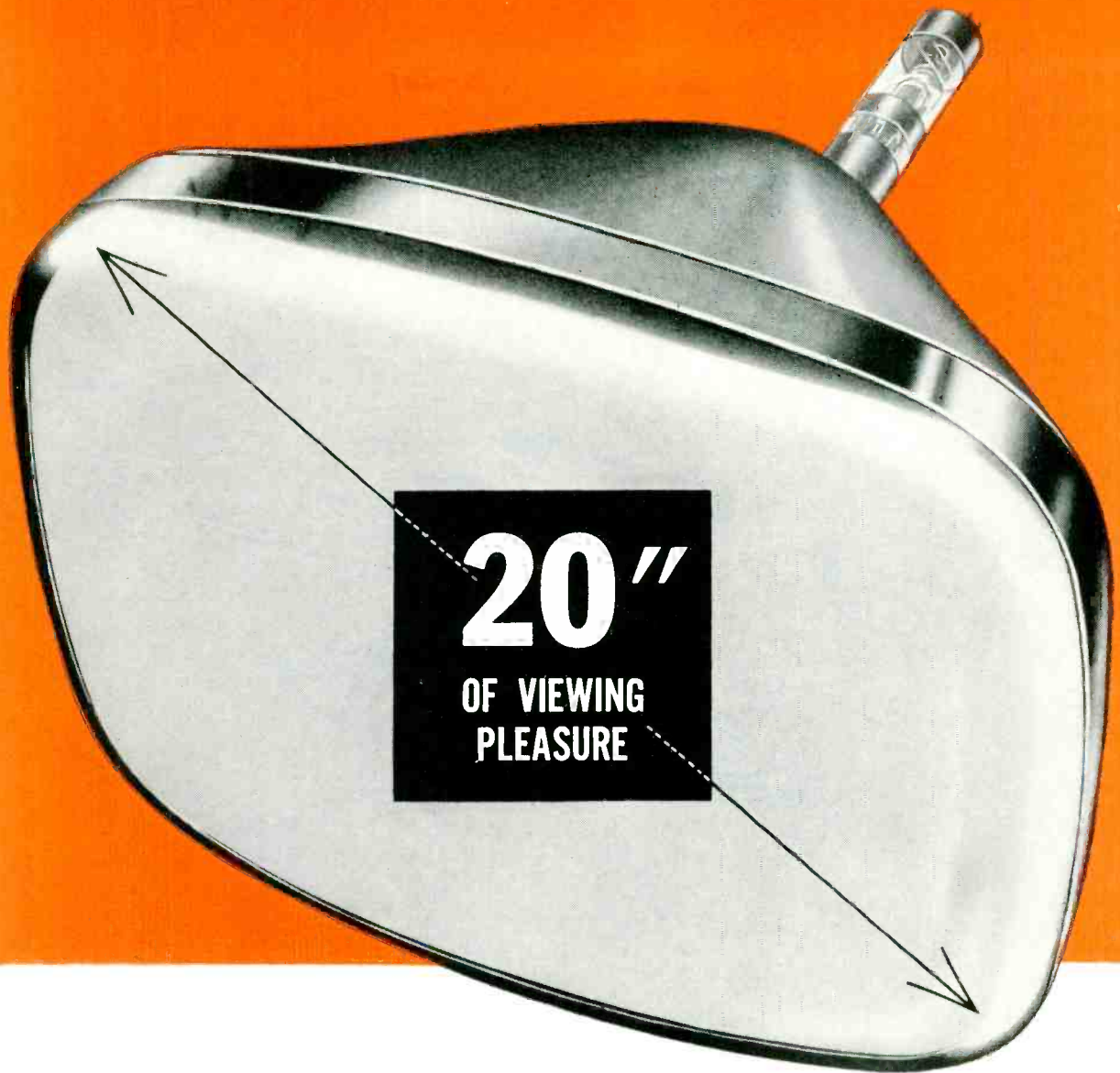

## the Du Mont type 20CP4

For the set that follows the "seventeen" in rectangular pictures, Du Mont supplies the "twenty" all-glass rectangular Type 20CP4.

Another in the series of Big-Picture Teletrons employing the NEW Bent-Gun for edge-to-edge sharpness that makes the difference in picture tubes of this size. The gray filter face plate improves contrast.

The first picture tube designed with the industry "standard" neck length of 7 $\frac{1}{2}$ ".

Our Commercial Engineering Department invites all design inquiries.

**DU MONT**  
*Teletrons*\*

Allen B. Du Mont Laboratories, Inc., Cathode-Ray Tube Division, Clifton, N. J.

\* Trademark



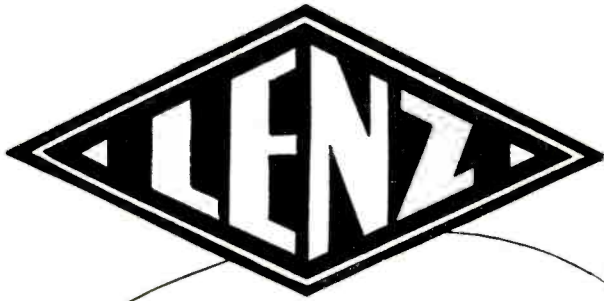

# Aircraft Electrical Wires & Cables

FOR POWER • LIGHTING  
INSTRUMENTS • ELECTRONIC EQUIPMENT

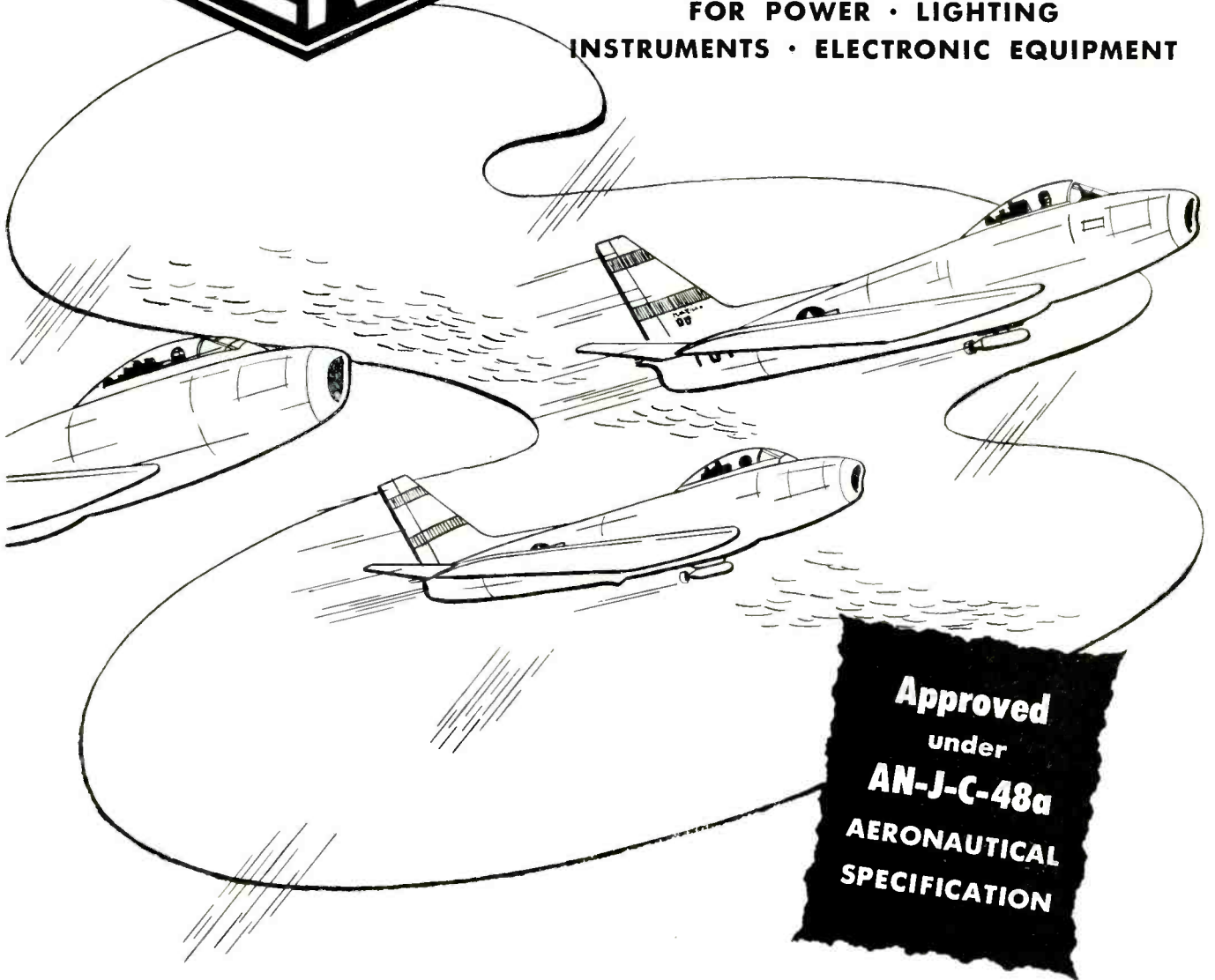

Lenz is producing electrically insulated wires, cords and cables of many types for Military Equipment, under approved Government Specifications.

With its extensive facilities and expert knowledge, gathered over almost a half century of wire and cable manufacture for the communications industry, Lenz is your ideal source for special and standard wire and cable products. Consultation on your requirements is invited!

## Hook-Up Wires and Special Cables for Aircraft Electronic Instruments

with	for
Tinned Copper Conductors	Radar Instruments
Extruded Plastic Insulation	Electrical Instruments
Cotton or Glass Braid Covered	Radio Receivers
Color Coded as desired	Radio Transmitters
Saturant and Lacquer Coating containing Fungicides	Fuselage Wiring

NOW ENJOYING ITS 47th YEAR OF SUCCESSFUL BUSINESS

**LENZ ELECTRIC**  
1751 North Western Avenue



**MANUFACTURING CO.**  
Chicago 47, Illinois

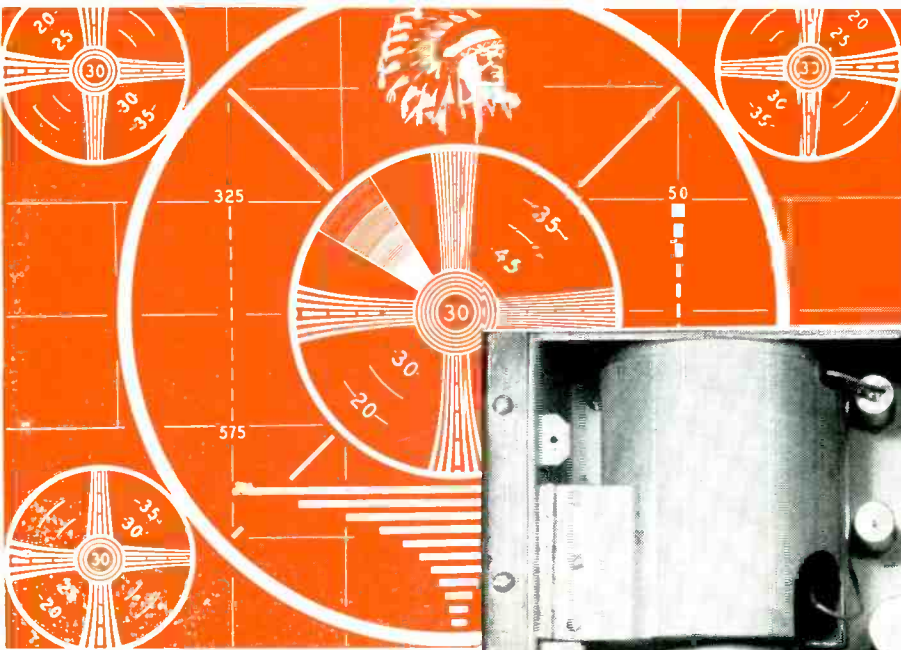

**Video  
Monoscope  
Camera  
TK-1A**

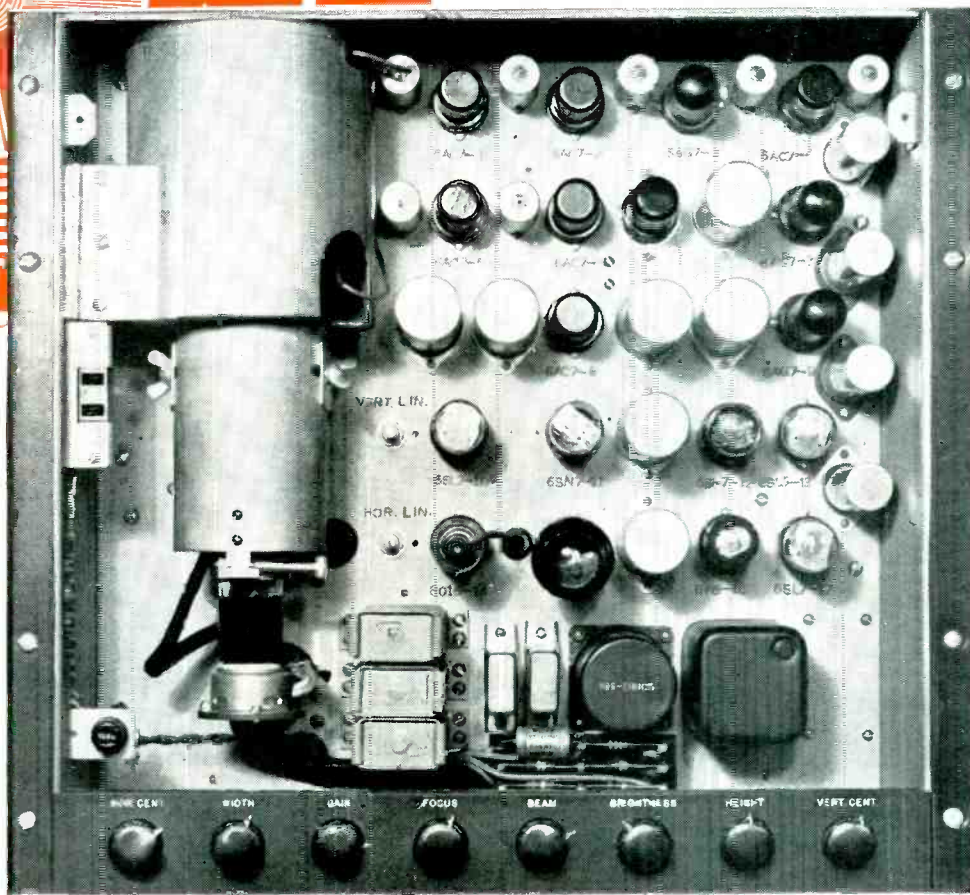

# ... "patternmaker" for the industry

The test pattern produced by RCA Monoscope Cameras is the standard by which picture quality has been judged since the beginning of electronic television . . . in TV stations . . . in laboratories . . . in TV receiver production.

These are the standard test-pattern cameras used by many TV receiver manufacturers. These are the standard "picture micrometers" used by TV stations to make precision measurements of video transmissions.

Deliberately designed to excel in all things, RCA Monoscope Cameras have earned the extraordinary re-

spect of television men. Evenly lighted patterns as steady as Gibraltar. Resolution as fixed as the cut of a diamond. Operation as reliable as a ship's chronometer.

Type TK-1A pictured here is RCA's newest Monoscope Camera—built to the highest standards known. It can be delivered to you with the familiar monoscope pattern (shown above)—or with a pattern of your own choice.

Ask your RCA Television Equipment Sales Engineer for prices. Mail the coupon for data.



**TELEVISION BROADCAST EQUIPMENT**  
**RADIO CORPORATION of AMERICA**  
**ENGINEERING PRODUCTS DEPARTMENT, CAMDEN, N. J.**

In Canada: RCA VICTOR Company Limited, Montreal

Radio Corporation of America  
Television Broadcast Equipment Section  
Dept. O-36, Camden, N. J.

Send me your technical bulletin on the RCA Type TK-1A Monoscope Camera.

Name \_\_\_\_\_

Company or station \_\_\_\_\_

Address \_\_\_\_\_

City \_\_\_\_\_ State \_\_\_\_\_



# VOLTAGE REGULATED POWER SUPPLIES

*For Industrial and Research Use*



## MODEL 510

Model 510 features TWO COMPLETELY INDEPENDENT REGULATED POWER SUPPLIES.

**OUTPUT DC FOR EACH SUPPLY:** 200-500 volts, 200 Ma.

**REGULATION:** ½% for both line and load variations.

**RIPPLE:** 5 millivolts.

**OUTPUT IMPEDANCE:** 2 ohms.

**OUTPUT AC FOR EACH SUPPLY:** 6.3 volts, 6 Amp., CT.

The supplies may be connected for series, parallel, or bucking operation.



## MODEL 245

**OUTPUT DC:** 200-500 volts, 200 Ma.

**REGULATION:** ½% for both line and load variations.

**RIPPLE VOLTAGE:** 5 millivolts.

**OUTPUT IMPEDANCE:** 2 ohms.

**OUTPUT AC:** 6.3 volts, 6 Amp., CT, unregulated.



## MODEL 103, MULTIPLE POWER SUPPLY

**TWO B SUPPLIES:** 0-300 volts, 75 Ma. each, 150 Ma. when paralleled. Ripple 10 millivolts. Unregulated.

**ONE C SUPPLY:** Minus 50 volts to plus 50 volts, 5 Ma. Ripple 5 millivolts. Unregulated.

**ONE FILAMENT SUPPLY:** 6.3 volts AC, 5 Amp.

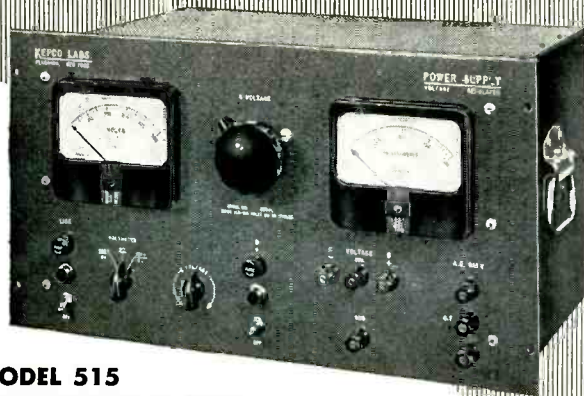

## MODEL 515

**B SUPPLY:** 0-500 volts, 200 Ma.

**REGULATION:** ½% for both line and load variations.

**RIPPLE:** 5 millivolts.

**OUTPUT IMPEDANCE:** 2 ohms.

**C SUPPLY:** 0-150 volts, 5 Ma.

**REGULATION:** 10 millivolts for line 105-125 volts.

½% for load at 150 volts.

**RIPPLE:** 5 millivolts.

**FILAMENT SUPPLY:** 6.3 volts AC, 10 Amp., CT.

This unit is available with a 300 Ma. B Supply; with or without C Supply.



## MODEL 315

**B SUPPLY:** 0-300 volts, 150 Ma.

**REGULATION:** ½% for both line and load variations.

**RIPPLE:** 5 millivolts.

**OUTPUT IMPEDANCE:** 2 ohms.

**C SUPPLY:** 0-150 volts, 5 Ma.

**REGULATION:** 10 millivolts for line 105-125 volts.

½% for load at 150 volts.

**RIPPLE:** 5 millivolts.

**FILAMENT SUPPLY:** 6.3 volts AC, 5 Amp., CT.



## MODEL 600

Model 600 features TWO INDEPENDENT REGULATED POWER SUPPLIES.

**OUTPUT DC FOR EACH SUPPLY:** 0-500 volts, 200 Ma.

**REGULATION:** ½% for both line and load variations.

**RIPPLE:** 5 millivolts.

**OUTPUT IMPEDANCE:** 2 ohms.

**OUTPUT AC FOR EACH SUPPLY:** 6.3 volts, 10 Amp., CT, unregulated.



Write for specifications on our complete line of power supplies

# KEPCO LABORATORIES, inc.

149-14-41st AVENUE

(Dept. K)

FLUSHING, NEW YORK

# It's a fact that

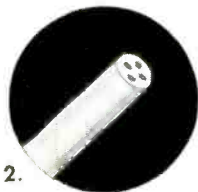

3.



An interesting fact of nature is that newborn opossums weigh not more than 4 grains and are not usually longer than one-half inch. Six of them can easily be held in a tablespoon.

1. The same spoon will contain several hundred ceramic screws 0.150" long, 0.086" screw diameter complete with slotted head, precision threads #2-56 and 0.018" diameter hole through the center. These have been successfully produced in ALSiMag in production quantities! (Illustration is enlarged approximately five times.)

2. ALSiMag ceramic tubes 0.035" O.D. with 4 holes 0.006" I.D. are regularly and economically produced within tolerances of  $\pm 0.002$ ". (Illustration enlarged approximately seven times.)

More than 70 different raw materials are kept in stock in five large warehouse areas for production of the versatile ALSiMag technical ceramics.

Over two million ALSiMag ceramic pieces are produced and shipped each day. On many days the production is well in excess of three million pieces.

More than five thousand completely different custom made designs are made in ALSiMag each year.

3. Glazed coil forms, 8" in diameter, 23½" long with various pitch threads are made to a tolerance of  $\pm 2\%$ , nothing less than  $\pm 0.12$ .

## ALSiMAG

TRADE MARK REG. U.S. PAT. OFF.

A leading designing engineer visited our plant to work out a particularly difficult problem. Within a week, hand made samples were produced which fully met his requirements.

Asked what had impressed him most he said: "Your amazing versatility. We had no idea this could be done at all and you have shown us several ways you can do it. We have done business with you for years but until this visit I had no idea

of the control you have over physical characteristics of your material. Your ability to economically produce complex shapes within close tolerances is far ahead of anything we have ever known. And I am greatly impressed by the modern equipment and the tremendous size of this business which makes nothing but technical ceramics."

We believe that you, too, will find here the answer to almost any technical ceramic problem.

### AMERICAN LAVA CORPORATION

49TH YEAR OF CERAMIC LEADERSHIP  
CHATTANOOGA 5, TENNESSEE

OFFICES: METROPOLITAN AREA: 671 Broad St., Newark, N. J., Mitchell 2-8159 • CHICAGO, 228 North LaSalle St., Central 6-1721  
PHILADELPHIA, 1649 North Broad St., Stevenson 4-2823 • LOS ANGELES, 232 South Hill St., Mutual 9076  
NEW ENGLAND, 38-B Brattle St., Cambridge, Mass., Kirkland 7-4498 • ST. LOUIS, 1123 Washington Ave., Garfield 4959



# establish the signal's D-C LEVEL

...and measure its a-c and d-c  
components directly  
from the oscillograph

you should see...

this!

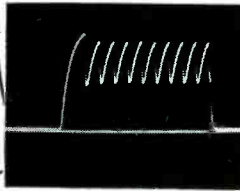

Both a-c and d-c components are displayed through the d-c amplifiers of the Type 340-H. Base line represents zero volts.

not  
this!

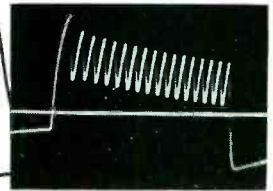

The same signal, applied through a-c amplifiers exhibits a shifted reference line and tilt of the signal which make the oscillogram difficult to interpret.

# DUMONT type 304-H

...to make direct measurements



## THE TYPE 264-B VOLTAGE CALIBRATOR

Simply by applying its square-wave output to the oscillograph and producing a deflection equal to that of the signal, the amplitude of the signal may be read, in volts, directly from the calibrated dial of the Type 264-B. Or the Type 264-B will calibrate your oscillograph to read directly in volts per inch.

...to obtain permanent records



## THE TYPE 296 OSCILLOGRAPH-RECORD CAMERA

To complete the study of the signal, permanent records, such as those above, are obtained most efficiently with this inexpensive, single-frame, 35-mm. camera. Operation of the camera is simple and foolproof; construction is compact and rugged. A high-quality f/2.8 coated lens is used, and focus is fixed for best oscillographic results.

The "Standard of Performance" for general-purpose cathode-ray oscillographs.

To study signals containing both a-c and d-c components, direct-coupled amplifiers such as those of the Type 304-H must be used. D-C amplifiers will maintain the true d-c level of the signal and display the actual relationship between the d-c and a-c components of the signal. Then by calibration of the Type 304-H with the Du Mont Type 264-B Voltage Calibrator, these components may be measured directly from the screen of the instrument.

Features such as driven sweeps, sweep expansion, extremely slow sweep speeds, and stabilized synchronization have made the Type 304-H the outstanding general-purpose cathode-ray oscillograph. Its sensitivity of 10 rms millivolts per inch and its versatility often eliminate the need for a second instrument to perform functions not within the range of the ordinary general-purpose oscillograph.

Portability contributes highly to the usefulness of the Type 304-H, especially in field work requiring good performance and in the laboratory where it serves many benches. The Type 304-H measures 13½" high, 8⅞" wide, 19" deep, and weighs only 50 pounds.

Write today for catalog...

Instrument Division, Allen B. Du Mont Labs., Inc.  
1000 Main Avenue, Clifton, N. J., U. S. A.

# DUMONT

20<sup>th</sup>  
YEAR  
AS PIONEER

# in Oscillography

# 4 Truarc Rings save \$2.41 unit cost, Simplify Design, Assembly, Maintenance

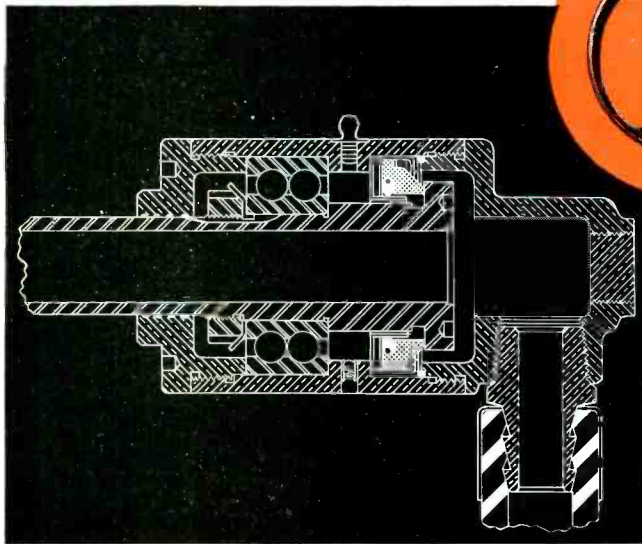

**Conventional Way.** This design died on the drawing boards, because the Deublin Company, Northbrook, Ill., found the simplified design, using Truarc Rings, superior and more economical.

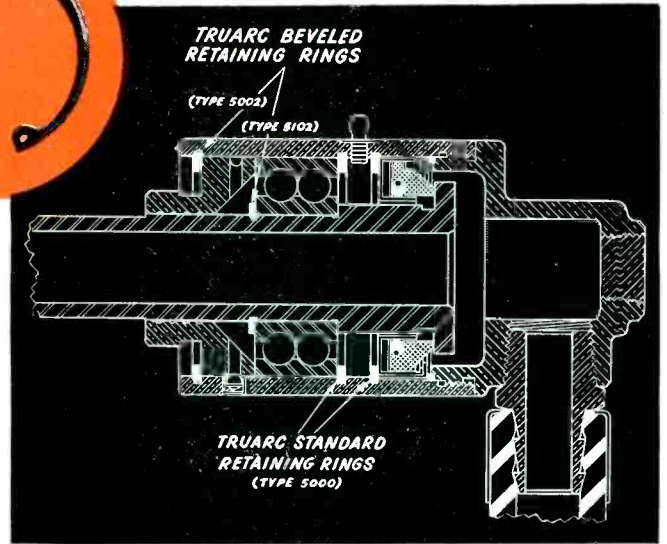

**Truarc Way.** Truarc Beveled Retaining Ring holds cap in place, takes up end play, locks entire assembly. Second Beveled Ring positions ball bearing on rotor. 2 standard Truarc Rings position bearing and removable seal, eliminate shoulders, permit manufacture of housing from strong, non-porous, easily machined brass tubing. Unit can be serviced in minutes simply by removing 2 Truarc Rings.

## HOW \$2.41 WAS SAVED

<b>Materials saved</b>	
decreased wall thickness of housing . . . . .	\$ .79
eliminated bearing lock nut and washer . . . . .	.18
	<u>.97</u>
<b>Machine operations eliminated</b>	
Bore, undercut, and tap cap end of housing . . . . .	.39
Locate cap on arbor, and chase threads . . . . .	.28
Drill spanner wrench holes . . . . .	.10
Cut thread on rotor for lock nut . . . . .	.09
Mill slot in thread for tang on lock washer . . . . .	.18
Drill spanner wrench holes in rotor . . . . .	.10
	<u>1.14</u>
<b>Assembly operations eliminated</b>	
Install lock washer, tighten lock nut, bend lug . . . . .	.20
Assemble cap into housing . . . . .	.10
	<u>.30</u>
<b>TOTAL SAVINGS</b> . . . . .	<b>\$2.41</b>

**T**HE Deublin Union—a rotating joint for steam, air, or water—is simple, rugged, easy to service. 4 Waldes Truarc Rings hold entire unit together, permit simplified design, cut unit cost \$2.41.

Improve and simplify your own product design with Truarc Rings, and you too will cut costs. Wherever you use machined shoulders, nuts, bolts, snap rings, cotter pins, there's a Waldes Truarc Ring that does a better job of holding parts together.

Truarc Rings are precision engineered. Quick and easy to assemble, disassemble. Always circular to give a never-failing grip. They can be used over and over again.

Find out what Truarc Rings can do for you. Send your blueprints to Waldes Truarc engineers for individual attention, without obligation.

Visit the Truarc Exhibit, Booth 358,  
at the IRE Radio Eng. Show, Grand  
Central Palace, N. Y., March 19-22.

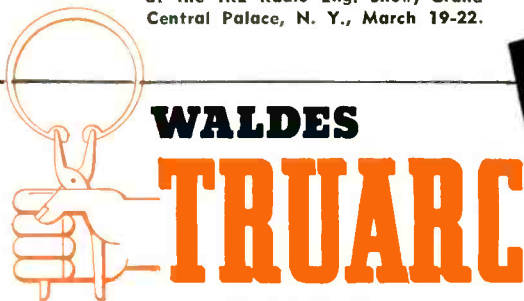

REG. U. S. PAT. OFF.

## RETAINING RINGS

WALDES KOHINOOR, INC., LONG ISLAND CITY 1, NEW YORK

WALDES TRUARC RETAINING RINGS ARE PROTECTED BY THE FOLLOWING PATENT NUMBERS:

U. S. PATENTS 2,382,948; 2,420,921; 2,411,701; 2,487,803; 2,487,802; 2,491,306 AND OTHER PATENTS PENDING

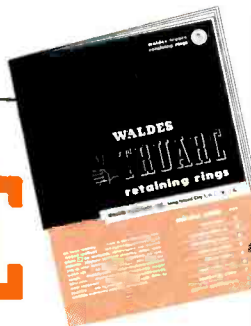

Waldes Kohinoor, Inc., 47-16 Austel Place E033  
Long Island City 1, N. Y.

Please send the new catalog  
on Waldes Truarc Retaining  
Rings.

Name \_\_\_\_\_

Title \_\_\_\_\_

Company \_\_\_\_\_

Business Address \_\_\_\_\_

City \_\_\_\_\_ Zone \_\_\_\_\_ State \_\_\_\_\_

4KW



a complete line of

hermetically  
sealed  
oil-filled

### Rectifiers

Small, lightweight a-c to d-c power supply units for use with cathode-ray tubes, television camera tubes and radar indicator scopes, electron microscopes, and similar jobs. Typical outputs are 7, 9 and 13 kv. Low regulation—the 7-kv unit illustrated does not exceed 3.5% regulation per 0.1 milliampere load, holds ripple on output voltage to less than 1%. Size, only 6" x 6" x 7"; weight 8 lb.

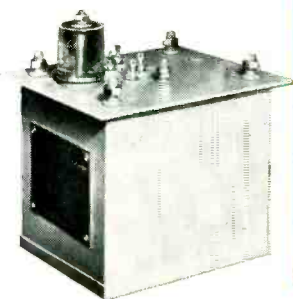

## HIGH-VOLTAGE COMPONENTS

### Pulse Transformers

Pulse transformers for use with either hard-tube or line-type modulators. Available in voltage ratings of 10 kv or above. These units are ideal for radar applications, stepping up or down, impedance matching, phase reversing and plate-current measurements. Also suitable for nuclear physics research work, television and numerous special applications in and out of the communications fields.



### Resonant Reactors

Resonant-charging reactors, accurately designed and constructed for radar service. Usually required in ratings of 40 kv and below, 1 ampere and below and 300 henries and below. Higher ratings are being built, and can be considered. When required, small- and medium-size designs can be provided with 3 to 1 range of inductance adjustment.

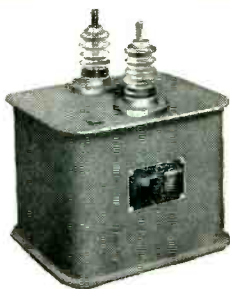

### Filament Transformers

Filament transformers available with or without tube socket mounted integral with the high-voltage terminal. Low capacitance. Ratings to match any tubes; insulated to practically any required level.



Illustrated here are typical high-voltage components manufactured by General Electric. They can be built to meet Armed Services requirements. All are oil-filled and hermetically sealed—with excellent ability to withstand mechanical shocks and to operate continuously for long periods in widely varying temperatures. Apparatus Dept., General Electric Company, Schenectady, N. Y.

Your inquiries will receive prompt attention. Since these components are usually tailored to individual jobs, please include with your inquiry, functional requirements and any physical limitations. *Write to Apparatus Dept., 42-328A, General Electric Co., Pittsfield, Mass.*

GENERAL  ELECTRIC

401-63

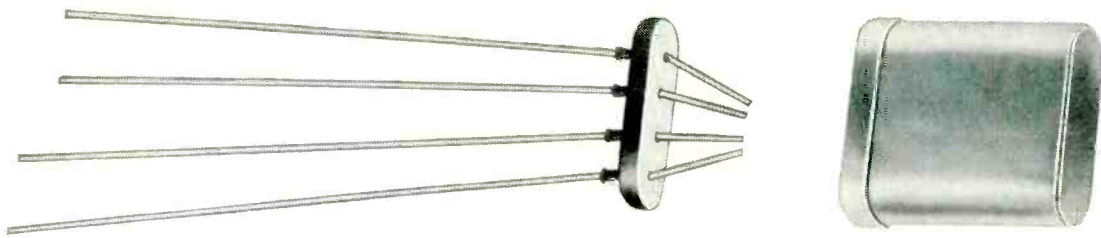

**The Only Seals  
You Can Hot Tin Dip  
at 525° F. for Easy  
Assembly Soldering,  
for a Strain and  
Fissure-Free Sealed  
Part with Resistance  
of over  
10,000 Megohms!**

*Recent*

**Hermetic Seal Achievements...**

*by the world's leading  
supplier of quality headers*

Whether your specifications call for the simplest or the most complicated hermetic seals, call on the source used by this country's leading industries. Hermetic's experience, know-how and engineering talent are unrivaled in this field. Such specialization assures you of quality hermetic headers in unlimited shapes that withstand -55° F. sub-zero conditions, swamp test, temperature cycling, high vacuum, high pressure, salt water immersion and spray, etc.

*Important: Terminals and Headers are available  
in RMA Color Code.*

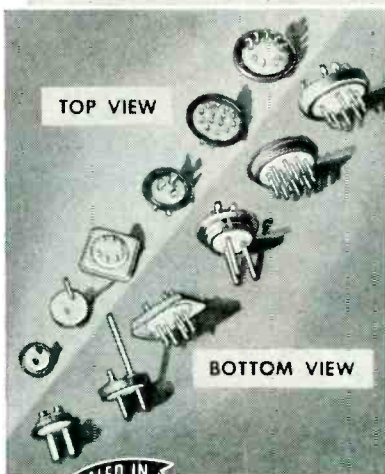
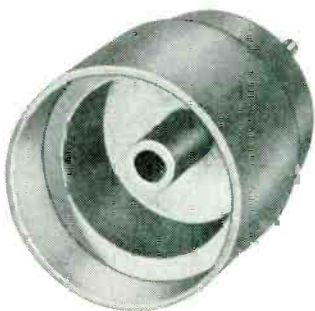
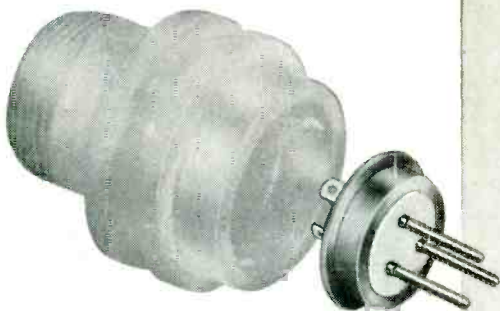

TOP VIEW

BOTTOM VIEW



**Free!**

Write for your copy  
of the most complete  
catalog ever produced  
on hermetic seals.

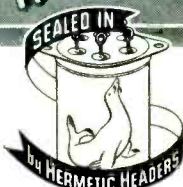

**Hermetic Seal Products Co.**

31-33 South 6th Street, Newark 7, New Jersey

VISIT HERMETIC'S BOOTH NUMBER 129 AT THE 1951 I.R.E. SHOW, GRAND CENTRAL PALACE, MARCH 19-22



Floyd Makstein, field engineering manager at **Emerson** recommends

# Simpson MODEL 480 GENESCOPE

## FOR TV-FM SERVICING

This is what Floyd Makstein of EMERSON says about the Simpson Model 480 Genescope: . . . "The Simpson Model 480 Genescope far surpasses the standards required in the servicing and aligning of all TV-FM receivers.

The wide frequency response and the 25 millivolt sensitivity of the oscilloscope, combined with the required fundamental signal sources which are provided in the AM & FM oscillator sections, simplifies the accurate aligning of all TV receivers, including those with intercarrier systems.

In addition, the large, easy-to-read dials, having a 20-1 vernier control and 1000 division logging scale, cuts down on servicing time."

Mr. Makstein concludes . . . "The compactness of the complete unit will be a big factor in many of the service shops where space is at a premium. We are sure that the whole

TV industry appreciated your efforts in raising the engineering standard in servicing." Emerson Service personnel *know* that modern FM and TV development and servicing demand test equipment made to the most exacting standards.

They prefer the Simpson Model 480 Genescope because it is the most accurate, flexible and convenient instrument available. The Genescope will render many years of uninterrupted service and always produce accurate results.

### SIMPSON ELECTRIC COMPANY

5200 W. Kinzie St. • Chicago 44, Illinois • Phone: COlumbus 1-1221

In Canada: Bach-Simpson, Ltd., London, Ont.

#### THESE RANGES SHOW HOW MUCH THE SIMPSON GENESCOPE CAN DO FOR YOU

##### FREQUENCY MODULATED OSCILLATOR

Band A: 2-120 megacycles  
Band B: 140-260 megacycles  
Sweep width variable from zero to 15 megacycles  
Sweep rate 60 cycles per second  
Specially designed frequency sweep motor  
Continuously variable attenuator  
Crystal calibrator: 5 megacycles  $\pm$  .05%  
Audio Oscillator 400 cycles  
Output Impedance 75 ohms  
Step attenuator for control of output

##### AMPLITUDE MODULATED OSCILLATOR

Band A: 3.3-15.6 megacycles  
Band B: 15-75 megacycles  
Band C: 75-250 megacycles  
30% modulation at 400 cycles or unmodulated  
Continuously variable attenuator  
Visual method of beat frequency indication

##### OSCILLOSCOPE

Vertical sensitivity: 25 mv per inch  
Horizontal sensitivity: 70 mv per inch  
Linear sweep frequency: 2 cycles to 60 kilocycles  
60 cycle sine sweep  
Frequency essentially flat to 200 KC. usable to over 3 megacycles

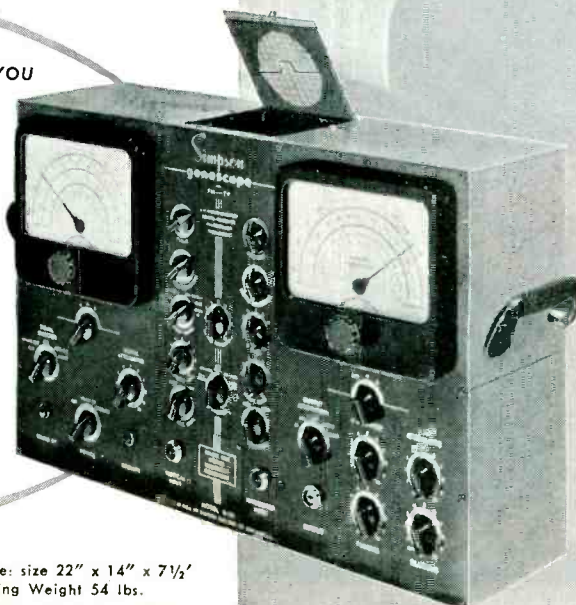

Simpson Model 480 Genescope: size 22" x 14" x 7 1/2"  
Weight 45 lbs. Shipping Weight 54 lbs.

DEALER'S NET PRICE complete with Test Leads and Operator's Manual, \$395.00.



**FROM CIBA RESEARCH**

**NEW!**

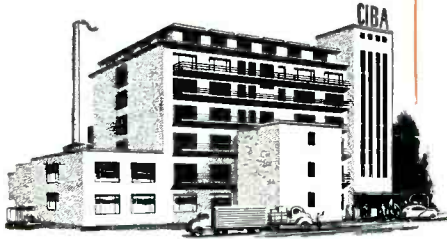

*A new group of resins of the Ethoxyline class with outstanding properties for*

**Bonding . . . Casting . . . Coating**



# Araldite\* RESINS

*Araldite Resins* provide a wide range of practical application for simplifying fabricating methods and improving results. All of the Araldite Resins harden to form thermosetting compounds without evolution of water or volatile matter, and the general result is a resin of high resistance to corrosion with exceptional adhesive properties toward metals, ceramics and other materials and high alkali and acid resistance.

ARALDITE TYPES I & XV*	ARALDITE TYPES 101 & 102**	ARALDITE CASTING RESIN B	ARALDITE 985E
<p>Very high strengths. No pressure needed. Wide tolerances of hardening times and temperature. Adaptable to soldering technique by "flame curing". Bonds well to glass, ceramics, aluminum, brass, etc.</p> <p>*Adaptable to spraying, brushing, or dipping techniques. Unaffected by alkalis, most acids and common solvents.</p>	<p>No volatile solvents. Sets in hermetically sealed places without shrinkage. Good adhesion to glass, metals and plastics. Sets at room temperature. Used as a china cement.</p> <p>**Sets without pressure at room temperature. Can be brushed, dipped or sprayed.</p>	<p>Has been used for bonding glass-glass, glass-metal where lower curing temperatures than Type I were required.</p>	<p>Bakes with strong adhesion to metals, high elasticity and flexibility. Unaffected by alkalis, most acids and solvents. non-toxic, odorless and tasteless used as linings for cans, collapsible tubes and corrosion resistant formulations for protection of magnesium, castings, etc.</p>
<p>Bonds heat resistant plastics for high strength. Type I is relatively inflexible and is less suitable for bonding cloth-wood, cloth-metal than Type 101.</p> <p>*Similar to Type I but liquid form allows easier handling in some cases.</p>	<p>Used as a casting resin with low shrinkage properties. Sets at room temperature.</p> <p>**Has been used as an abrasion resistant, alcohol and alkali resistant coating.</p>	<p>A resin with low shrinkage (0.5-2%) Thermosetting High adhesive properties towards metal inserts. Very good dielectric strength. High acid and alkali resistance. (.7 ft. lbs/in IZOD.)</p>	<p>Araldite 985E has successfully sealed porous castings of Diesel engines and similar castings in aluminum, magnesium, steel, etc.</p>
<p>High adhesion. Used in making inks for glass and melamine plastics. Moisture resistance is high.</p> <p>*Type XV can be used in impregnating and the manufacture of low pressure laminates.</p> <p>*Type XV is readily adaptable to sealing of porous castings of aluminum, steel, etc.</p>	<p>When mixed with filler used as smoothing compounds for body work on aluminum plane fuselages and on aluminum busses. When filled with wood flour used as a shrinkless plastic wood for wood filling and finishing.</p>	<p><i>Because Araldite Resins are produced in three easy-to-use commercial forms, the exceptional properties of these new but already extensively applied resins provide fabricators seeking new, improved, simplified, time-and-money saving bonding, casting and coating mediums, with exceptional opportunities to put their ideas to work.</i></p>	

\* Araldite is Trade Mark of Ciba Company Inc.

SEND THIS COUPON . . . or write us on your company letterhead . . . for complete technical data on the physical properties and recommended procedures for the successful use of Araldite Resins for your own fabricating needs.



**CIBA COMPANY INC.,** Plastics Division  
627 Greenwich Street, New York 14, N. Y.

Please send me without obligation the new Ciba Araldite Resins Technical Bulletin. We are particularly interested in data on Araldite Resins applications for Bonding  Casting  Coating

Name.....

Company..... Title.....

Address.....

# Ciba



# LET'S FACE IT!

## THE KEYNOTE IS PRODUCTION

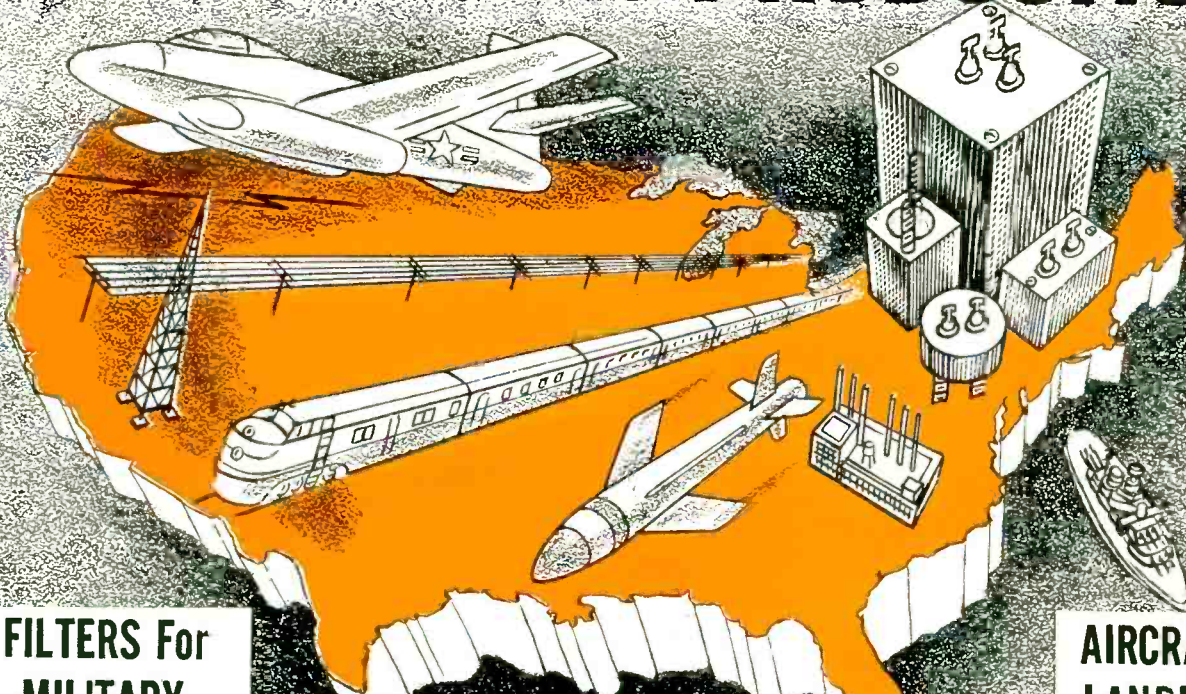

**FILTERS For  
MILITARY  
APPLICATIONS**

**FACSIMILE**

**TELETYPE**

**GUIDED  
MISSILES**

**TELEMETERING**

### *Burnell & Co* TOROIDAL COILS AND FILTERS

Regardless of what may happen to the international situation in the near future, there will definitely be a continued emphasis on preparedness. This, naturally, means greater industrial output and more Electronics and communications equipment than ever before.

Audio filters and similar networks are the critical components in a large part of military electronic equipment and realizing this, Burnell & Company is taking every possible step to increase its production of these networks to forestall problems in delivery arising from suddenly increased demands. Our high standards of quality will not be lowered in our expansion program, on the contrary, all the military requirements for reliability in service will be carefully fulfilled.

You can depend on it, you will enjoy the "Burnell Customer Service" as usual.

**AIRCRAFT  
LANDING  
SYSTEMS**

**TELEGRAPH**

**TELEPHONE**

**CONTROL  
EQUIPMENT**

**SONAR**

*Exclusive Manufacturers  
of Communications  
Network Components*



***Burnell & Company***

**YONKERS 2, NEW YORK**

CABLE ADDRESS "BURNELL"



*Something New*

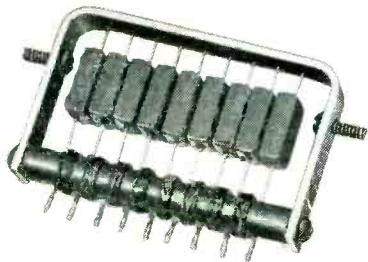

**SPECIAL DELAY LINES**

Lumped delay lines "tailored" to specific applications have been announced by the Shallcross Manufacturing Co., Collingdale, Pa. A typical unit consists of eight pie-section low-loss filters having a rise time of 0.04 microseconds and a total delay of 0.3 microseconds. Maximum pulse voltage is  $\pm 100$  volts and impedance is 500 ohms. Cutoff frequency is 8.5 megacycles and the maximum operating frequency approximately 2 megacycles based on a pulse delay error of not more than 2%. The unit consists of eight universally-wound coils of 3-strand #41 Litz wire and nine low T.C. silver mica capacitors. Many other types can be supplied.



**NEW SHALLCROSS WHEATSTONE-MEGOHM BRIDGE**

The new Shallcross 635-A Wheatstone-Megohm Bridge is a versatile direct-reading instrument for accurate measurements between 10 ohms and 1,000,000 megohms. It can be used to measure resistance elements and insulation resistance and to determine volume resistivity of materials. The instrument is basically a Wheatstone Bridge used in conjunction with a d-c amplifier. Two built-in power supplies operating on 115 volts, 60-cycles automatically provide the correct bridge voltages for the high and low ranges. Full information is available from the Shallcross Manufacturing Co., Collingdale, Pa.



**METAL-ENCASED RESISTORS**

Flat, metal-encased, Type 265-A wire-wound power resistors introduced by the Shallcross Manufacturing Company, Collingdale, Pa. are space wound, have mica insulation, and are encased in aluminum. At 175° C. continuous use they are conservatively rated for 7½ watts in still air and 15 watts mounted flat on a metal chassis. Write for Bulletin 122. (ADV.)

**SHALLCROSS MATCHES YOUR Precision Resistor Requirements!**



... for real dependability on **STANDARD INDUSTRIAL USES**

...over 40 economical standard types and sizes, each available in numerous mechanical and electrical adaptations. Write for Shallcross Data Bulletin R3A.

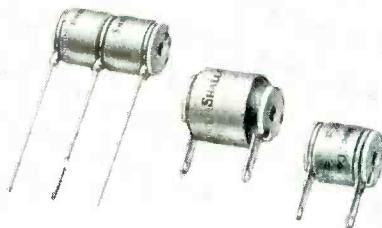

... for **MINIATURIZATION PROGRAMS**

For years, Shallcross has led the way in the production of truly dependable close-tolerance, high-stability resistors in miniature sizes. Standard and hermetically sealed types are available.



... for **SPECIAL ASSEMBLIES**

Shallcross regularly produces hundreds of special precision resistor types including precision power resistors, resistors with axial or radial leads and multi-unit strip resistors (illustrated) with either inductive or non-inductive windings.

... for **JAN EQUIPMENT**

Shallcross is in constant touch with the latest military precision resistor requirements. The present line includes 13 types designed for JAN characteristic "B" and 4 types for characteristic "A".

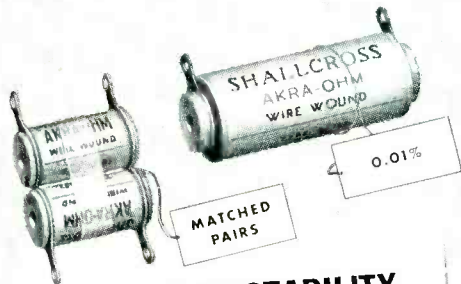

... for **HIGH-STABILITY APPLICATIONS**

Many Shallcross Akra-Ohm resistors are available with guaranteed tolerance to 0.01% and stability to 0.003%. Matched pairs and sets are supplied to close tolerances.

**SHALLCROSS**

**SHALLCROSS MANUFACTURING COMPANY**  
COLLINGDALE, PA.

See us at Booths 280-281, I.R.E. Show



# ELECTRONIC Precision METAL PARTS

by

## Haydu BROTHERS

Regardless of the complexity of the parts you need, Haydu Brothers possess the design and engineering skill, the facilities, the trained operators and the down-to-earth, machine-shop "know how" necessary to fill your requirements promptly, efficiently, and economically. Whether you need precision machine parts, small metal stampings, deep-drawn and four-slide parts, screw machine made parts, or formed wire parts, Haydu Brothers will handle your entire problem from die-making through production of the finished parts to specified tolerances. Our modern, high-speed equipment in the hands of skilled personnel is your assurance of quick and dependable fabrication -- in even the most difficult metals.

Our technical staff is always available to you for design of special equipment, or for consultation on production problems. Your inquiry concerning a specific item is invited.

Some items  
from current production . . .

- (1) **Small metal stampings\***— intricate or simple, Haydu's modern presses insure fast, accurate, volume production in monel, nickel, molybdenum, tungsten, stainless steel, copper, carbonized nickel, and other metals.
- (2) **Precision machine parts\***— in even the most difficult materials (molybdenum, tungsten, ambraloy, tantalum, kovar, nichrome, mishmetal, etc.) are tooling problems well within the scope of Haydu experience.
- (3) **Formed wire parts\***— from .004" to .080" in diameter in a wide range of materials. These are made to your exact blueprint specifications.
- (4) **Drawn, four-slide parts\***— perfectly produced to close tolerances on correctly designed dies for high-speed fabrication. Complete, modern facilities for deep-drawing.
- (5) **Screw machine parts\***— automatic and hand screw equipment give an almost unlimited range of size, shape, and finish, while maintaining closest tolerances.

\*All Haydu metal parts production undergoes rigid inspection for assurance of complete accuracy.



# HAYDU BROTHERS

PLAINFIELD • NEW JERSEY



Radio Engineering Show  
Grand Central Palace

Booth No. 82

New York City

**TOM JACOBS, Owner**  
**Apex Radio Shop**  
**Detroit, Michigan**

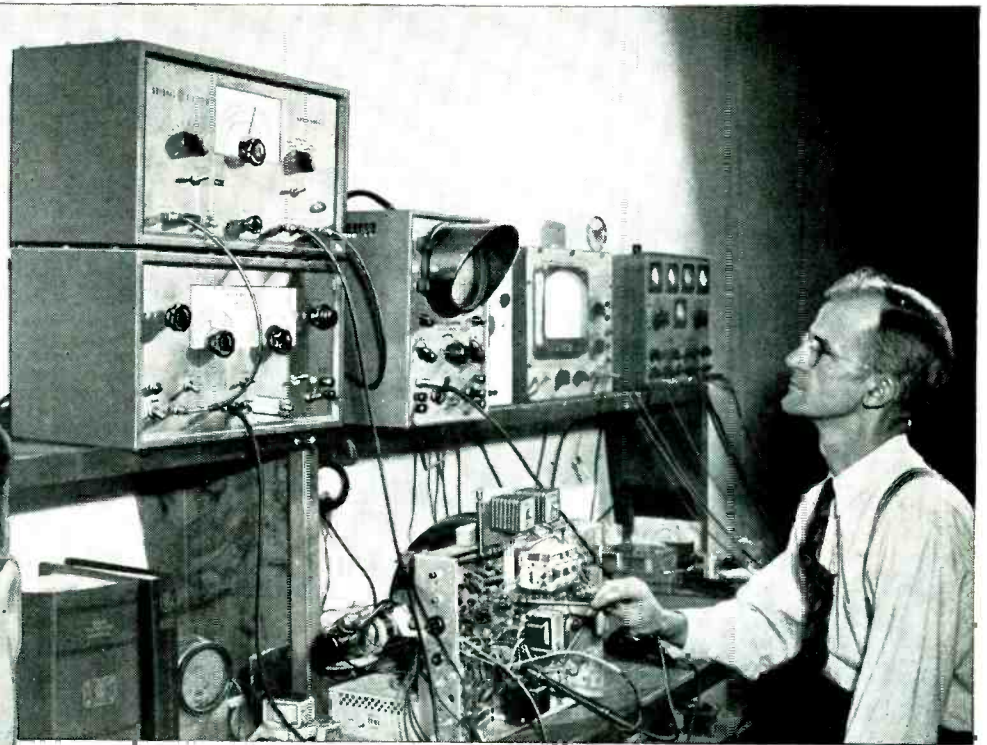

***“200% MORE TV BUSINESS  
 --NO INCREASE IN OVERHEAD!”***



“With no increase in trained personnel, we tripled our TV service business in 6 months. The answer lies in our G-E Test Equipment. “The *Scope* is the best trouble-shooter on the market . . . it holds a steady trace—it’s stable—you can overload it and it recovers instantly. The *Variable Permeability Sweep* is extremely simple to operate, and with the crystal-controlled

*Marker Generator* we always get accurate and reliable results. While keeping profits up, the G-E Test Package has cut our service time in half!”  
 Hundreds of TV dealers and servicemen use G-E Test Equipment to turn out clean, accurate jobs that keep customers satisfied and put money in the till. Call your G-E distributor or mail coupon today for full information.

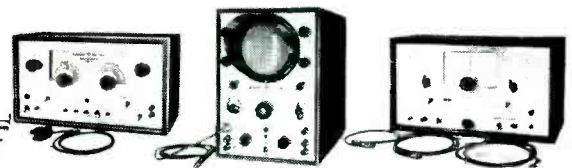

*You can put your confidence in—*  
**GENERAL  ELECTRIC**

General Electric Company, Section 431  
 Electronics Park, Syracuse, New York  
 Rush me latest bulletins plus price information on  
 General Electric test equipment.

NAME.....  
 ADDRESS.....  
 CITY.....STATE.....



# MILDEW

# Failed...

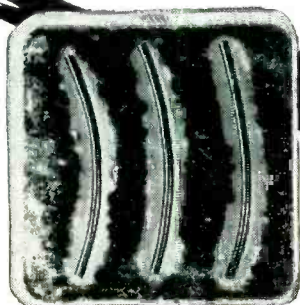

Shows treated Syntholvar Extruded Tubing



Shows untreated Syntholvar Extruded Tubing

## NOW...

## EXTRUDED VINYL TUBING that's *MILDEW RESISTANT!*

We can now supply you with a mildew resistant Syntholvar Extruded Vinyl Insulating Tubing. This will be good news to many of our customers — those who have electrical insulation problems where protection from mildew or fungus is essential.

Proof of the resistance of this new extruded tubing to fungi and bacteria is shown in the unretouched photographs of a 28-day Petri dish test. Note in the top picture how the treated tubing has completely resisted attack, whereas the untreated tubing is well covered with fungi and bacteria.

If you have a problem of this nature, we'll be glad to send you a test sample without charge.

**Varflex**  
**CORPORATION**

Makers of  
Electrical Insulating  
Tubing and Sleeving

**VARFLEX**  
Corporation

308 N. Jay St.

Rome, N. Y.

**MEMBER OF NEMA**

*For easy assembly... dependable performance*

# ERIE RESISTOR COMPONENTS

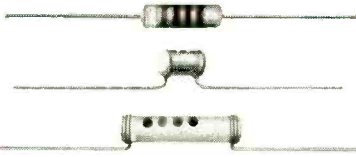

Erie "GP" <sup>\*</sup>Molded Insulated Ceramicon\*  
5 MMF—5,000 MMF  
Erie "GP" Dipped Insulated Ceramicon  
5 MMF—5,000 MMF  
Erie "GP" Non-Insulated Ceramicon  
5 MMF—5,000 MMF

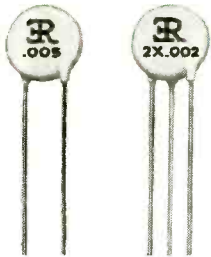

Erie Disc Ceramicon  
Up to .01 MMF

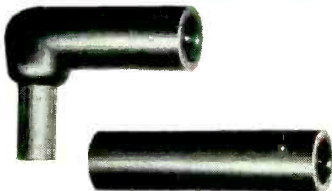

Types L-4, L-7, S-5 Suppressors  
for Spark Plugs and Distributors

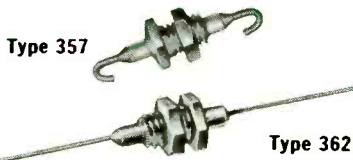

Feed-Thru Ceramicon  
5 MMF—1,000 MMF  
5 MMF—1,500 MMF

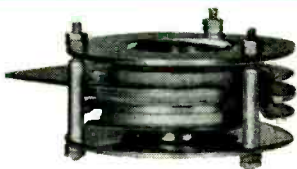

Type 3688  
High Voltage Ceramicon  
Up to 15,000 Volts  
WORKING

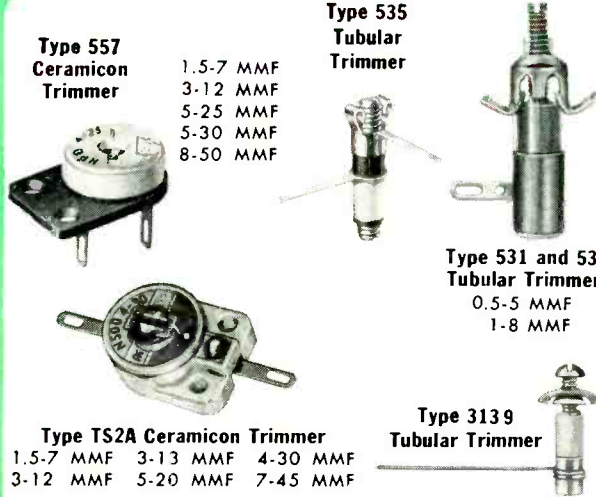

Type 557  
Ceramicon  
Trimmer  
1.5-7 MMF  
3-12 MMF  
5-25 MMF  
5-30 MMF  
8-50 MMF

Type 535  
Tubular  
Trimmer

Type 531 and 532  
Tubular Trimmers  
0.5-5 MMF  
1-8 MMF

Type TS2A Ceramicon Trimmer  
1.5-7 MMF 3-13 MMF 4-30 MMF  
3-12 MMF 5-20 MMF 7-45 MMF

Type 3139  
Tubular Trimmer

Erie Resistor Components are designed with definite objectives in mind: they must be accurate and well within the tolerances required for their application; they must be reliable for sustained satisfactory service based on time proven life tests; they must be compact and sturdy for easy installation on the assembly line and in the service shop.

Erie manufactures a complete line of Ceramic and Button Mica Capacitors for transmitter and receiver applications: Fixed Ceramic and Mica Capacitors, Variable Ceramic Capacitors, Carbon Suppressors, Custom Injection Molded Plastic Knobs, Dials, Bezels, Name Plates and Coil Forms. Complete technical information on request.

\*Ceramic, Hi-K, GP, and Plexicon are registered trade names of Erie Resistor Corporation.

*Electronics Division*  
**ERIE RESISTOR CORP., ERIE, PA.**  
LONDON, ENGLAND • TORONTO, CANADA

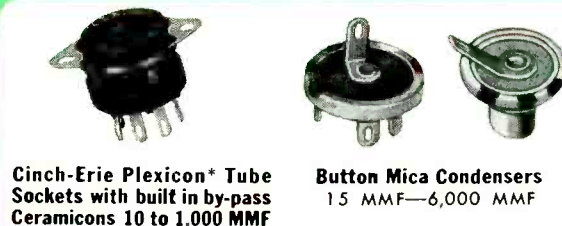

Cinch-Erie Plexicon\* Tube  
Sockets with built-in by-pass  
Ceramicon 10 to 1,000 MMF

Button Mica Condensers  
15 MMF—6,000 MMF

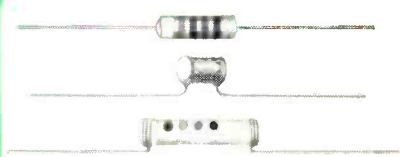

Temperature Compensating  
Molded Insulated Ceramicon  
0.5 MMF—550 MMF  
Temperature Compensating  
Dipped Insulated Ceramicon  
0.5 MMF—1,800 MMF  
Temperature Compensating  
Non-Insulated Ceramicon  
0.5 MMF—1,800 MMF



Type 720A  
Types 323 and 324  
Type 2322  
Type 2336  
Type 325  
Insulated  
Erie Stand-Off Ceramicon  
5 MMF—5,000 MMF

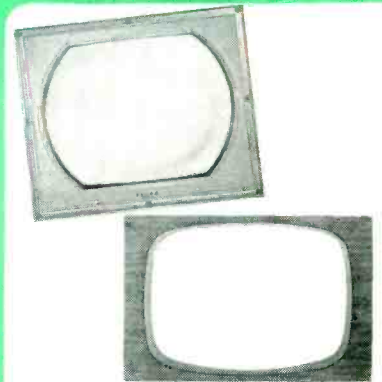

Custom Molded  
Plastic TV Lenses and Frames



Custom Injection Molded  
Plastic Knobs, Dials, Bezels,  
Name Plates, Coil Forms, etc.



### ***If your input problem is...***

- Unstable line voltage
- Ambient temperature from 0C to 40C
- Rapid line voltage changes
- Simultaneously varying line and load

If your input problem is smoothing out voltage supply fluctuations, look to 115-volt G-E stabilizers. Guarding a rated load at unity power factor, they maintain output within  $\pm 1\%$  against line variations from 95 to 130 volts. Quiet, automatic, they provide quick recovery when subject to simultaneous line and load variations, and voltage surges. Compact, lightweight G-E stabilizers do the job for you.

# **HOW TO give your product low-cost voltage control within $\pm 1\%$**



## **G-E Automatic Voltage Stabilizers**

For equipment that requires stable a-c input, look to General Electric voltage stabilizers for precision voltage control. For stable output of 115 or 230 volts in sizes from 15 to 5000 va, standard G-E stabilizers can be used to cut costs and to save space.

Why not investigate G-E stabilizers for an answer to your problem of voltage stabilization. For a modest investment, they go a long way toward decreasing your field calls, increasing customer satisfaction.

For details on G-E stabilizers, see your G-E specialist at your local G-E office, or write for booklet GEA-3634, *Apparatus Dept., General Electric Co., Schenectady 5, N.Y.*

### ***if your product is...***

If your product is composed of one of the following items that require voltage stability, it will pay you to investigate the advantages of G-E stabilizers.

- |                                  |  |
|----------------------------------|--|
| ● Television and radio equipment | ● Electrochemical apparatus              |
| ● Telephone apparatus            | ● Test equipment and precision processes |
| ● Sound equipment                | ● Photographic equipment                 |
| ● Lighting circuits              | ● Electronic circuits                    |
| ● Photometers                    | ● Calibration devices                    |
| ● X-ray equipment                | ● Color comparators                      |
| ● Rectifiers (full-wave)         |  |

# **GENERAL ELECTRIC**

411-83

**You can use**

# NORTH "Midget" RELAYS

**for "Man-Sized" jobs!**

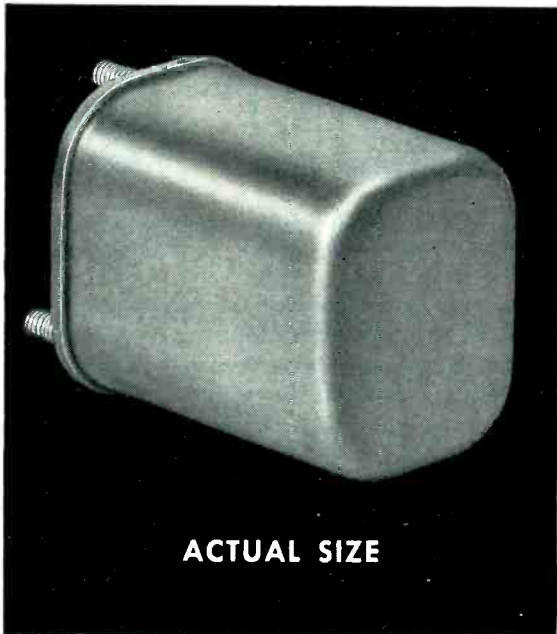

**ACTUAL SIZE**

Although we've been in the business since 1884, we've never made a relay that has a broader variety of application than our new line, known as "M-type". A typical example is the enclosed relay shown at left, which will be available either hermetically sealed or with snap-off dust cover.

This "Midget" will out-perform other relays of several times its weight and current consumption. (In normal use it draws .05 watts.) It has successfully met rigid Armed Forces tests from 71° C to -53° C, survived thirty-day humidity courses, vibration tests and dielectric breakdown tests at 500 volts. Wherever there's a tough, big-time relay job to be done, specify North M-type relays. Available in more than 70 combinations of make and break contacts in stock assembly.

The new North Relay Catalog describes the vast variety of relays made by North for every conceivable use, and this company's unmatched facilities for special relay engineering.

Write for a copy today

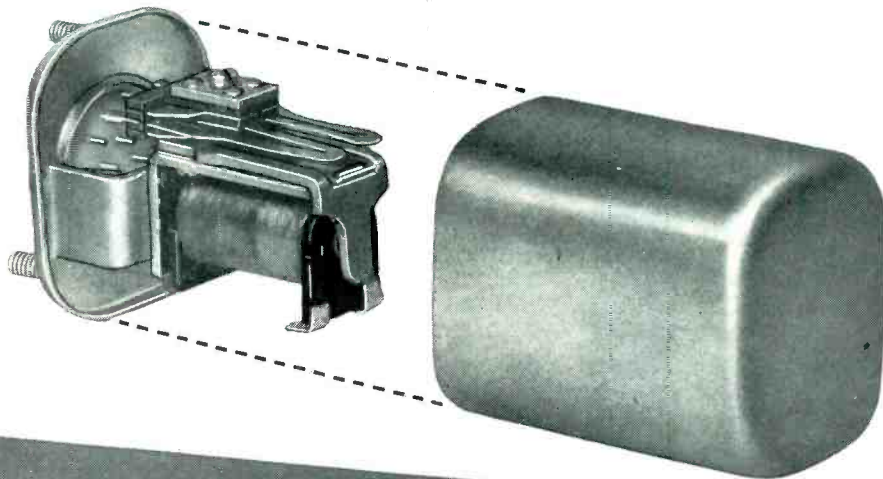

*Special Relays? Let North Engineer them for you!*

**THE NORTH ELECTRIC MANUFACTURING COMPANY**

*Originators of ALL RELAY Systems of Automatic Switching*

1438 T, South Market Street, Galion, Ohio, U.S.A.







TYPE ALA  
3 WATT

MAX. RES.  
25,000 ohms  
3/8" dia. 1 1/8" long



TYPE LL  
1/4 WATT

MAX. RES.  
0.2 Megohm  
5/8" dia. 1/4" long

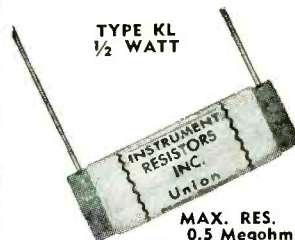

TYPE KL  
1/2 WATT

MAX. RES.  
0.5 Megohm  
3/8" dia. 1-3/16"  
long

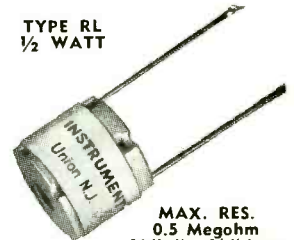

TYPE RL  
1/2 WATT

MAX. RES.  
0.5 Megohm  
1/2" dia. 1/2" long

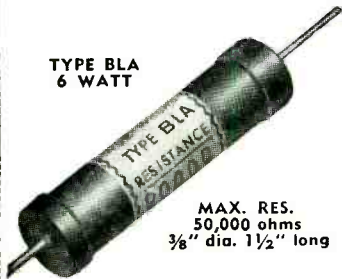

TYPE BLA  
6 WATT

MAX. RES.  
50,000 ohms  
3/8" dia. 1 1/2" long



TYPE WLA  
1 WATT  
INDUCTIVE\*

MAX. RESISTANCE  
331 Alloy 15,000 ohms  
Nichrome 8,000 ohms  
Manganin 2,500 ohms

BODY SIZE  
3/16" dia. 1" long

TOLERANCE  
Standard—1%

\*WLAN 3/8 (NON-INDUCTIVE)  
50% LOWER MAX. RES.



TYPE WLA  
3/8-1/2 WATT  
INDUCTIVE\*

MAX. RESISTANCE  
331 Alloy 7,500 ohms  
Nichrome 4,000 ohms  
Manganin 1,250 ohms

BODY SIZE  
3/16" dia. 3/8" long

TOLERANCE  
Standard—1%

\*WLAN 3/8 (NON-INDUCTIVE)  
50% LOWER MAX. RES.

### CUSTOM BUILT RESISTORS

INSTRUMENT RESISTORS COMPANY builds resistors to your specifications for special applications. All are produced to close tolerance to meet any unusual custom requirements. IN-RES-CO can supply wire-wound resistors in large or small quantity to practically any electrical and mechanical specification on short notice. Inquiries are invited and quotations will be supplied upon receipt of specifications and information regarding quantity desired.

# IN-RES-CO

## A COMPLETE LINE OF HIGH ACCURACY

IN-RES-CO high quality wire wound resistors are designed to meet the need of the Electronic and Instrumentation industries with dependable resistors of closer tolerances, proven performance and practical cost. Instrument Resistors Company, through constant expansion of its facilities and continuous modernization, keep pace with the wire wound resistor requirements of all phases of the electrical field. Consequently, the equipment manufacturer can obtain IN-RES-CO wire wound resistive components at prices fully reflecting the economy of mass production and built to a standard of quality that can only result from exclusive specialization in the manufacture of these products.

### IN-RES-CO TYPE IR WIRE WOUND RESISTORS



For use where space is at a premium! Combining midget size and extremely low cost with precision quality and performance.

#### IN-RES-CO TYPE

IR resistors meet all requirements

where precision resistance values and exceptionally small size must be satisfied at lowest possible cost. Although no larger than molded resistors, type IR units are wire-wound to a standard tolerance of  $\pm 1\%$  and maintain this accuracy throughout their life. They withstand rough usage and intermittent over-load in continuous service.

NICHROME is the trade mark of the Driver-Harris Company as registered at the U. S. Pat. Off.

Type	Max. Res.*	Max. Watts	Body Dia.	Body Length	Leads
IR-107	1900	1/8	7/64"	3/8"	.025" x 1-1/2"
IR-125	2500	1/4	1/8"	1/2"	.025" x 1-1/2"
IR-156	3500	1/2	5/32"	1/2"	.028" x 1-1/2"
IR-187	6000	1	3/16"	3/4"	.028" x 1-1/2"
IR-250	12000	2	1/4"	1"	.035" x 1-1/2"
IR-375	28000	5	3/8"	1-1/2"	.040" x 1-1/2"

\*Maximum resistance using .00135" dia. wire. Higher ohmic values can be furnished using smaller wire.

**TYPE SL  
1 WATT**

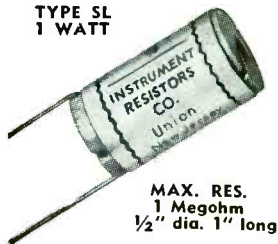

MAX. RES.  
1 Megohm  
1/2" dia. 1" long

**TYPE P-4  
1 WATT**



MAX. RES.  
1.0 Megohm  
9/16" dia. 1" long

**TYPE P-2  
1/2 WATT**



MAX. RES.  
300,000 ohms  
9/16" dia. 9/16" long

**TYPE RN  
NON-INDUCTIVE  
Tropi-Pruf**

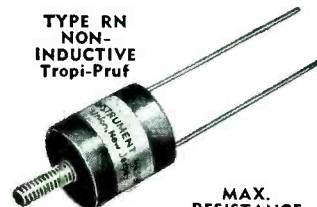

MAX. RESISTANCE  
331 Alloy 500,000 ohms  
Nichrome (R) 400,000 ohms  
Manganin 15,000 ohms  
TOLERANCE  
0.5% standard to 0.1% at slightly higher cost

**TYPE RX  
NON-INDUCTIVE  
Tropi-Pruf**



MAX. RESISTANCE  
331 Alloy 500,000 ohms  
Nichrome (R) 350,000 ohms  
Manganin 30,000 ohms  
TOLERANCE  
0.5% standard to 0.1% at slightly higher cost

**TYPE CX  
1/2 WATT  
Non-Inductive**



MAX. RESISTANCE  
331 Alloy 750,000 ohms  
Nichrome 500,000 ohms  
Manganin 15,000 ohms

BODY SIZE  
9/16" dia. 3/8" long  
TOLERANCES  
Standard—1%  
SPECIAL—TO 1/10%

**TYPE BX  
1 WATT  
NON-INDUCTIVE**



MAX. RESISTANCE  
331 Alloy 1.5 Megohm  
Nichrome 1.0 Megohm  
Manganin 30,000 ohms

BODY SIZE  
9/16" dia. 1" long  
TOLERANCES  
Standard—1%  
SPECIAL—TO 1/10%

**RF CHOKE COILS**

INSTRUMENT RESISTORS COMPANY specializes in the manufacture of RF choke coils wound to any specified inductance and Q value. Coils in this category are precision wound on ultra-modern winding equipment that insures finest product quality at lowest cost. IN-RES-CO is equipped to supply units of these types or others, including hermetically sealed units, in large or small quantity to exact specification. For prompt quotation on your requirements, call or write outlining specifications and quantity.

# APPLICATION-DESIGNED WIRE WOUND RESISTORS

## RESISTIVE COMPONENTS FOR EVERY NEED

IN-RES-CO wire wound resistors offer the circuit designer a new opportunity to meet increasingly critical requirements. The IN-RES-CO line is complete—resistance ranges from .01 ohm to several megohms; power ratings from a fraction of a watt to 10 watts. Special units are included for counteracting high humidity, fungus, space limitations, temperature rise, etc. Units can be supplied either inductive or non-inductive, wound with Nichrome, Manganin or 331 Alloy. For complete data, send for the new IN-RES-CO catalog.



*of particular importance now!*

### A COMPLETE LINE OF IN-RES-CO MINIATURE and SUB-MINIATURE RESISTORS

A complete line of resistors specially designed for inclusion in miniaturized equipment and component designs. Ideally suited for all applications requiring resistive units of extremely compact size and high dependability. Available in types and sizes that meet practically every application need. Available to close tolerance and in high resistance values, yet small enough to meet limited space requirements of the most compact equipment. For complete information call or write today, or consult the latest IN-RES-CO catalog.

## INSTRUMENT RESISTORS COMPANY

1036 COMMERCE AVENUE  UNION, NEW JERSEY

MANUFACTURERS OF WIRE WOUND RESISTORS FOR EVERY ELECTRICAL AND ELECTRONIC NEED



PACKAGED Functional Electronics

# Components for Control Systems

*mecha* products

Servomechanisms Inc. designs, engineers and manufactures electronic control devices for military and commercial applications.

These devices are composed of a number of functional electronic units, which are miniaturized and packaged as plug-in components.

Control equipment is readily synthesized from these small component packages which solve the important system requirements of:

- *Spatial adaptability*
- *Instant maintainability*
- *Training simplicity*
- *Ease of manufacture*

**SERVOMECHANISMS**  
inc.\*

Old Country & Glen Cove Roads, Mineola, N. Y.

Imperial Hway. & Sepulveda Blvd., Los Angeles, Calif.

\*Trademark

*Announcing*

**GLASSEAL**

REG. TRADE MARK



ACTUAL  
SIZE

**HERMETICALLY-  
SEALED**

*Miniature*

**TUBULAR PAPER CAPACITORS by**

**PYRAMID**

**Pyramid Type PG "GLASSEAL"** miniature paper capacitors are assembled in metal tubes with glass-metal terminals. They will fully meet the most exacting demands of high vacuum, high pressure, temperature cycling, immersion cycling and corrosion tests.

**TEMPERATURE  
RANGES: -55° to +125°C.**

**CAPACITANCE  
RANGE: .001 mfd. to 1.0 mfd.**

**VOLTAGE RANGE: 100 to 600  
v.d.c. operating**

*Your inquiries are invited*



**PYRAMID Electric Company**

GENERAL OFFICES and PLANT NO. 1  
1445 HUDSON BLVD. • NORTH BERGEN, N. J.

PLANT NO. 2  
155 OXFORD ST. • PATERSON, N. J.

VISIT OUR BOOTH NO. 208 AT THE IRE CONVENTION



# new!



ACTUAL  
SIZE

## PYRAMID TINY TYPE 85LPT TUBULAR PAPER CAPACITORS

**Fit anywhere!**

**Suitable for  
85°C. operation!**

**CAPACITANCE RANGE:**  
.0001 TO .5 MFD.

**VOLTAGE RANGE:**  
200 TO 600 V., INCLUSIVE

**Sturdily built in phenolic-  
impregnated tubes. Ends  
are plastic-sealed.**

**WRITE FOR COMPLETE LITERATURE**  
Representatives and Distributors  
Throughout the U.S.A. and Canada



## PYRAMID

**PYRAMID ELECTRIC COMPANY**

1445 Hudson Boulevard  
North Bergen, N. J., U. S. A.

TELEGRAMS: WUX North Bergen, N. J.  
CABLE ADDRESS: Pyramidusa

# BUSINESS BRIEFS

By W. W. MacDONALD

"If Russia Strikes, this will be primarily an electronics war, in which type of conflict our country can show to best advantage. Science covers a multitude of fields. To single out any particular one for emphasis may seem out of place. However, in this world crisis, it is realistic to single out the field of electronics as of special importance.

"Electronics includes radar, automatic sighting for fire power, guided missiles, defense against the submarine and automatic controls of countless kinds. In World War II, electronics had a sensational start but did not get far beyond an infant industry. Numerous postwar applications came along, the best known being television. Now a great new stimulus will come from the defense program, and as a result, electronics will emerge as a mature industry. The permanent, peacetime significance for all American industry will be great.

"Statistical estimates of war orders in electronics are difficult to make. . . . The best judgment at the moment is that the value of electronic equipment per man in uniform will be at least three to four times as great as that in the last war. Quite possibly this ratio may have to be revised upward as the events of 1952 and 1953 unfold."—Economist *Lionel D. Edie*

"The Impact of rapidly increasing national defense orders has so far been felt only (largely) in the acceleration of current military production and expansion of research and development work. Volume of sales to the armed services has not yet increased (much)."

So says Charles F. Adams, Jr. of Raytheon in a statement to stockholders. Words in parentheses are ours and, with this much latitude, the statement represents a fair picture of the extent to which the mobilization program has affected most manufacturers in the field of electronics at this writing.

**Late January Meeting** of the Electronics Equipment Industry Advisory Committee with Munitions Board and military officials at the Pentagon highlighted problems businessmen on the one hand and government men on the other are trying to solve by mutual cooperation.

Industry spokesmen emphasized the necessity for speeding up the placement of orders to preserve engineering personnel and labor forces, suggested closer coordination by the various services, urged faster contracting procedures and the development of programs to establish more subcontracting supply sources.

Government spokesmen said every effort is being made to spread procurement over a larger number of plants, emphasized that negotiation of contracts rather than the competitive bid system could now be widely used to speed up placement of orders, said that money on hand was not enough to avoid all dislocation during the conversion from civilian to military manufacturing but soon might be.

**Munitions Board Electronics Equipment Industry Advisory Committee** consists of the following men:

B. Abrams, *Emerson*  
W. R. G. Baker, *GE*  
M. F. Balcom, *Sylvania*  
A. A. Berard, *Ward-Leonard*  
E. W. Butler, *Federal Tel.*  
R. W. Carter, *Carter Motor*  
M. Cohen, *Sickles*  
A. Crossley, *Electro Prod.*  
R. O. Driver, *Wilbur B. Driver*  
H. A. Bhle, *IRC*  
R. C. Ellis, *Raytheon*  
W. Evans, *Westinghouse*  
F. M. Folsom, *RCA*  
P. V. Galvin, *Motorola*  
G. M. Gardner, *Wells-Gardner*  
R. A. Graver, *Admiral*  
W. J. Halligan, *Hallcrafters*  
R. F. Herr, *Philco*  
E. K. Foster, *Bendix*  
A. P. Hirsch, *Micamold*  
H. L. Hoffman, *Hoffman Radio*  
J. J. Kahn, *Standard Trans.*  
J. Kruesi, *American Lava*  
F. R. Lack, *WE*  
W. A. MacDonald, *Hazeltine*  
T. Meloy, *Melpar*  
H. L. Olesen, *Weston*  
A. D. Plamondon, Jr., *Indiana Steel*  
R. C. Sprague, *Sprague Elec.*  
A. E. Thiessen, *GR*  
C. A. Warden, Jr., *Superior Tube*  
G. E. Wright, *Bliley*

**Manpower** is already critical in our highly specialized technical

# This "brain" can stump a thousand experts



Hundreds of Sylvania Germanium Diodes simulate the synapses of the human brain, giving the machine the ability to compute, make comparisons and form decisions based on those comparisons.

## SYLVANIA Germanium Diodes speed "thinking processes" of the new compact MADDIDA\* Computer

This latest electronic computer, made by Northrop Aircraft Inc., is smaller than an average desk, yet it can surpass the efforts of a thousand expert mathematicians.

In a few seconds, the machine can solve complex problems requiring months or even years on standard desk calculating equipment.

Contributing to the amazing speed and to the compactness of this machine are several hundred Sylvania Germanium Diodes. Set snugly in short rows, these diodes actually function as ultra-high speed relays, shunting strings of numbers or instructions about among the vacuum tubes.

The small size of Sylvania diodes also permits compact packaging and worthwhile economies in design cost while assuring maximum efficiency of operation.

Let us acquaint you with some of the other important uses for Sylvania Germanium Diodes. Perhaps they can help you solve cost or design problems. For detailed data concerning the complete line of Sylvania Germanium Diodes, mail the coupon TODAY!

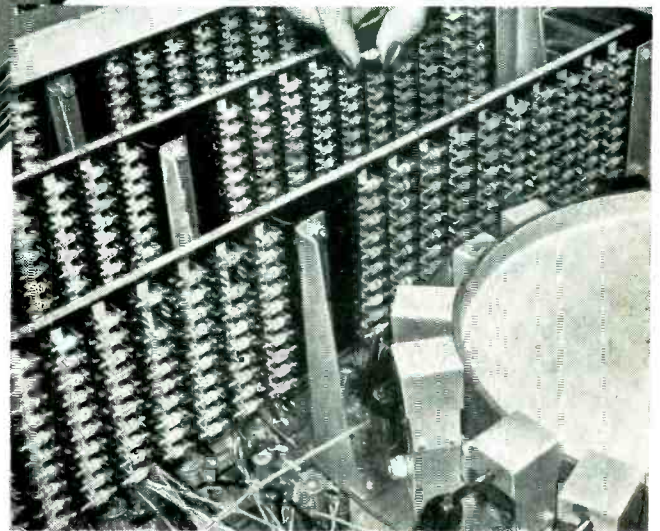

\*The name MADDIDA is derived from "Magnetic Drum Digital Differential Analyzer."

Sylvania Electric Products Inc.  
Dept. E-1003, Emporium, Pa.

Please send me your new 8 page catalog listing characteristics of all Sylvania Germanium Diodes.

Name \_\_\_\_\_  
Street \_\_\_\_\_  
City \_\_\_\_\_ Zone \_\_\_\_\_ State \_\_\_\_\_



# SYLVANIA ELECTRIC

FLUORESCENT TUBES; FIXTURES; SIGN TUBING; WIRING DEVICES; LIGHT BULBS; RADIO TUBES; TELEVISION PICTURE TUBES; ELECTRONIC PRODUCTS; ELECTRONIC TEST EQUIPMENT; PHOTOLAMPS; TELEVISION SETS



## SMALL Air-damped BARRYMOUNTS

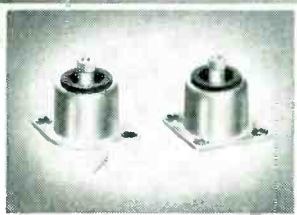
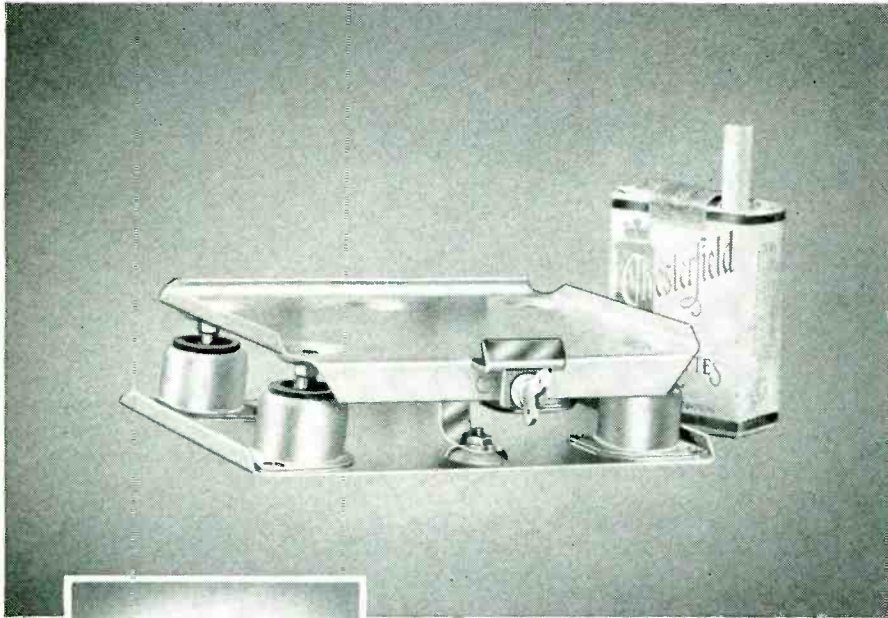

### meet your MINIATURIZATION needs in VIBRATION ISOLATION

These new compact, air-damped BARRYMOUNTS are designed especially for mounting small, light-weight apparatus and instruments. Each unit mount occupies only about one cubic inch and weighs 5/16 ounce. Load ratings are from 0.1 to 3.0 pounds. Two-hole and four-hole mountings are available.

**Mounting bases assembled with these unit Barrymounts, can be furnished to your specifications for dimensions and load ratings; a typical instrument mounting base is shown above.**

**FREE DATA SHEET #606** gives details of sizes and performance characteristics of Series 6465 and 6690 BARRYMOUNTS. Ask also for Catalog 502 describing other BARRYMOUNTS for aircraft service, and for Catalog 509 covering ALL-METL Barrymounts for unusual airborne applications at extremes of temperature.



## THE BARRY CORP.

Main Office 707 Pleasant St. ● Watertown 72, Massachusetts

New York Rochester Philadelphia Washington Cleveland Dayton Detroit  
Chicago Minneapolis St. Louis Seattle Los Angeles Dallas Toronto

field. At the top of the Air Force's list of 18 types of officers most needed in the current expansion program is the word "electronics"; radar and radar maintenance heads the list of 8 needed types of airmen.

Unconfirmed but plausible is the rumor that a well-established firm in our field has offered to hire all electronic engineers in the graduating class of a western university. And that another firm, not so well established, is attempting to hire several hundred electronic engineers in the hope that if they can get engineers they can get government business.

Civilian Defense, not yet cohesive on a national, state or city basis insofar as communications is concerned, appears to wait upon assignment of radio frequencies linking at least two of the three levels of government together in the event wires go down. Action re amateurs (p 148) is just one necessary step.

A Federal Civilian Defense Administration committee says no instruments suitable for high-intensity radiation measurements immediately after an atomic attack are presently available. Low-intensity measurements can, however, be made in the weeks that follow such an attack by means of existing instruments.

Sale of 2-meter transmitters and receivers to people who are not amateurs indicates a new market for emergency communications gear. Similarly, a civilian defense market is developing for electronic megaphones.

Korean Night Attacks have renewed the interest of our military men in infrared detection apparatus such as the "sniperscopes" and "snooperscopes" employed with considerable success at Okinawa in the last war. Look for new development and production contracts in this field in the near future. And increased demand for the special batteries involved.

Along the same lines, we hear that conventional electronic hearing aids have considerable virtue in detecting the presence of infiltrating forces. Minor modifica-

tion of design could greatly increase military effectiveness.

**Test Equipment** and maintenance procedures must be developed in step with new military electronic equipment or such equipment will be limited in its effectiveness. This is the warning of E. U. Condon of the National Bureau of Standards, who points out that in World War II many radar sets operated for extended periods at half their potential range.

**Critical Materials** are, we understand, conserved in a still experimental Philco television receiver design that makes wider use of selenium rectifiers, voltage doublers and new circuits, especially for synchronizing and deflection.

More detail later in, we hope, our feature pages.

**Transistors**, according to a report just released by the Department of Commerce, may achieve their first big-time volume in the trigger circuits of digital computers.

**More Than 4,000,000** radiotelephone contacts with pilots in flight were made by CAA aircraft communicators in the first eight months of 1950, an increase of 224 percent over the similar period in 1949.

**IBM**, maker of business machines, has just used its 2,313-126th electron tube.

**A British Subscriber** has just secured an American patent covering a new type of connector which appears to be unique in that both parts are identical, facilitating interchangeability. He wants to contact interested manufacturers.

We'll be glad to provide the introduction.

**TV Therapy** is, according to officials of a Pennsylvania hospital, helping bring mildly psychopathic patients back to normal.

And in some cases, we hasten to add, vice versa.



# Improved TYPE 6 SENSITIVE CONTACTOR

A polarized magnetic structure with switching up to 4 pole 2 throw, or 4 pole 3 positions; 5 ampere nominal contact rating.

**3 WAY**

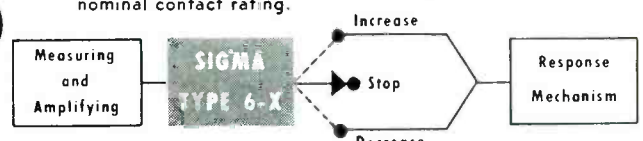

For POSITIONING, REMOTE CONTROLLING (as in servos) and TELEMETERING. When conditions are "normal", armature is forcibly maintained in a balanced condition, all circuits open.

**2 WAY**

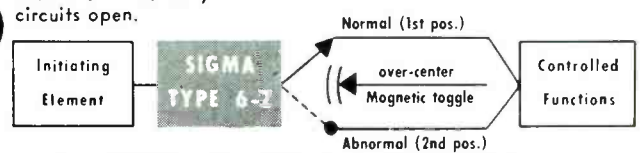

For SWITCHING, OVERLOAD PROTECTION, etc. Momentary Signal as from push button or circuit overload trips relay, which remains "Latched" until electrically reset.

First announced in 1946 as a new development in magnetic switching, the Sigma Type 6 has become established as (1) an excellent output device for many types of servo amplifier; (2) one of the best available latching relays where ruggedness, resistance to shock and vibration and long life are important; (3) probably the only contactor of comparable switch capacity with 50 milliwatt sensitivity (or better, with less than 4 poles). In the process of exploiting these possibilities, however, as with any new product, many minor defects or "bugs" came to light. There were types of instability, distortion of frame under some kinds of shock, and areas where inadequate precision in manufacture was evident. In eliminating these "bugs", details, tolerances, processes and techniques have been reengineered throughout, and the present product has consistent and uniform properties.

**SIGMA** Instruments, Inc.  
**SENSITIVE RELAYS**

62 Ceylon St., Boston 21, Mass.



**Service  
Beyond  
Expectations!**

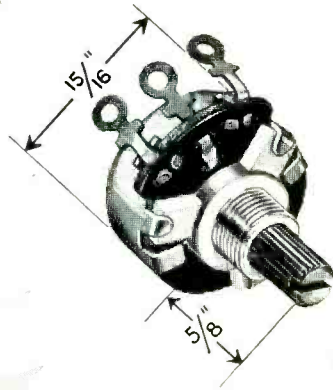

## New Development In Mallory Midgetrol\* Minimizes TV Drift!

### THE 15/16" MALLORY MIDGETROL

(Power rating 1/2 watt)

Electrical characteristics specially designed for critical applications in television, radio and other circuits. Insulated shafts are knurled for ease in adjustment. Current-carrying parts provide 1500 volt insulation... 15/16" diameter saves space. Precision-controlled carbon element provides smooth tapers, quiet operation, accurate resistance values, less drift in television applications.

\*Trade Mark

The Mallory Midgetrol now embodies a new technique in variable resistor manufacture . . . providing precise control of drift under high humidity conditions. It involves a new treatment of the carbon element, assuring uniform dispersion of talcum-fine particles over a special phenolic base with an extremely low factor of moisture absorption. As a result, drift is held within very close limits... well within the requirements for TV picture stability. *This feature will obviously eliminate a troublesome source of field service problems.* It is an important addition to the desirable characteristics described at the left.

*That's service beyond expectations!*

Mallory's electronic component know-how is at your disposal. What Mallory has done for others can be done for you!

Television Tuners, Special Switches, Controls and Resistors

**P. R. MALLORY & CO., Inc.**  
**MALLORY**

**P. R. MALLORY & CO., Inc., INDIANAPOLIS 6, INDIANA**

#### SERVING INDUSTRY WITH

Electromechanical Products  
*Resistors*      *Switches*  
*TV Tuners*      *Vibrators*

Electrochemical Products  
*Capacitors*      *Rectifiers*  
*Mercury Dry Batteries*

Metallurgical Products  
*Contacts*      *Special Metals*  
*Welding Materials*



# CROSS TALK

► **M=MMM** . . . Mobilization of our war resources involves men, materials and machines. So far as the electronics industry is concerned the recent news in these departments is, respectively, bad, good and fair. The manpower situation is bad. If we are to absorb the 5-to-10-billion-dollar annual load of military production that is now on paper, our most serious shortage is trained technical manpower. In the face of this certain fact, we find students in engineering colleges deserting their studies and enlisting in droves to escape service as foot-soldiers in favor of service as airmen or sailors. A belated promise to permit choice of service, after completion of the current college year arrested, but did not stop, this exodus. It should be stopped entirely and quickly. We need an enlightened program of student deferment (the Hershey plan makes sense to us). But we need it now, not after we lose a year's supply of young engineers.

The materials situation, as we see it, is good. Domestic production must be cut back, due to lack of materials. This is inevitable; the only danger is that it may be cut back too soon and interrupt the flow of production. This danger seems much less likely in view of the recent action by the National Production Authority in avoiding a shut-down in the RCA Harrison plant. Industry and government seem to be working well together on this aspect. Industry has to have a well-documented story, and no nonsense. But granted a little

hard work in getting convincing facts together, relief can be obtained. Amen!

As to machinery, fair is the word. We have a vastly expanded plant capacity in this business of ours, based almost entirely on peacetime production of television sets. To the extent that this capacity can be used, we are in good shape. But to the extent that special items must be made for new military designs, we are in poor shape. It takes a year and a half to build a plant for making subminiature tubes, and millions of dollars on the line. If the predicted military consumption of subminiatures materializes, we'll need at least one such new plant, maybe more, before 18 months are up. But official action on new plant construction is slow. If we start now, we can meet the demand. Start we must!

► **SEQUENTANEOUS** . . . Looks like a new term is needed to describe color television systems. Time was when the systems were separate and distinct: CTI, CBS and RCA were sequential, by lines, fields and dots, respectively. The 1946 three-channel RCA system and the 1950 GE (Dome) system were simultaneous. But now the sharp lines are being broken down. Largely as a result of the Hazeltine work on the RCA dot-sequential system, it has been realized that the RCA system is in fact a simultaneous system, not only in the by-passed monochrome portion of the system, but also in the interspersed color signals. In fact, it appears that the difference be-

tween the GE and RCA systems lies largely in the terminal apparatus, not in the principle of spectrum utilization. It is, in fact, easy to show that the color signals in the dot-sequential system are present continuously and simultaneously and that the dot-sequential pattern is merely a form of interference between the separate carriers. Professor Everitt reminds us that the CBS system can also be considered simultaneous, in which each of the continuously-present color carriers cancels out in two fields out of three. Many think that this latter concept is stretching things, and there certainly is a difference in the manner in which the systems can be used practically. A lot of thought is needed to straighten out the concepts. Pending a definitive statement of what system does what and how, we're disposed to call the whole bunch of 'em simulquential systems.

► **EXAGGERATED** . . . As we shall announce in more detail in a later issue, the staff of this journal is currently engaged in a monumental indexing effort which has led us to examine critically the indexes of other periodicals. To our surprise, looking over the 1950 index of the *Proceedings of the IRE*, we came across this entry:

*Obituaries:* Zworykin, Vladimir K., April, p. 447. A hurried check in the April issue reassured us; Dr. Zworykin's demise had been slightly exaggerated. He had, rather, been inducted into Eta Kappa Nu.



# Latest Developments

New laboratory experiments are outlined. Circuit of a practical generator is given. A short-range portable communication device using a xylene-filled tank for ultrasonic diffraction is also described

By **ARTHUR R. LAUFER**

*Assistant Professor  
University of Missouri  
Columbia, Mo.*

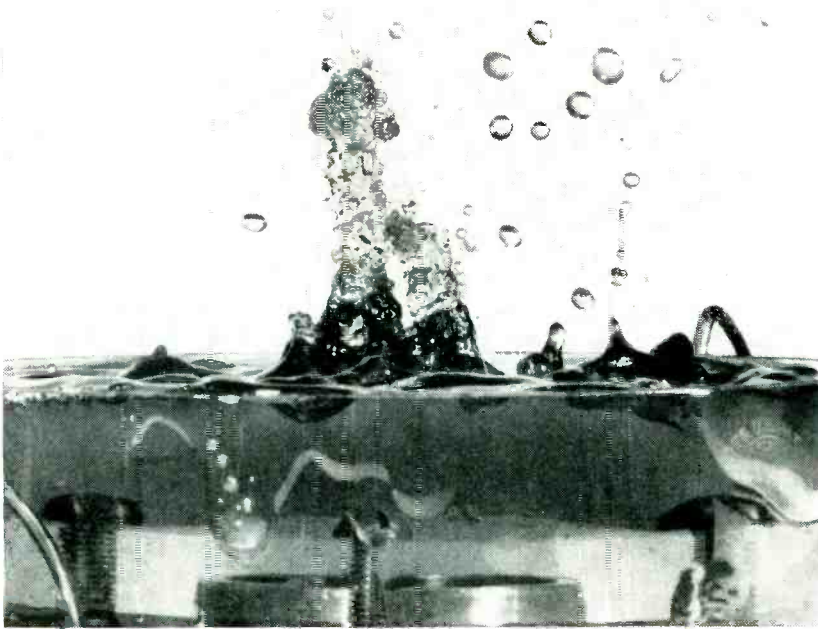

Vertical beam of ultrasonic energy radiated upward through a liquid raises a mound of liquid several inches above the surface level and shoots droplets out to greater heights

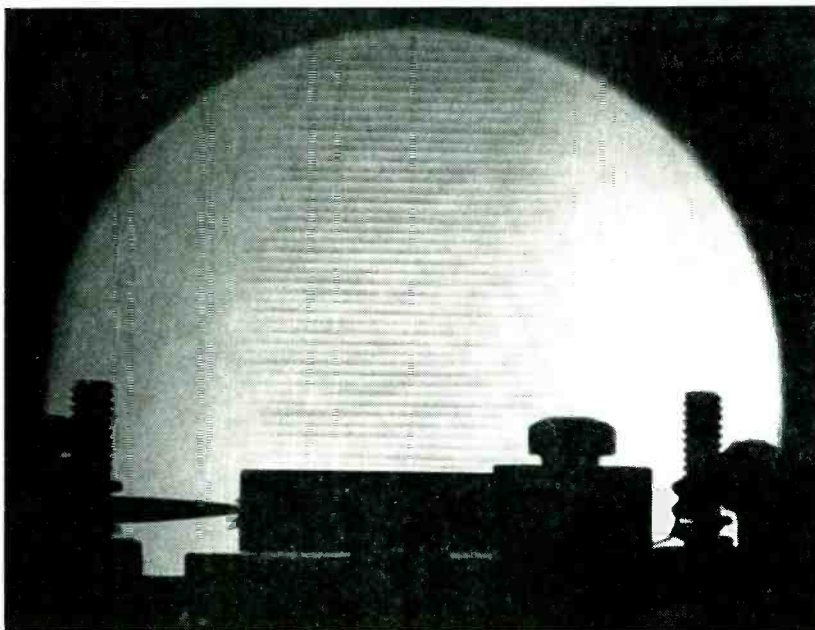

Photograph of plane-parallel regions of compression and expansion in air above a vibrating quartz crystal, taken by I. F. Zarimann

**P**HENOMENA associated with intense ultrasonic waves are no longer scientific curiosities and have been put to a variety of applications. Among recent patents is one for a washing machine using ultrasonic agitation to launder clothes.

Ultrasonic energy has been used to produce alloys of metals which are not ordinarily miscible. A new soldering iron uses ultrasonic vibrations to destroy refractory oxide film and permit soldering aluminum without flux. Sterilization of foods and coagulation of aerosols such as mist and smoke are subjects of ultrasonic investigation.

Waves generated by a circular piston source vibrating at audible frequencies spread out from the source in all directions and will bend around corners. At higher frequencies the waves assume directional characteristics with more of the wave energy propagated in certain directions than others and with less bending. At very high frequencies the energy is concentrated in a cone whose angle becomes smaller as the ratio of wavelength to diameter of the piston source decreases. Such short waves are propagated essentially in a given direction with negligible bending.

Concentration of ultrasonic energy into a cone makes it possible to produce beams of high intensity, defined as the energy passing through a unit area per unit time. Within the past few years ultrasonic sources have been built with outputs of 50 watts of acoustical power per square cm and beams of radiation have been focused to yield





and a higher cost. Most of the manufacturers of standard radio crystals also provide ultrasonic quartzes ground to the desired frequency and plated with metal electrodes on both major surfaces.

A one megacycle circular X-cut quartz of 1½-in. diameter, such as that shown in the foreground of Fig. 3, retails for about fifteen dollars and is adequate for most of the experiments to be described. For the optical experiments a 5-mc crystal is preferable and can be purchased at even lower cost.

Two of the many possible forms of crystal holders are illustrated in Fig. 3 and 4. In the simple form of Fig. 3 the crystal rests on a brass plate serving as the lower electrode. The upper electrode, a one-mil copper foil, is supported and pressed lightly against the quartz by a wire which is itself supported by a stand-off insulator mounted on a brass plate. In order to minimize sparking between the electrodes, the transducer rests in a dish of xylene, carbon tetrachloride or some other liquid of high dielectric strength. When the high-frequency voltage is applied to the electrodes, the vibrating quartz sends a beam of ultrasonic waves vertically upward through the liquid medium.

The more advanced form of crystal holder of Fig. 4, shown in cross-section in Fig. 5, is so designed that the useful ultrasonic output of the crystal is greatly enhanced. The quartz is mounted between two hollow brass cylinders which make

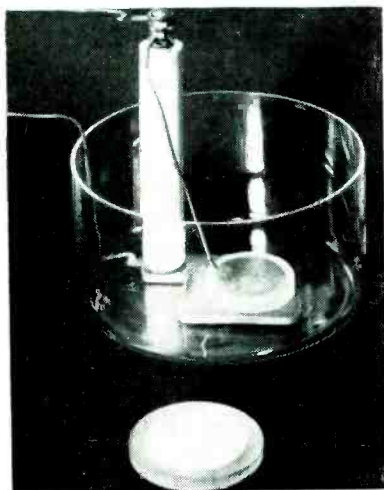

FIG. 3—Simple crystal holder, with 1-mc circular X-cut quartz crystal of 1½-in. diameter shown in foreground

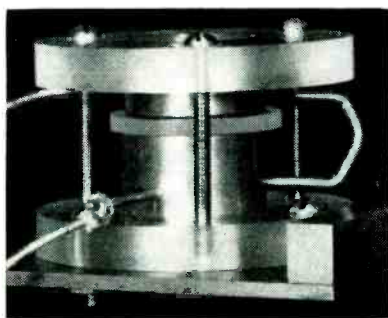

FIG. 4—Improved crystal holder which allows higher energy output because of reduced voltage gradients and air backing

electrical contact with the electrode platings on the crystal. The edges of the cylinders are rounded to reduce the large voltage gradients associated with the edges of the thin platings themselves. Higher voltages can be applied to the electrodes and the ultrasonic energy output proportional to the square of the voltage is increased. The useful energy output is also increased by the air backing for the crystal.

#### Energy Considerations

Little ultrasonic energy is radiated into air by the quartz as a consequence of the great difference in acoustic impedance (density  $\times$  sound velocity) of the two media, whereas in the simpler form of holder an appreciable amount of energy is lost to the brass plate. Energy radiated upward into the dielectric liquid surrounding the holder and through the hole in the Plexiglas disk is thereby materially increased. A safety spark gap is employed to protect the crystal and the entire crystal holder is mounted on a brass plate.

If the crystal is excited at its resonant frequency and held in such a position that a vertical beam of ultrasonic energy is radiated upward through the liquid, the magnitude of energy in the beam can be visually demonstrated. At the liquid surface the ultrasonic beam raises a mound of liquid several inches above the level in the dish and droplets are shot out of the mound to far greater heights. Intensity of vibration in the liquid is so great that alternating pressure amplitudes as high as a thousand atmospheres and particle accelera-

tions as high as a million times the acceleration of gravity can be achieved. This energy can be employed to produce a variety of interesting effects.

#### Laboratory Experiments

If the stem of a broken wine glass is held in the vibrating mound with the base of the glass upward and a fine powder such as lycopodium is sprinkled on the disk-like base, the powder will form a beautiful system of concentric circular rings delineating the nodal lines in the pattern of vibration of the base. A similar effect can be obtained by merely dusting the inner surface of a champagne glass with the powder. The ring system will appear when the base of the glass is touched to the mound.

If the closed end of a glass tube about a foot long and half an inch in diameter and coated inside with a layer of heavy oil is dipped into the mound the oil gathers itself into rings a millimeter or two apart, lining the tube from top to bottom.

A tapering glass rod, half a millimeter in diameter at the tip, with its butt immersed in the mound, transmits vibrations of such intensity that the rod will burn its way rapidly through a chip of wood. Heating is the result of friction and occurs only at the point of contact. The remainder of the rod feels quite cool to the touch but if it is squeezed, the frictional heating at points of contact with the fingers makes the rod feel too hot to hold.

For certain experiments it is necessary to conduct the ultrasonic energy from the mound into another liquid. A suitable container for the liquid can be made of a glass tube about an inch in diameter by cementing a thin disk of celluloid across one end to form the bottom of the container. If the base of this container is now held in the mound, its contents will be irradiated or "sonized" by the ultrasonic beam.

Candle wax and water are normally immiscible, but if a small amount of candle wax is melted and allowed to drip and solidify on the surface of water in a container and if the water is sonized, a rapid dispersion of the wax in the water will take place and yield a white suspension of unusual permanence. This

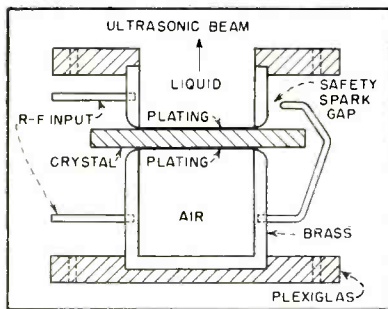

FIG. 5—Cross-sectional view of improved crystal holder, showing design details and materials used

experiment can be repeated with oil instead of wax and, similarly, the violent agitation will throw the oil down as a fine white cloud to form an emulsion of oil in water. A little mercury at the bottom of the container, with water above it, will be thrown up into suspension in the water when sonized. The water first becomes milky in appearance, then brown, and finally black.

If a volatile liquid such as benzol is sonized, another interesting effect can be observed. The ultrasonic energy throws up innumerable minute droplets to form a smoky white benzol fog with its surface in tumultuous motion, much like the cloud of fine spray projected upward by the shock wave from an underwater explosion of a depth charge.

If water containing an ice cube is sonized for a minute or two and then the cube is squeezed between thumb and fingers, it will break into small fragments, showing that internal liquefaction has taken place throughout the mass, an effect similar to the production of "rotten ice" by exposure to the sun.

Biological specimens are strongly affected by ultrasonic irradiation. Red blood corpuscles are quickly destroyed when suspended in water and sonized. The turbid mixture of blood and water becomes as clear as a solution of red aniline dye. Insects, small fish and frogs held under water and sonized are killed within a minute or two. Small forms of animal life such as *Daphnia* are also rapidly put to death and torn to shreds by the intense sound energy.

#### Low-Power Effects

Effects somewhat similar to those described can be achieved with a low-power generator if steps are

taken to focus the ultrasonic beam. The low-power electronic oscillator may be built using the same circuit discussed previously with components of lower voltage and current ratings. An oscillator supplying the crystal with about twenty watts of r-f power at several hundred volts will give adequate performance. The ultrasonic beam can be focused with an ordinary watch glass. The concave surface of the watch glass, which may be about two inches in diameter, should be held in the beam so as to reflect the ultrasonic energy vertically upward toward the liquid surface. If the liquid level is adjusted to be exactly at the focus of the reflector, the liquid will be ejected from the surface in a thin stream rising high in the air and, at the same time, a dense fog will be produced.

#### Ultrasonic Heating

If the beam is focused on the surface of a piece of rubber or Plexiglas in the body of the liquid, the intense heating will produce small blisters on the surface and the material will have the characteristic odor of overheating when removed. Under the same circumstances a block of wax will melt in such a way as to show the conical focusing of the beam inside the block.

The low-power generator is particularly suited for demonstration of certain optical phenomena associated with ultrasonics. For the observation of these effects the crystal holder should be placed at one end of a rectangular tank, so that a

horizontal beam of ultrasonic waves can be propagated along the length.

The long sides of the tank should be of plate glass and the tank should be filled with an optically transparent liquid of high dielectric strength. The end of the tank toward which the beam is directed should be covered with a pad of rubber to absorb the sound energy and therefore to prevent reflection of the beam.

#### Ultrasonic Diffraction

When ultrasonic waves traverse a liquid alternate regions of compression and expansion are produced parallel to the crystal surface corresponding, respectively, to regions of increased and decreased optical density. The closely spaced density variations act somewhat as the opaque and transparent regions or lines of a ruled optical-diffraction grating and serve to diffract light passing through the glass sides of the tank.

Optical arrangement for the observation of the diffraction of light by ultrasonic waves is shown in Fig. 6. A pair of condensing lenses brings the light from a lamp to a focus on a small hole in an opaque diaphragm with the illuminated hole then serving as the light source. The hole is situated at the principal focus of a large-diameter lens which renders the light parallel and sends it through the tank in a direction perpendicular to the path of the ultrasonic waves.

The beam of light is gathered by another large-diameter lens and brought to a focus, at which point

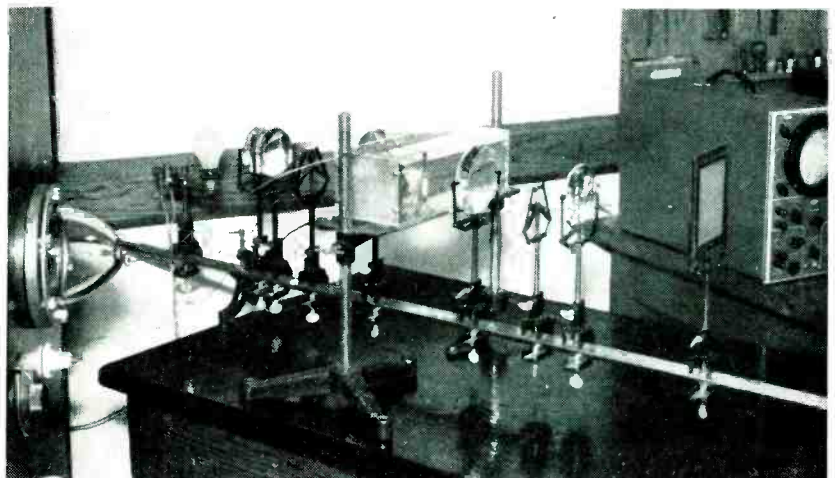

FIG. 6—Optical setup for observation of diffraction of light by ultrasonic waves



an opaque stop is inserted. The stop consists of a small spot of india ink on a strip of glass and serves to block the light beam when there are no ultrasonic waves in the tank. If voltage is applied to the crystal electrodes, however, the ultrasonic waves in the liquid diffract or bend the light out of its normal course so that it can pass around the stop and reach still another lens. This latter lens is so placed that it can produce an image of the median plane of the tank on a ground-glass screen.

This method of ultrasonic light diffraction was used by G. W. Willard of the Bell Telephone Laboratories to obtain the photographs reproduced in Fig. 7 and 8. Figure 7 (top photo) shows the beam generated by the quartz crystal at the left and absorbed in the rubber pad at the right after traversing the length of the tank. In the middle

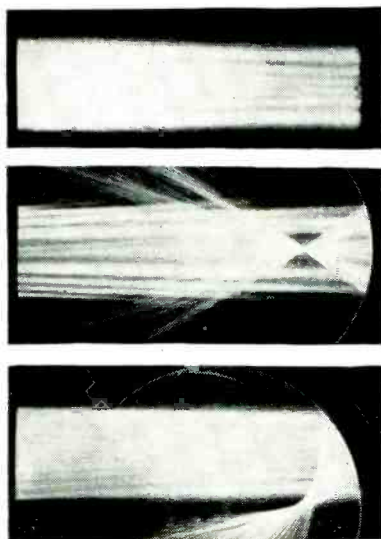

FIG. 7—Focusing of ultrasonic beams generated by crystal at left and absorbed in rubber pad at the right, as accomplished by G. W. Willard of Bell Telephone Laboratories

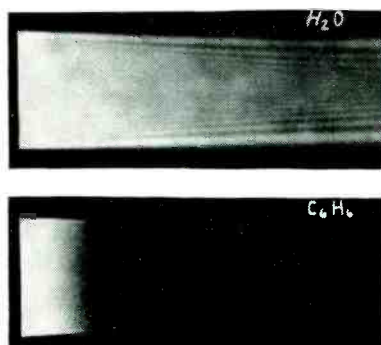

FIG. 8—Difference in attenuation of ultrasonic waves in different liquids

photo the beam is centered along the principal axis of a concave cylindrical brass reflector which converges the light to a sharp focus. The beam in the bottom photo is incident upon the same reflector but not along its principal axis, and the well-known effect of spherical aberration is clearly evidenced by the poor focus.

The great difference in absorption or attenuation of ultrasonic waves in different liquids is illustrated in Fig. 8. The upper photograph indicates that there is but slight absorption in water whereas the lower photograph shows that the ultrasonic beam is completely absorbed after traversing only a short distance in benzene.

### Diffraction Applications

Not only is the diffraction of light by ultrasonics used in physical and chemical research, but it is also used in the light-modulating element in the British Scophony tv system and in a short-range communication device developed for military use.

These applications depend on the fact that the amount of light diffracted out of the zero order (undeflected) image formed by the lenses can be changed by merely changing the amplitude of the ultrasonic waves, that is, by changing the magnitude of the voltage applied to the crystal. With zero voltage applied to the crystal all the light is undiffracted and is focused by the lenses into a small spot, the zero order image. With a small voltage applied to the crystal some of the light is diffracted out of the zero order image. As the voltage is raised more light is diffracted and therefore less light remains in the zero order image. This continues until at a given voltage, about 100 volts in a typical case, little or no light remains in the zero order. The intensity of light in the zero order is therefore inversely proportional to the voltage on the crystal; hence, if the r-f voltage is amplitude modulated, the light in the zero order is likewise modulated.

The short-range communication device developed at Yale University by Humphreys, Watson and Woernley operates on this modulation principle to permit secret communi-

cation over short distances. The transmitter, the receiver, and a 6-volt vibrator pack yielding 40 watts of power, are all mounted in a single portable well-shielded unit. The ultrasonic diffraction cell of the transmitter consists of a vertical xylene-filled tank with glass sides and a 7-mc quartz crystal resting on the stainless-steel tank bottom. The upper electrode is formed by layers of copper and gold evaporated on the crystal. Electrical contact is made by means of a spring-bronze fork soldered to the gold surface with Wood's metal.

About one watt of r-f power is applied to the crystal by a conventional electron-coupled oscillator with one stage of amplification. A microphone is used with a 6V6GT tube to apply 25-percent modulation to the amplifier stage. Light from a 6-volt Mazda ribbon lamp operated at 8 volts is rendered parallel by a 6-cm diameter achromatic lens and completely fills the cell.

Light from the transmitter is beamed out toward the receiver, initial contact being aided by rifle telescopes mounted on the units. The light beam is received and brought to a focus by an 8-in. diameter lens. Situated at the principal focus of the lens, and slightly in front of an RCA-918 photocell, is a  $\frac{1}{4}$ -in. hole in an opaque diaphragm. The photocell is followed by three 6SJ7 stages of audio amplification which energize a set of earphones in the output circuit.

With zero voltage on the crystal, all of the light from the transmitter is focused on the receiver's photocell. Voltage on the crystal gives rise to an upward beam of ultrasonic waves which serves to diffract the light so that less of it can pass through the diaphragm hole to the photocell. The speech-modulated voltage on the crystal modulates the transmitted light which, in turn, gives rise to a-f currents in the photocell and earphones. This communication system was developed to permit satisfactory conversation at a distance of 3,000 yards in daylight and 5,000 yards at night with a Corning infrared light filter.

### REFERENCE

- (1) P. H. Massant, Distributed Capacitance Chart, *ELECTRONICS*, p 31, March 1938.



Paratrooper's teletypewriter



Field operation of the teletypewriter after assisted jump

## New Military Aids

**R**ECENTLY RELEASED from security classifications, the two equipments illustrated are highlights of development work of the Signal Corps Engineering Lab.

An offshoot of closed-circuit television equipment used to monitor dangerous operations such as the test firing of long-range rockets, the Video-Phone provides two-way aural and visual communication.

A portable teletypewriter, operating continuously at 100 words per minute from a tape, weighs but 45 pounds and is one-fourth the size of its 225-lb predecessor. A parachutist can carry it on a jump from a plane. It is capable of receiving and transmitting 66 percent faster than earlier types.

An experimental camera, "Two-Minute Minnie", employs an electrostatic, electro-photographic process in which light is recorded on a selenium-coated metal plate which has been sensitized by an electric charge. Producing a finished 4 by 5-inch picture two minutes after the shutter is snapped, its plate requires no chemicals for processing and can be used repeatedly by merely wiping off the image. The camera and other gear will be displayed at the 1951 IRE National Convention.

The U. S. Air Force will display

the parabolic static characteristics of a beam-deflection square-law tube on an oscilloscope. This type of square-law tube performs squaring operations on signals ranging in frequency from d-c to 40 mc and higher. Other applications which make use of the mathematical con-

sequences of the squaring operation performed by the tube include linear modulators of the suppressed carrier type, 4-quadrant multipliers of the quadratic type, untuned frequency doublers, instantaneous phase meters, and square-law detectors.



Video-Phone, a two-way television-telephone system



# Detecting Tramp Metal

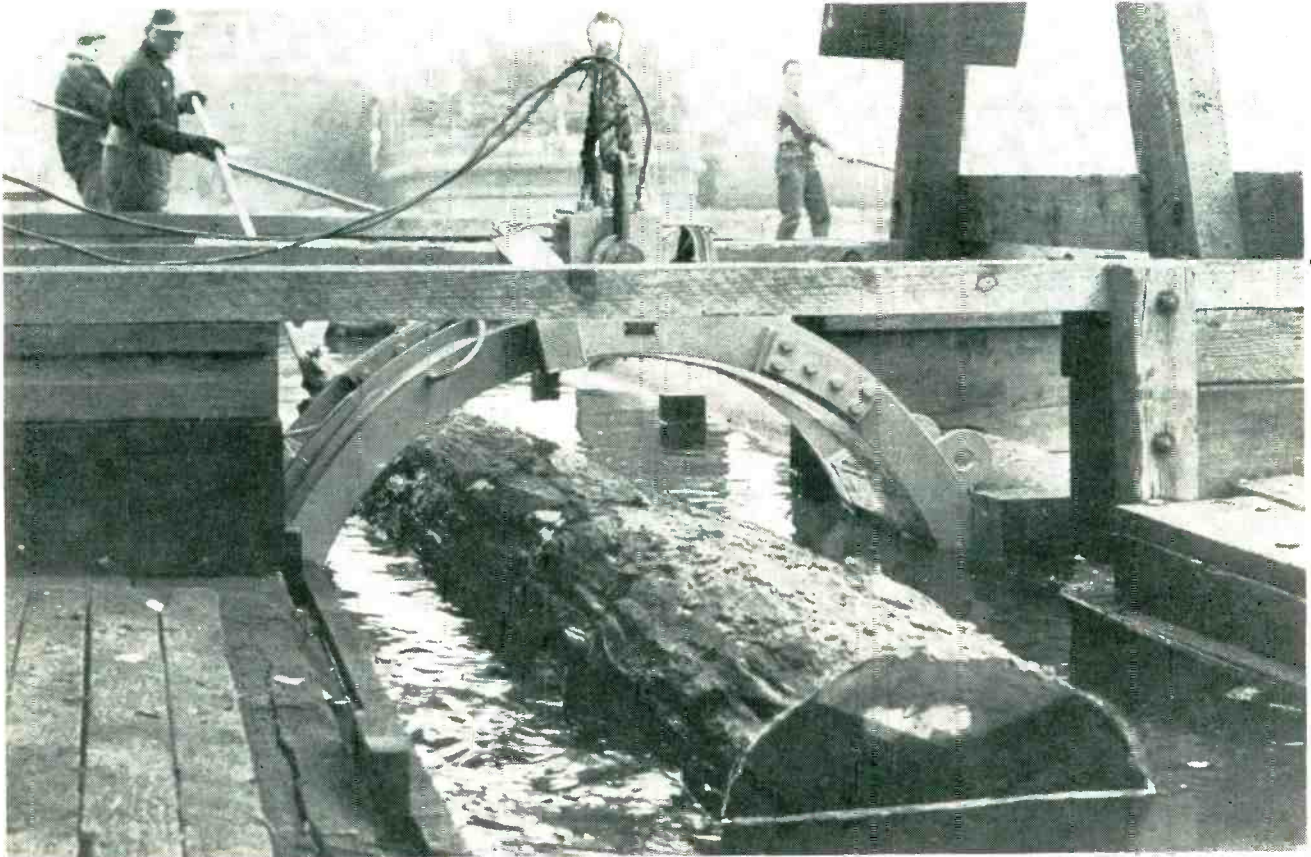

Pair of large magnetic coils, one behind the other, used with GE metal detector for detecting missiles in logs up to 56 inches in diameter floating down sea-water flume at Fort Lewis, Washington. Electronic unit is in remotely located cabinet

**D**ETECTION AND REMOVAL of tramp metal from materials in process is a problem that is yearly increasing in importance. The greater use of automatic machinery in processing lines increases the danger of product contamination from loose or broken machine parts. At the same time, the use of more expensive and complicated processing machinery renders the line more vulnerable to damage and breakdown from the presence of large pieces of tramp. Product quality is also adversely affected in most cases.

When the tramp metal is magnetic and is easily removed from the product material, a magnetic separation method may provide the

This article is based on a paper presented at the 1950 National Electronics Conference. The Conference paper will appear in the *NEC Proceedings*.

By **G. W. CLAPP**

*General Engineering and Consulting  
Laboratory  
General Electric Co.  
Schenectady, N. Y.*

easiest solution to the problem. With the increased use of stainless steel, manganese steel, and other nonmagnetic alloys in process machinery, this simple method is frequently of little help.

When the tramp metal is nonmagnetic, or when its removal from the product is not easy, electronic detection equipment is required to detect and locate the tramp metal which may then be removed manually or by other means.

While a number of different detection principles have been invoked by different workers, in this paper

we will confine our attention to the principle employing an alternating magnetic field.

## **Theoretical Considerations**

In the method under discussion, an alternating magnetic field is generated which fills the whole volume of space that is to be inspected. Any metal particle in this space then acquires a small magnetic dipole moment, the combined result of eddy currents and magnetic polarization induced in the particle by the inspection field. The external field of the induced dipole will in turn induce a small voltage in the coil or coils used to excite the inspection field. This voltage may be detected as a small change in the impedance of the exciting coils. Alternatively, the particle may be detected by the small voltage induced in a passive secondary coil

# in Logs and Iron Ore

Analysis of problem of detecting a spherical metal particle in an alternating magnetic field, and two practical applications of the solution—detecting bullets and shell fragments in logs partially submerged in sea water, and detecting broken drill bits and other tramp metal in highly magnetic taconite iron ore

**Table I Maximum-Loss Conditions**

Material and Assumed Conductivity in $10^6$ mhos	Assumed Permeability	$\left(\frac{\gamma}{\mu}\right)_m$
Copper (0.59) .....	1	2.5
Brass (0.13) .....	1	2.5
Lead (0.048) .....	1	2.5
Aluminum (0.36) .....	1	2.5
Mild Steel (0.077) .....	250	0.7
18-8 Stainless (0.025) .....	3	1.2
Manganese Steel (0.014) .....	3	1.2

or coils so placed as to link the external field of the induced dipole. In any method of detection using these principles, a fundamental problem is the calculation of the strength of the dipole moment induced in the particle.

### Static Alternating Field

One of the classic problems<sup>1</sup> in magnetostatics involves the calculation of the magnetic polarization induced in a homogeneous spherical particle when placed in a uniform magnetic field of strength  $H_o$ . In solving this problem, it is found that the field external to the particle may be considered as the linear superposition of the original uniform field  $H_o$  and the field of a magnetic dipole of strength  $m$  located at the center of the particle. The dipole strength is given by

$$\bar{m} = \frac{3(\mu - 1)}{4\pi(\mu + 2)} V \bar{H}_o \quad (1)$$

where  $V = \pi d^3/6 =$  volume of spherical particle in  $\text{cm}^3$ ,  $d =$  diameter of sphere in cm,  $\mu =$  permeability of sphere relative to free space, and a horizontal bar over a symbol is used to emphasize its vectorial nature.

The solution of this same problem for the more general case where the applied magnetic field is alternating has been worked out by H. Poritsky in a separate paper now being prepared for publication.

According to Poritsky's results, when the applied magnetic field is  $H_o e^{j\omega t}$ , the complex induced magnetic dipole moment is given by

$$\bar{m} = \frac{3}{8\pi} \left( \frac{2\mu + 1 - W}{\mu - 1 + W} \right) V \bar{H}_o \quad (2)$$

$$W = \frac{(\gamma + j\gamma)^2 \tanh(\gamma + j\gamma)}{(\gamma + j\gamma) - \tanh(\gamma + j\gamma)} \quad (3)$$

$$\gamma = \pi d \sqrt{\mu \sigma f} \times 10^{-9} \quad (4)$$

where  $\sigma =$  conductivity of sphere in mhos,  $\mu =$  permeability of sphere relative to free space,  $f = \omega/2\pi =$  frequency of field and  $d =$  diameter of sphere in cm.

The depth of current penetration ( $\delta$ ) is commonly defined as  $\delta = 1/2\pi\sqrt{\mu \sigma f} \times 10^{-9}$ . The quantity  $\gamma$  is thus equal to the ratio of the radius of the sphere to the depth of current penetration.

Because of the assumed spherical symmetry of the particle, the di-

rection of  $m$  is parallel to  $H_o$ .

For the discussion to follow, it will be convenient to introduce the complex quantity

$$X + jY = \frac{2\mu + 1 - W}{\mu - 1 + W} \quad (5)$$

Then Eq. 2 becomes

$$\begin{aligned} \frac{\bar{m}}{V \bar{H}_o} &= \frac{3}{8\pi} \times \frac{(2\mu + 1 - W)}{(\mu - 1 + W)} \\ &= \frac{3}{8\pi} (X + jY) \end{aligned} \quad (6)$$

In Fig. 1 the complex quantity  $(X + jY)$  is plotted as a function of  $(\gamma/\mu)$  for various assigned values of  $\mu$ . Four special cases are of interest.

(a)  $\gamma \rightarrow 0$  (Static Case). This case arises if  $f$ , the frequency of the applied field, approaches zero, or if the conductivity of the particle is zero. In this case  $W$  has the constant value 3, and Eq. 6 becomes equivalent to Eq. 1, the solution of the static problem. This solution is represented in Fig. 1 by the points on the real axis between 0 and 2. Since the solution in this case is a positive real number, the induced moment  $m$  is in phase with  $H_o$ .

(b)  $\gamma \rightarrow \infty$  (High-frequency

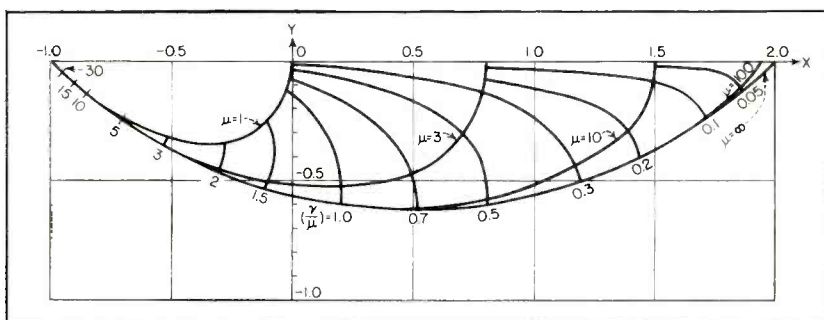

FIG. 1—Plot used in solving for the complex quantity  $X + jY$  involved in finding the magnetic polarization induced in a spherical particle having various permeability values when in an alternating magnetic field



Case). This case arises if the depth of current penetration in the particle becomes very small in comparison with the radius of the particle, so that essentially no flux penetrates the sphere. In this case, the solution is represented by the single point  $(-1 + j 0)$ , and the induced moment  $m$  is 180 degrees out of phase with  $H_o$ .

(c)  $\mu = 1$  and  $\gamma$  is small. When  $\mu = 1$ , Eq. 5 becomes

$$X + jY = (3 - W)/W \quad (7)$$

Expanding this in powers of  $\gamma$  for  $\gamma \ll 1$ , the asymptotic solution is

$$X + jY = -\frac{8}{315} \gamma^4 - j \frac{2}{15} \gamma^2 \quad (8)$$

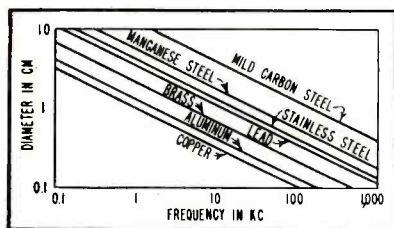

FIG. 2—Frequency for maximum loss component as a function of particle diameter

This solution is valid only for small values of  $\gamma$ . In this case the induced moment is derived solely from the eddy currents in the sphere. The phase angle of the moment  $m$  is essentially 90 degrees behind that of the applied field  $H_o$ . From this it may be seen that, for small values of  $\gamma$ , the principal effect of these eddy currents is to introduce energy losses in the system.

(d) *Maximum-loss condition.* It is of interest to determine the frequency of the applied field at which maximum losses occur in a particle of given diameter  $d$ . For this purpose the values of  $(\gamma/\mu)$  corresponding to the minima of the curves of Fig. 1 have been read off for different common materials and given as  $(\gamma/\mu)_m$  in Table I.

When the value of  $(\gamma/\mu)_m$  for a particular material is known, the frequency required to produce maximum losses (at constant field strength  $H_o$ ) in a particle of diameter  $d$  cm is given by

$$f_m = \mu \left( \frac{\gamma}{\mu} \right)_m \times 10^9 \quad (9)$$

Values of  $f_m$  as a function of diam-

eter  $d$  for different materials are plotted in Fig. 2.

### Detection of Induced Dipole Field

So far we have considered only the interaction of the metal particle and applied field. In order to detect such a particle we must also consider the means used to generate the search field and to detect the induced field of the particle itself.

In Fig. 3 let the coil  $L_p$  be the means used to generate the search field, and let  $\bar{H}_p$  be the magnetic field intensity in lines per cm<sup>2</sup> at a point  $P$  caused by a current of 1 ampere in  $L_p$ . Let the coil  $L_s$  be the means used to detect the presence of a metal particle in the field of  $L_p$ , and let  $\bar{H}_s$  be the field that would have been produced at  $P$  by a current of 1 ampere flowing through  $L_s$ . Assuming the metal particle is so small that the fields  $\bar{H}_p$  and  $\bar{H}_s$  are essentially uniform over the volume of the particle, it may then be shown that, with unit current in  $L_p$ , the voltage in volts induced in  $L_s$  as the result of field distortion caused by a small metal sphere at  $P$  is given by

$$e_s = -j \omega \frac{3V}{8\pi} (X + jY) (\bar{H}_p \cdot \bar{H}_s) \times 10^{-8} \quad (10)$$

where  $(\bar{H}_p \cdot \bar{H}_s)$  is the scalar product of the two vectors  $\bar{H}_p$  and  $\bar{H}_s$ .

It may therefore be seen that the introduction of the metal particle into the field of the two coils results in a change in their mutual impedance given in ohms by

$$\Delta Z = j \omega \frac{3V}{8\pi} (X + jY) (\bar{H}_p \cdot \bar{H}_s) \times 10^{-8} \quad (11)$$

### Single-Coil System

Let us consider now the case where  $L_p$  and  $L_s$  are superimposed, the same coil being used both to generate the search field and to detect the induced field of the particle<sup>2,3</sup>. In this case  $\bar{H}_p = \bar{H}_s$ , and the presence of the particle produces a change in the self-impedance of the coil given in ohms by

$$\Delta Z = j \omega \frac{3V}{8\pi} (X + jY) |H|^2 \times 10^{-8} \quad (12)$$

where  $|H|$  is the magnitude of the field produced at the position of the particle by a current of 1 ampere in

the coil. If the particle is located at the center of a coil of  $n$  turns whose diameter is  $D$  cm and whose winding cross-section is small in comparison with  $D$ , then the expressions for lines per sq cm and for impedance in ohms are

$$|H| \cong \frac{4\pi n}{10D} \quad (13)$$

$$\Delta Z = j \omega \frac{6\pi n^2 V}{D^2} (X + jY) \times 10^{-10} \quad (14)$$

The self-inductance in henrys of such a coil in the absence of a metal particle can be approximated by

$$L_o = \pi^2 K n^2 D \times 10^{-9} \quad (15)$$

where  $K$  is a dimensionless factor depending only on the shape and size of the cross-section of the coil in relation to the mean coil diameter  $D$ . For typical compact coils,  $K$  varies between 0.8 and 2.0. Assuming that the impedance of the coil  $Z_o$  is approximately equal to  $j\omega L_o$ , the fractional change in impedance of the coil due to a metal sphere of diameter  $d$  at its center is

$$\frac{\Delta Z}{Z_o} = \frac{d^3 (X + jY)}{10 K D^3} \quad (16)$$

The fractional change in impedance forms a convenient figure of merit for a metal detector problem since, in general, the size of this ratio determines the ease with which the particle may be detected. From Eq. 16 it is seen that, for a particle at the center of the coil, this ratio varies as the cube of the ratio of the particle diameter to the coil diameter. The magnitude of the metal detection problem can be appreciated by noting that to detect a particle whose diameter is one percent of the coil diameter, it is necessary to detect a change in coil inductance of the order of 1 part in 10 million.

If the particle is moved to a different point in the field, the fractional change in impedance will assume a new value proportional to  $|H|^2$  at the new point. For points

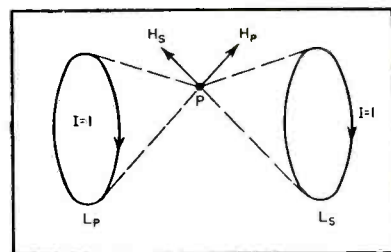

FIG. 3—Generation of metal detector field

on the axis of the coil and a distance  $x$  from its center, we find

$$\frac{\Delta Z}{Z_0} = \frac{d^3 D^3 (X + jY)}{10 K (D^2 + 4 x^2)^3} \quad (17)$$

hence at large distances from the coil, the sensitivity falls off as the sixth power of the distance.

Figure 4 shows a set of field contours plotted to show points of equal detection sensitivity in the field of a single circular coil. The quantity  $d$  noted on the contours is proportional to the particle diameter needed to produce a given signal level in the coil. The quantity  $d$  is therefore proportional to  $H^{-2/3}$ .

### Multiple-Coil Systems

While metal detectors have been built using the single-coil arrangement, it is frequently found advisable, when maximum stability is desired, to use two or more coils in a balanced bridge arrangement. By this means the effects of spurious changes in coil impedance due to such factors as ambient temperature changes may be minimized.

Let  $L_1$  and  $L_2$  be two similar coils connected in adjacent arms of a simple Wheatstone bridge circuit. Assuming the coils carry approximately equal bridge current, the total exciting field is given by  $H_p = H_1 + H_2$  where  $H_1$  and  $H_2$  are the fields produced by unit bridge current in the coils  $L_1$  and  $L_2$  respectively. Since the output or detector current in a bridge always flows in a direction opposite to the exciting current in one of two adjacent bridge arms, the field corresponding to the detector field  $H_d$  in Fig. 3 is given by  $\bar{H}_d = \bar{H}_1 - \bar{H}_2$ . Inserting these values of  $\bar{H}_p$  and  $\bar{H}_d$ , Eq. 11 becomes . . . . .

$$\begin{aligned} \Delta Z &= j\omega \frac{3V}{8\pi} (X + jY) (\bar{H}_1 + \bar{H}_2) \\ &\quad (\bar{H}_1 - \bar{H}_2) \times 10^{-8} \\ &= j\omega \frac{3V}{8\pi} (X + jY) (|H_1|^2 - |H_2|^2) \\ &\quad \times 10^{-8} \end{aligned} \quad (18)$$

Field contours for two such coaxial coils separated by a distance equal to their radius are shown in Fig. 5. Since the field contours are independent of the direction of the exciting current in either coil, it is usual to connect the coils in the polarity which minimizes external inductive interference.

In addition to the two simple coil

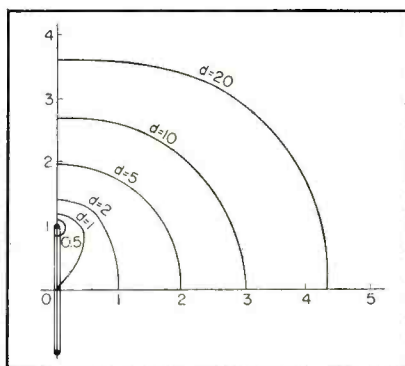

FIG. 4—Signal contours for single circular coil

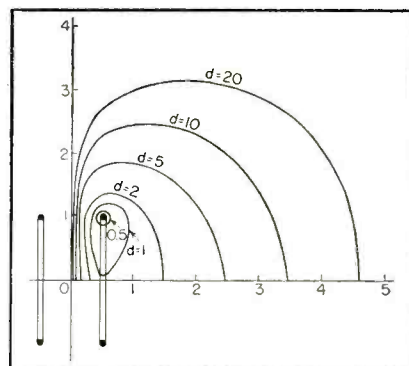

FIG. 5—Signal contours for pair of circular coils in bridge connection

arrangements discussed here, many more complicated systems have been described in the literature<sup>4,5,6</sup>. These systems are usually designed to produce the most uniform detection sensitivity over the volume of space to be inspected, although other problems such as ease of manufacture and mechanical stability must also be considered. Any of these coil arrangements may be analyzed for the case of a spherical metal particle by further application of the method described above.

### Shape Factor

In practice, the shape of the particle to be detected frequently differs from that of the ideal sphere assumed up to this point. An elongated particle may give a signal either larger or smaller than a spherical particle of the same volume depending on the material, its orientation in the field and the frequency of the field. Lack of space prevents discussion of this important but complex phase of the metal detection problem at this time. In practice it is usual to design for a spherical particle whose size has been determined empirically for the particular detection problem at hand.

### Metal Detection in Logs

As an example to illustrate the application of the principles discussed above, let us consider a problem requiring the detection of tramp metal in logs. In the particular example to be described, the logs were cut from forests that had been used for military exercises and were severely contaminated with bullets, shell fragments and some unexploded shells.

To be suitable for this application, the equipment had to be capable of detecting the equivalent of a 3/8-inch diameter steel ball anywhere in the body of a log 56 inches in diameter. For ease in handling, the logs were to be passed through the inspection area while floating in water. The inspection coils were therefore required to operate while partially submerged in sea water. The coils and detector were required to have the minimum of sensitivity to mechanical shock and to be capable of operation without frequent adjustment.

To meet the requirement of high sensitivity in combination with high stability, a balanced mutual-inductance type coil system was chosen. For best mechanical stability, and because of the shape of the material to be inspected, coaxial circular coils were used with the logs passing completely through the coils in the axial direction. A five-foot inside coil diameter was selected to permit passage of the largest log through the coil assembly. To permit operation under changing weather conditions without frequent readjustment, an automatic balancing circuit was included in the detector. This circuit, to be described in detail later, maintained the coils in the most sensitive balance condition over much wider variations in temperature than would otherwise be possible.

Since the coils were to be partially submerged in sea water, a large change in the conductivity of the space surrounding the coils was to be expected each time the end of a log approached. To reduce eddy currents in the water and thus avoid false alarms from this cause,



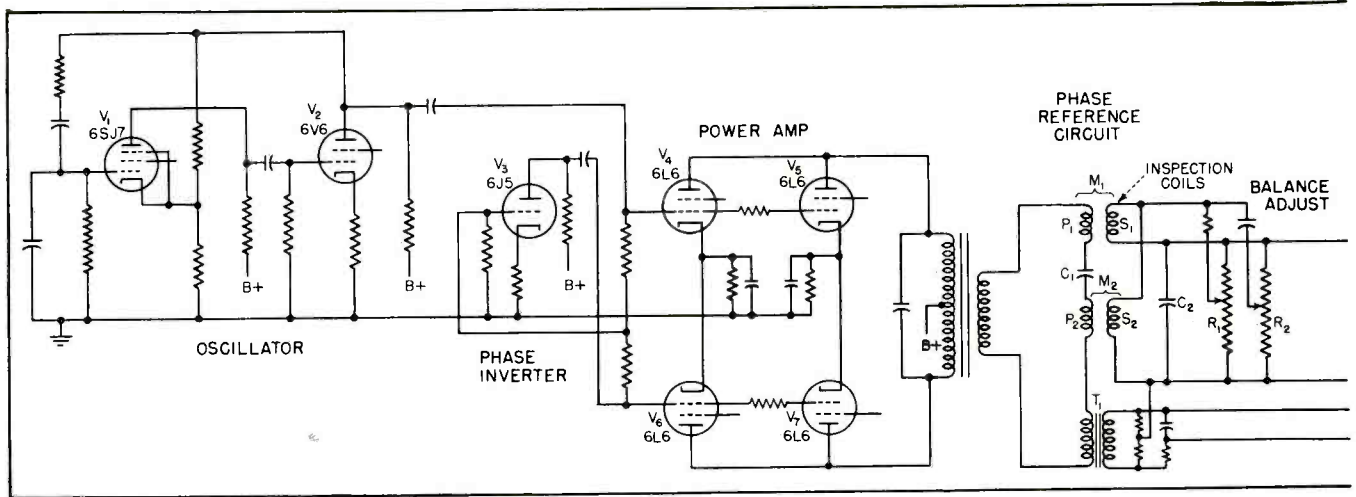

FIG. 6—Simplified circuit of metal detector developed for finding shells and other relatively large metal objects

the frequency of the coil current was made as low as practicable.

Even at the low frequency of 25 cps used in this detector, an approximate calculation using Eq. 4, 6 and 8 shows that a 36-inch sphere of sea water having a conductivity of 0.05 mho per cm could be expected to produce a signal roughly equal to that produced by a  $\frac{3}{8}$ -inch sphere of iron. (An exact calculation cannot be made using these equations because the exciting field is not uniform over the volume of the water sphere.)

Additional discrimination against the sea-water signal was therefore necessary. It was secured in this instance by making use of the fact that the water signal is almost 90 degrees out of phase with the signal produced by an iron particle. To aid in discriminating between the two signals, the detector alarm was operated from a phase-sensitive rectifier adjusted to be relatively insensitive to signals having the phase of the water signal.

The circuit diagram of the detector is shown in simplified form in Fig. 6. The 25-cycle current for the detector is provided by an oscillator and power amplifier of conventional design. This current is fed to primary windings  $P_1$  and  $P_2$  of the coil assembly to generate the inspection field. It is also supplied, for phase reference purposes, to the detector and compensator circuits through transformer  $T_1$ .

Windings  $P_1$  and  $P_2$  are connected in series aiding and are tuned to resonance by  $C_1$ . Secondary windings  $S_1$  and  $S_2$  are connected in

series opposing and are tuned to resonance by  $C_2$ . If mutual inductances  $M_1$  and  $M_2$  are equal, the net voltage appearing across  $C_2$  will be zero. If a piece of metal enters the field of one of the windings, this mutual inductance balance will be upset and the resulting signal across  $C_2$  may be used to detect its presence. Potentiometers  $R_{1a}$  and  $R_{2a}$  permit accurate adjustment of the balance point.

Any unbalance voltage appearing across  $C_2$  is amplified through  $V_{5a}$ ,  $V_{5b}$ , and  $V_{10}$  and applied to two phase-sensitive detectors  $V_{11a}$  and  $V_{11b}$  in parallel. These two detectors are sensitive to resistive unbalance signals and inductive unbalance signals respectively, the latter being connected to operate alarm relay tube  $V_{12}$ . In addition, each detector supplies control voltage to a compensating circuit ( $V_{9a}$ ,  $V_{9b}$ ). This compensating circuit cancels out the signal resulting from a slow drift in coil balance such as might be produced by unequal expansion of the coil forms but has relatively little effect on the more rapidly varying signals produced by moving a piece of metal through the coils.

This detector has been in service since January 1949 with excellent results. By its use, several unexploded shells of dangerous size were located and safely removed from logs. Sensitivity was sufficient to detect a large number of machine-gun bullets and small shell fragments of comparable size.

A second problem will serve to illustrate the application of these

same principles in yet a different way. This problem involves the detection of both magnetic iron and nonmagnetic manganese steel in taconite iron ore. The sensitivity required in this instance is not as high since the tramp metal consists of broken shovel teeth, jack bits and similar objects large enough to damage ore-crushing machinery. The problem here resides in the fact that the ore itself is so highly magnetic that neither magnetic pulleys nor the more common types of electronic metal detectors can be used successfully.

Tests disclosed that while some streaks or filaments of high electrical conductivity are commonly found in the ore, its average conductivity is much lower than that of the tramp metal. This fact can be exploited to provide satisfactory though not perfect discrimination between ore and metal.

### Detecting Metal in Ore

To provide a signal having the maximum loss component from tramp metal of the size to be detected ( $1\frac{1}{4}$  inch diameter, minimum) an inspection coil frequency of 4,000 cps was selected on the basis of the data given in Fig. 2. At this frequency, the signal obtained from the ore itself was found to have a very strong reactive component but a comparatively weak loss component.

Successful operation of the detector therefore depends on its ability to reject very large ore signals in quadrature with the phase of the inspection field, while

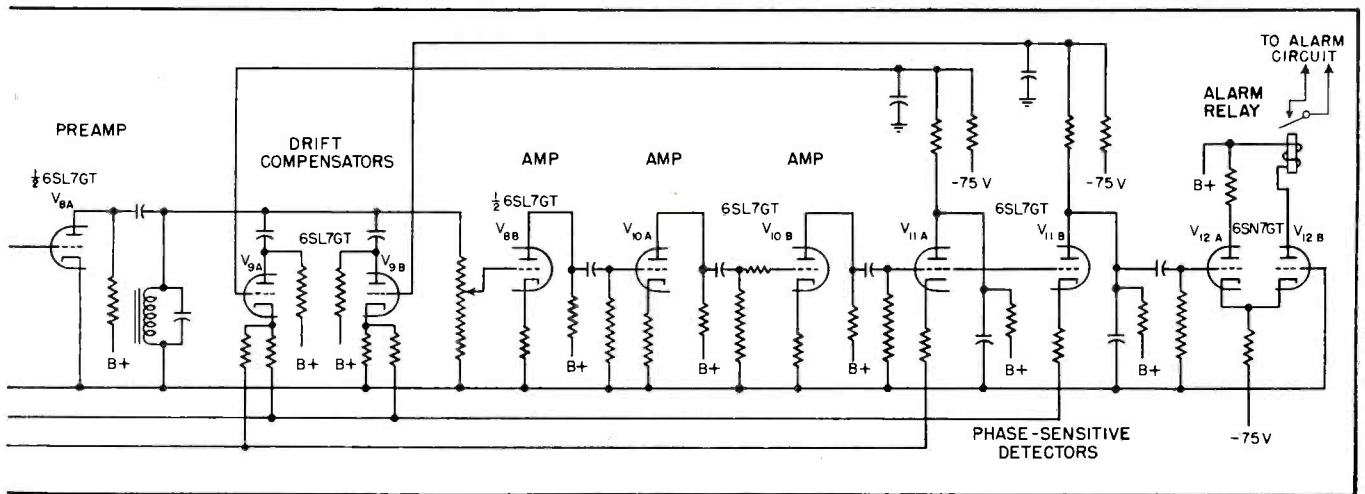

imbedded in logs floating down salt-water flume. Oscillator and amplifier at left feed energizing coils  $P_1$  and  $P_2$ .

detecting much smaller signals in phase with the inspection field. To provide this phase discrimination stably and consistently over long periods of time, the inspection coils were connected in a special bridge circuit which includes the phase-discriminating elements as part of the bridge.

A simplified circuit diagram of such a detector is shown in Fig. 7A. The 4,000-cps power supply used to furnish exciting current for the bridge consists of an oscillator and power amplifier similar to that shown in Fig. 6 and is therefore not repeated here.

Inductances  $L_1$  and  $L_2$  forming the inspection coils each consist of two windings in series, one below the ore conveyor belt, the second directly above the first and spaced apart a distance sufficient to allow the ore and belt to pass between. The two sets of windings comprising  $L_1$  and  $L_2$  are spaced along the length of the belt so that a piece of metal carried thereon unbalances the bridge first in one direction, then in the other.

Figure 7B is a voltage vector diagram showing the bridge in balanced condition. The subscripts on the vector symbols refer to the circuit junction points. The diode rectifier connected to junction b allows a current proportional to the magnitude of  $E_{eb}$  to pass in one direction through resistors  $R_1$  and  $R_2$ . Similarly, the rectifier connected to junction c allows a current proportional to the magnitude of  $E_{ec}$  to pass in the opposite direction through  $R_1$  and  $R_2$ . When the bridge

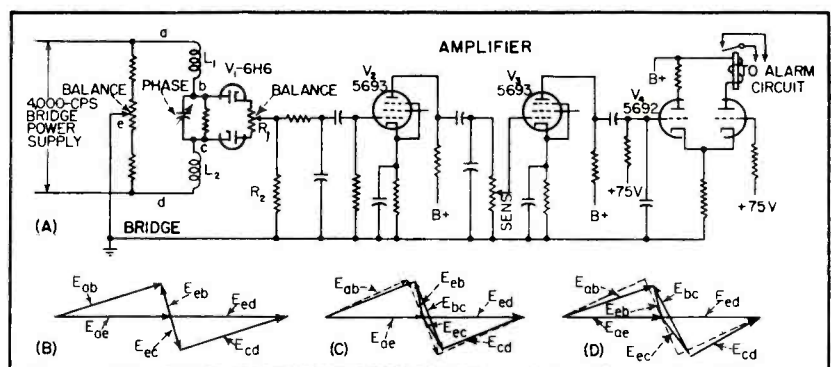

FIG. 7—Simplified circuit of metal detector as modified for detecting tramp metal in iron ore on conveyor belt

is in balanced condition as shown, these currents are equal and hence the net current through load resistor  $R_2$  is zero.

Figure 7C shows the effect of a change in inductance of one arm not accompanied by a change in resistance. This would correspond to a typical ore signal. In this case the magnitudes of  $E_{ob}$  and  $E_{oc}$  remain equal and the net current through load resistor  $R_2$  is still zero.

Figure 7D shows the effect of an inductive unbalance accompanied by a resistive unbalance such as might be produced by a piece of tramp metal in the field of one coil. In this case, vectors  $E_{ob}$  and  $E_{oc}$  are no longer equal in magnitude and a net d-c voltage appears across  $R_2$ . The transient voltage swing across  $R_2$  resulting from temporary unbalance of the bridge by metal is amplified by  $V_2$  and  $V_3$ . This amplified signal is then used to control the action of an alarm relay through  $V_4$ .

To reduce the ore signal to a

minimum in the commercial version of this metal detector, three independent sets of inspection coils are used to cover the full width of the belt. The clearance between top and bottom sets of coils is 10 inches. This detector is now under test in a mill in northern Minnesota with very encouraging results to date.

The writer wishes to acknowledge his appreciation to Dr. H. Poritsky of this laboratory for permission to use some of his results in this paper in advance of their publication elsewhere.

#### REFERENCES

- (1) J. J. Thomson, "Elements of Electricity and Magnetism," Fifth Edition, Cambridge Press, p. 200.
- (2) Kenneth Urbach, Metal Detector for Conveyors, *ELECTRONICS*, p. 80, July 1949.
- (3) J. G. Clark and C. F. Spitzer, Electronic Locator for Salvaging Trolley Rails, *ELECTRONICS*, p. 129, Jan. 1944.
- (4) Curtis R. Schafer, Metal Detector for the Lumber Industry, *ELECTRONICS*, p. 100, Sept. 1949.
- (5) B. Boston, Development of Locators of Small Metallic Bodies Buried in the Ground, *Journal IEE*, p. 653, Dec. 1948.
- (6) L. F. Curtis, Detectors for Buried Metallic Bodies, *Proc. NCC*, p. 339, 1946.



# P-M FOCUS DEVICES

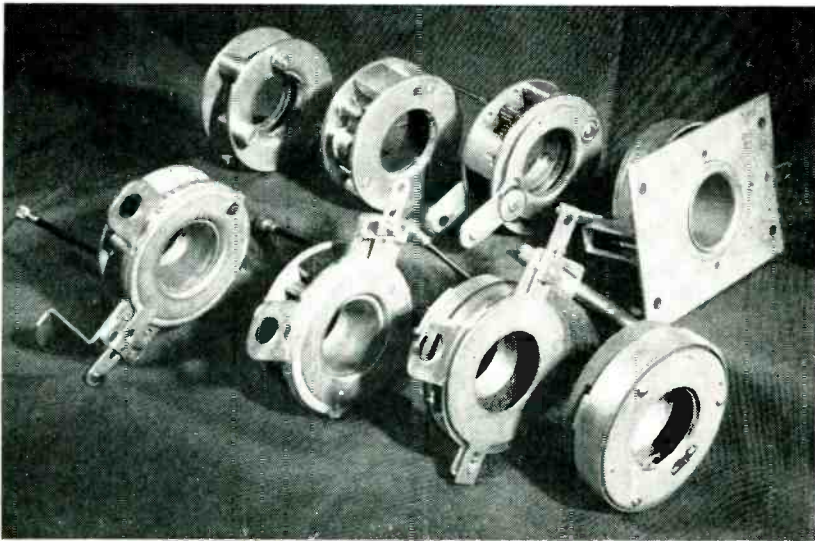

Various types of p-m focus units were tested, each on several different standard television receiver chassis

By **KENNETH JAMES** and **R. T. CAPODANNO**

*Electrical Engineer*                      *Director of Engineering*  
*Emerson Radio and Phonograph Corporation*  
*New York, N. Y.*

**T**HE HIGH COST of the electromagnetic focus unit and its power supply has been a serious item in the cost of all but the smallest television sets. It is largely in an attempt to reduce this cost that the cheaper permanent-magnet type focus unit has been developed.

In deciding how good a focus system must be to give satisfactory performance, it is necessary to consider the maximum spot size that may be used without causing deterioration of picture quality. Assuming about 480 active lines in each complete picture on a 16-inch tube, each picture element is about 0.025-inch square. The spot at maximum brightness should not exceed this size; it should be smaller, at least in the horizontal direction, if amplifier compensation is not used.

It is difficult to get a spot as small as this at maximum brightness because of limitations imposed by the picture tube, such as the effective grid aperture which must have a finite size. Added to this are the effects of aberrations and magnification caused by the type of focus system used. The limitations imposed by the picture tube itself are not considered in this article. We will

discuss only those aberrations caused by the permanent-magnet focus unit.

## **Experimental Work**

In examining departures from ideal conditions it was found necessary to set up a means of measuring, with some accuracy, the size of the spot produced on the screen when the picture tube is operated at a control grid-cathode voltage of zero volts and with normal anode voltage (13 kv in the case of these tests). The picture tubes used for this purpose were mounted in a commercial chassis from which all steel supports and other magnetic material near the tube had been removed.

The p-m units to be investigated were supported on the tube by a suitable thickness of adhesive paper tape wrapped around the neck of the tube. This method of mounting provides an easy and accurate method of setting the magnet coaxially with the tube neck and, therefore, nearly coaxially with the beam. The yoke was disconnected but left in position on the neck of the tube to form a stationary spot.

When running a test, the beam is

held beyond cutoff and pulsed to zero volts by means of a pulse generator. The frequency of the pulse is 500 pulses per second and the pulse duration is 20 microseconds. The peak positive voltage is determined by means of a simple peak meter consisting of a diode, a capacitor and a vtvm set at the three-volt d-c range. This testing arrangement is illustrated in Fig. 1A. The pulse generator output is adjusted so that the voltmeter is just at the point of moving off zero volts, thus giving nearly zero volts on the peak grid pulses with reference to the cathode.

To examine adequately the nature of the spot produced, it was found necessary to enlarge it. This was done by setting up a 4-inch f/1.8 projection lens to give a linear magnification of 10. The image produced is projected onto a sheet of graph paper. As there is considerable loss of light by this method, it is necessary to carry out the test in a dark room.

The diameter of well-focused spots is relatively easy to ascertain. For spots with very diffused edges, it was found useful to describe their diameter in terms of (a) the diameter of a circle enclosing all points which were more than one-half as bright as the brightest part of the spot, and (b) the diameter of a circle enclosing all points more than one-tenth as bright as the brightest part of the spot.

A special light meter is used to measure the low illuminations over the small areas involved in the enlarged spot. The meter used is manufactured by Salford Electrical Industries of Ilford, London. It covers a range of 1/100 ft lambert to 10,000 ft lamberts, and can be used on an area as small as 1/100 square inch or less.

When only a qualitative estimate is required, a polka-dot generator

# for PICTURE TUBES

Main disadvantage of permanent-magnet focusing devices is stray field that spreads into ion trap and deflection yoke regions. Success of p-m focus units depends on mechanical design and construction. Pole pieces must be operated well below saturation

may be used with the normal deflection system. This technique has been described in previous publications in connection with yoke design. It provides a good indication of the performance of the focus magnet alone when the area near the center of the tube is examined. This method has the advantage of showing up field distortions and rotation caused by stray focus fields penetrating the yoke. The field strengths of the p-m focus units used were measured by means of a small search coil and fluxmeter, where the flux density was of high magnitude, and by a General Electric Gaussmeter where the flux density was low.

## Requirements for Good Focus

A good magnetic focus system should meet the following requirements: (1) It must provide correct magnetic strength to ensure that an image is formed on the screen. (2) It must have uniform magnetic field over the region through which the beam travels. (3) Its magnetic field must be approximately coaxial with the beam. (4) The magnetic field must be as far toward the front of the tube as possible, subject to certain considerations which will be discussed later. (5) The

focus field must be restricted to the region of the tubes where the focusing action is required.

It is the aim of this paper to show causes of departures from these ideal conditions and their effect on the size of the spot produced.

The focus field forms a lens focusing the image on the screen. The strength of field required depends not only on the geometry of the system but also on the square root of the final anode voltage. The effect on the spot size due to change in high voltage is shown in Fig. 1B.

In an electromagnetic system any change of circuit conditions (such as supply voltage, aging of horizontal output tube or reduction in B supply voltage) which results in a change of high voltage, is generally accompanied by a change in focus current in the direction needed to correct the defocus produced. The correction is only approximate but is usually sufficient to take care of changes in high voltage caused by normal line-voltage variations and moderate component aging. No such correction occurs in a permanent-magnet focus system for the obvious reason that there is no focus current present.

If the focus field is not axially

symmetrical over the area traversed by the beam, different parts of the beam will suffer different focusing forces and the beam will not focus properly.

If the field is not coaxial with the beam, the beam will be deflected. Use is made of this phenomenon to center the raster in its correct position on the tube by means of a plate not concentric with the polepieces. Movement of the plate distorts the field in the desired direction. With this method of centering there is always some defocus produced.

The focus coil will cause the minimum magnification of the object if it is as far from the object and as near to the image as practicable. This indicates that the focus unit should be as near to the front of the tube as possible. There are, however, certain limitations to this. Room must be found on the neck of the tube to accommodate the yoke. The stray field from the front of the focus coil must not cause excessive interference with the yoke. The beam leaving the final anode is slightly divergent. The further forward the focus field is placed, the larger the cross-section of the beam becomes at the point where it is subjected to the focus field, and the more susceptible it will be to

Table I—Measurements of Intensity and Effect of Stray Field in Ion Trap and Yoke Regions

Type of Focus Unit*	Stray Field 1 inch to Rear on Axis in Gauss	Stray Field 1 inch to Rear and off Axis in Gauss	Effect on Ion Trap Operation (Using 45-Gauss Ion Trap)		Stray Field 1 inch in Front on Axis in Gauss	Stray Field 1 inch in Front and off Axis in Gauss	Raster Rotation in Degrees
			Short-neck Tube	Long-neck Tube			
(A)	12	8	Very Slight	Negligible	25	15	5
(B)	32	40	Serious	Very Slight	35	40	20
(C)	45	60	Serious	Noticeable	38	40	21
(D)	45	50	Serious	Noticeable	38	48	23
(E)	52	68	Almost Unusable	Noticeable	31	50	24

\* (A) Electromagnet. (B) P-M with 1/2-inch steel screw as shunt between pole faces, (C) P-M with variable-gap adjustment set to focus at 13 kv on a 16RP4, (D) and (E) P-M units with large fixed gaps and with external shunts.



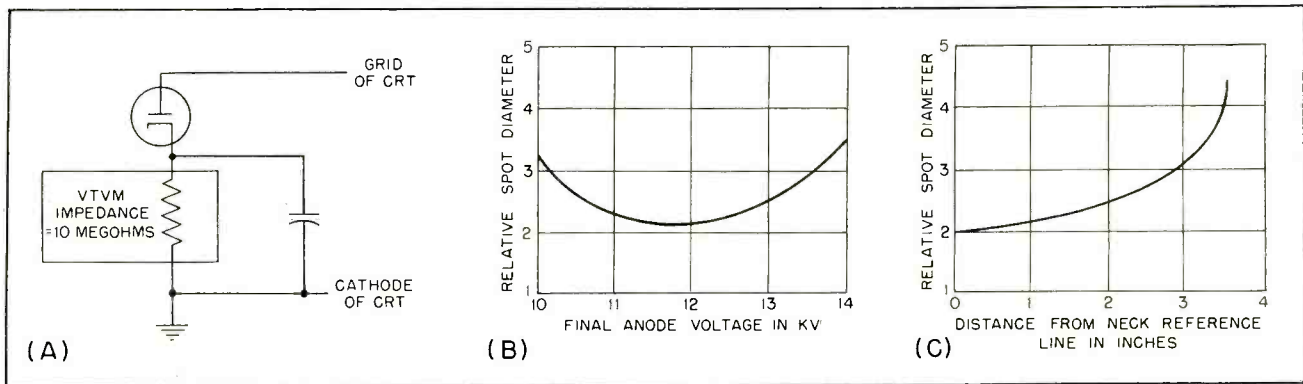

FIG. 1—Test setup is shown in A. Relative spot size is shown in B and C as function of final anode voltage and position of focus unit

defocus due to nonuniformity of the fields of both the focus coil and the yoke.

A good focus unit with uniform field and with limited stray field will give the smallest spot when moved as far forward as possible. Figure 1C shows the relationship between the size of the spot and the position on the tube of the focus unit.

### Focus Field Spread

The most important aspect of focus design is the restriction of the magnetic field spread from the focus unit, so that it does not affect the adjacent components on the tube neck.

Penetration of the stray field into the ion trap and grid regions has three main effects:

(1) It moves the center of the electron lens back toward the object. This is usually undesirable because it increases the magnification and in turn the spot size.

(2) It may penetrate the region of low-velocity electrons, thus making good focus impossible.

(3) It may deflect the beam as it curves through the ion trap so that it no longer passes through the aperture in the final anode. This latter is the most obvious of these effects as it makes the ion trap and focus coil adjustments interdependent. This condition is particularly serious in the hands of semiskilled operators. It is well known that apparent good focus can be obtained by allowing only a small part of the beam to leave the gun. This happens when the ion trap is misadjusted so that most of the beam fails to find its way through the aperture. If this misalignment had been done by changing the

focus field, it is easy to set up this position of false focus, resulting in poor illumination and the rapid destruction of the tube by gas released from the heated edge of the anode aperture. One sample focus unit was adjusted on a 16GP4 tube. The field strength was then increased by 20 percent. This caused severe ion-trap interaction which in turn produced complete spot extinction.

Penetration of the stray field into the yoke region causes a rotation of the raster. This in itself is not serious as it may be corrected by rotation of the yoke.

Severe interaction, however, is accompanied by defocusing and raster distortion, the mechanism of which was not investigated. As the amount of rotation of the raster is affected by the strength of the stray field, it may be necessary to readjust the yoke position after focusing.

Spread of the stray field to surrounding steel structures, such as the brackets supporting the magnet, chassis and yoke supports, may cause distortion as well as weakening and unbalance of the wanted focus field. This condition may be rendered less serious by using non-magnetic brackets. However, it is preferable to eliminate the trouble at its source as far as possible by restricting the stray field to a minimum.

### Focus Magnet Parts

All types of permanent-magnet focus units consist of three essential parts: (1) One or more pieces of alnico forming the permanent magnet. (2) Pole pieces to direct the field to that part of the tube where it is required. (3) A device

which may or may not be part of the pole pieces, to adjust the field to its correct strength. A generalized picture of such a magnet without the field strength adjusting or focusing device is shown in Fig. 2A. This diagram shows the approximate distribution of the stray fields in such a device.

The permanent magnet may be in the form of a ring of alnico larger than the neck of the tube, or in the form of three or more pieces of alnico held between mild steel end plates or pole pieces. It is important that the field produced in the focus region be axially symmetrical. This implies that the ring be uniformly magnetized or that the magnets themselves be of equal strength and uniformly distributed around the circumference. If this is done, then there should be little need for redistribution of the flux in the pole pieces in order to produce a uniform field in the gap.

The pole piece directs the field from the permanent magnets into the correct position, and distributes the available flux so that it produces an axially symmetrical field in the gap. In order to do this the pole piece should present a reluctance very low compared with that of the gap, so that the pole piece contains the flux as far as possible and distributes it to the gap. The uniformity of gap reluctance (the accuracy with which it is made) will determine the uniformity of the field in the gap.

Two types of focusing adjustments are in general use. The variable-shunt type bridges part of the magnetic circuit, thereby reducing the flux available in the pole pieces. Such a device should operate to reduce the field uniformity

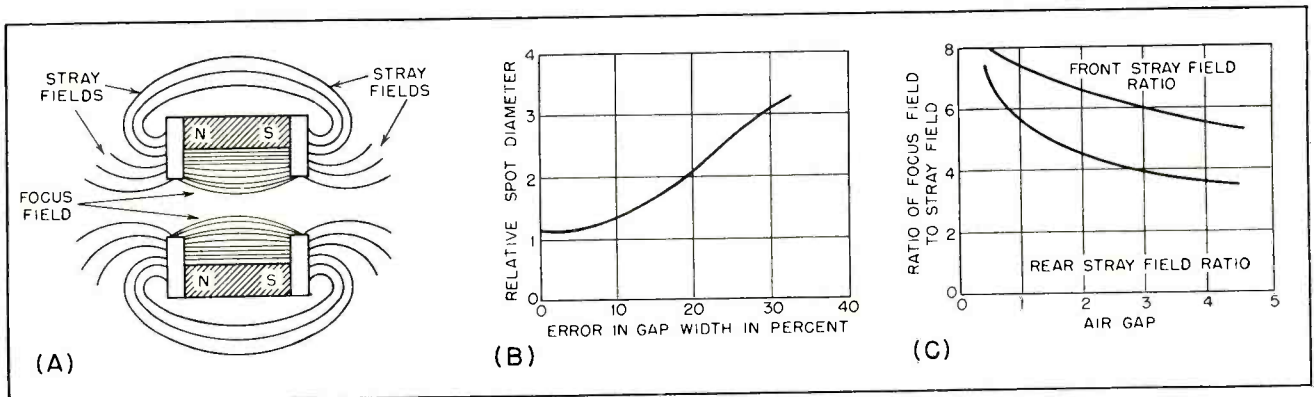

FIG. 2—Origin of stray fields is shown in drawing A. Dependence on gap sizes is illustrated in the curves of B and C

around the circumference in order to ensure that there is a minimum of disturbance of the distribution in the pole pieces. In the variable-gap type the reluctance of the gap, and therefore the field strength, is changed by changing the path length of the gap. These devices tend to increase the leakage field at some position of their operation.

The centering device may move one of the pole pieces in a direction perpendicular to the tube axis, or may be a small secondary movable pole piece. In either case the object is to distort the field so that its axis is no longer parallel with the axis of the beam. As far as practicable this should be done without modifying the field in any other way.

### Possible Imperfections

In discussing the effect on focusing due to the various types of imperfections found in p-m focus units, it is important to consider the type of picture tube used. In general, direct-view picture tubes fall into two classes as far as focusing is concerned. These are the long-necked tubes such as the 16RP4 and the short-necked tubes such as the 16GP4. In the case of the short-necked tubes, the deflection and focus components are crowded closer together and the difficulties caused by stray field effects are greatly increased. The effects of these imperfections are as follows:

If the pole pieces are of sufficiently low reluctance and if the magnets are well distributed, the uniformity of the field will depend entirely on the accuracy with which the gap is made. Results of measurements made on a narrow-gap magnet having heavy pole pieces, one of which could be moved to give

distorted gaps, are plotted in Fig. 2B.

If the magnets in a focus unit containing several pieces of magnetic material are not of equal strength, the effect on the size of the spot depends largely on the ability of the pole pieces to redistribute the flux at the pole faces. When one magnet unit out of three in a p-m focus unit was reduced in strength in each of the following types, the degree of defocus was as follows:

Type of Focus Unit	Normal Spot Size Diameter	Unbalanced Spot Size Diameter (Relative)
(a)	1.0	1.2
(b)	1.0	1.9
(c)	1.0	1.3

In the above table the p-m units used had the following construction: (a) An internal sleeve type of focus magnet with massive pole pieces operated below saturation. (b) An external sleeve type with light pole pieces operated near saturation. (c) An external sleeve type with massive pole pieces well below saturation.

### Field in Trap and Yoke Regions

An effort was made to evaluate the seriousness of the effect of stray fields on the ion-trap system. These stray fields were observed on tubes set up in the chassis previously described. The strength of the stray fields was due entirely to the type of p-m focus unit used. These fields were measured at one inch from the rear face of the magnet, on the axis of the magnet, and one inch from the rear face of the magnet and one inch from the axis of the magnet. The results are listed in Table I.

Increasing the size of the gap in the system increases the path

length and therefore the magnetic reluctance of the gap. This has the effect of increasing both the effective focus field and the stray field, though not at the same rate. This is particularly true when the gap is small.

Figure 2C shows the relationship between the stray and useful focus fields when measured on a variable-gap type of focus unit.

Measurements similar to those described above were made on the same focus units in the direction of the yoke. The results are also listed in Table I.

Using a unit of the type mentioned above, measurements were made to show how the magnet strength required for good focus varied with air gap. It was shown that increase of gap from 0.1 inch to 0.4 inch caused a decrease of about 40 percent in the magnet strength required; the decrease is approximately linear.

### Summary of Results

Good uniformity of focus field in the gap of p-m focus units is essential for good focus. To secure this, units must be constructed solidly, must have pole pieces of good mechanical design and accurate construction and the pole pieces must operate at flux densities below saturation. The magnets forming the p-m focus unit must be well balanced.

The leakage field from the ends of permanent-magnet units is higher than that encountered in most electromagnetic units and may cause severe interference with the operation of both the ion trap and deflection yoke. This is particularly true when short-necked tubes are used.



# A Modern Frequency

Riverhead equipment is prototype of a commercial service available to whole industry to fulfill legal requirements of FCC. Of particular interest are techniques giving basic accuracy of better than 2 cps from 15 kc to 26 mc. Broadcast measurements can often be made to 0.2 cps using a tape-recorder technique

By HAROLD A. TAYLOR and ELLIOT C. RUNDQUIST

*RCA Communications, Inc.  
Riverhead, N. Y.*

GOVERNMENT policing of radio-frequency channels extends to all users, great and small. However, many companies and individuals find it impossible or impracticable for economic reasons to establish their own frequency-measuring facilities external to normal transmitter controls. On this account, those facilities originally established by RCA Communications for monitoring its own circuits have since been expanded into a commercial frequency-measuring service.

As the art progressed, the temperature-controlled wavemeters of early days have been supplanted by modern crystal-controlled equipment. Primary receiving stations are located at Riverhead, N. Y. and

Point Reyes, Calif. Equipment delivered to Manila just prior to the Japanese invasion was destroyed, but the Manila, P. I. station is once again near completion. This article describes the latest equipment and methods in use, supplementing those techniques previously described.<sup>1</sup>

At first the service expanded most rapidly in the broadcast field. With two frequency-measuring locations in the United States and proper time scheduling, adequate coverage could be provided for the entire country.

As additional types of radio usage were established, requests were received for equivalent frequency-measuring services with the result that measuring facilities

were expanded to cover aircraft radio, police radio, short-wave broadcasting, frequency modulation, television, and many other fields.

## Equipment Summary

The basic equipment required for establishing a practical frequency-measuring service can be grouped in a number of separate categories. The installation must provide antennas of many types covering an extremely wide frequency range with directivity and adequate signal pickup to permit proper reception of the various frequencies being measured. The control of directive pattern is extremely important in determining the ability to receive one transmission among several that may be simultaneously active on the same or closely adjacent frequencies. After the signal has been abstracted from the air by means of proper antenna facilities, it is then necessary to provide receivers covering the frequency range required to tune in the desired signal. Within the basic receiving system, provision must be made for the comparison of the frequency being measured with a primary standard of frequency. These primary standards must have necessary auxiliary equipment, to permit their calibration and comparison with other standards. Complementing the measuring equipment, there

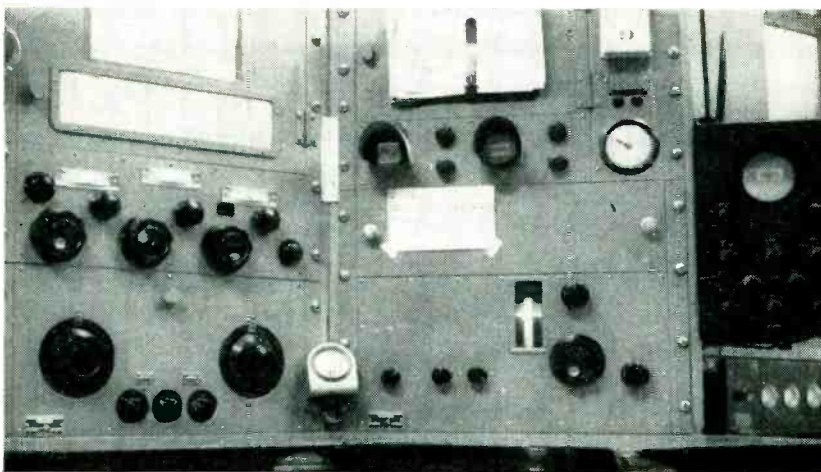

Main measuring position covers the frequency range from 100 kc to 26 mc. Other units are rack mounted above and to left

# Measuring Installation

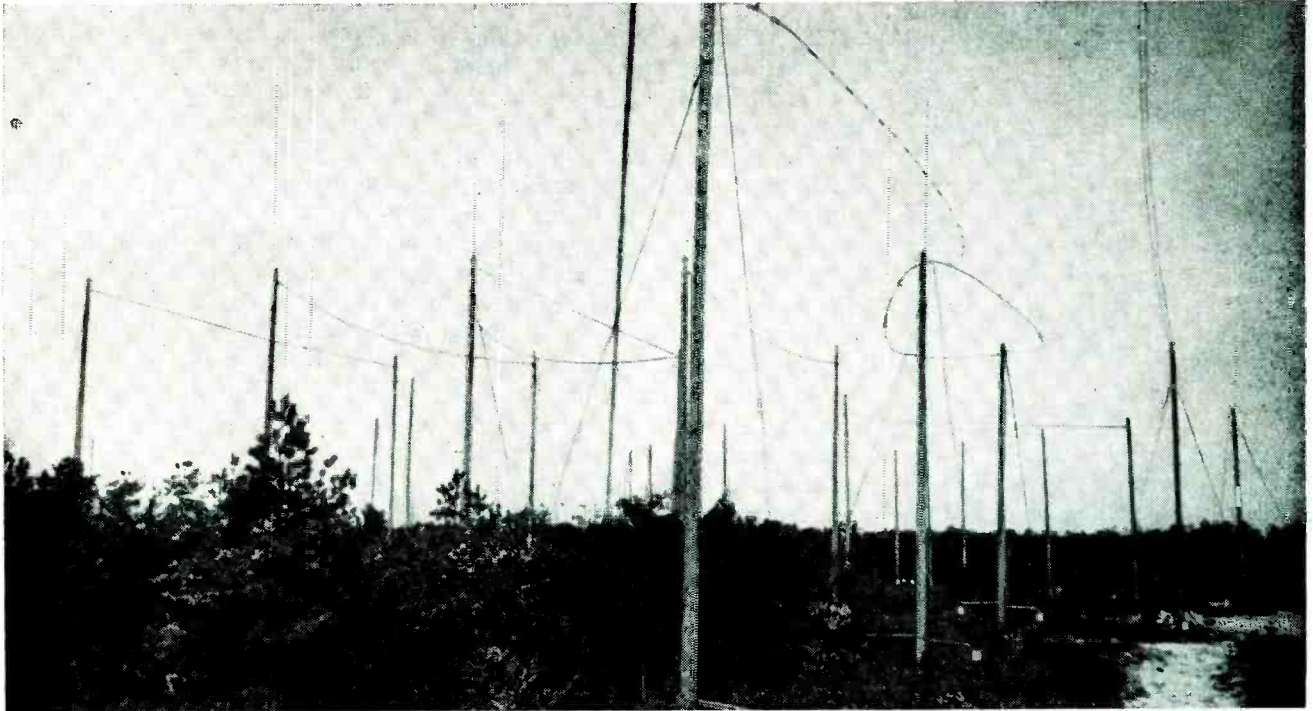

The frequency-measuring antenna field at Riverhead, Long Island

must be suitable monitors to permit identification of the signal being measured. In considering these items of equipment, the laboratory at Riverhead, New York will be described because that location is one of the most completely equipped and accurate frequency measuring locations available for commercial service in the world.

## Antennas

To serve the vlf and l-f classifications of emission three Beverage wave antennas are provided. These antennas range from 7 to 9 miles long and are directed roughly toward Europe. Provision is made for taking energy from either end of each antenna thus permitting unidirectional reception from either of two opposing directions. Each long wave receiver is provided with a combining unit at its input. This unit is equipped with two inputs and one output.

One input feeds directly to the output circuit after amplification, while the second input feeds through a controllable amplifier and

an artificial transmission line. A continuously variable tap on the artificial line is connected to the output circuit. Thus, the second signal can be combined with the first at any amplitude, by control of its amplification, and at any phase angle by control of the tapping point on the artificial line. By combining various combinations of front-end or back-end reception of one or two Beverage antennas, a substantial amount of control over the directional pattern can be had. This control extends from simple combination in-phase to increase the gain and sharpness of the main lobe of the antenna to combinations that produce a reception null at any back or side direction desired.

This arrangement can be advantageous in several ways. Static can be balanced out to a remarkable extent during conditions when the predominant static is being received from one particular direction. Alternatively, if there is an interfering signal from some direction other than that of the desired signal, it can be almost en-

tirely canceled out by proper control of directive pattern.

In the medium-frequency range that includes broadcast activity in this country, three Beverage wave antennas are provided. Each of these antennas is equipped with two transmission lines from which unidirectional reception is obtained from either of two directions 180 degrees apart. Because of this fact, and since the three antennas are constructed in the field on bearings that are 120 degrees apart, choice can be had of directional patterns at 60-degree intervals. Owing to this wide range of choice in directive pattern, it is possible through use of combining units similar in function to those described to cancel out undesired transmissions that are much stronger than the desired transmission and on the same frequency but from a different direction.

To cover the normal short-wave or high-frequency classification from 3,000 to 30,000 kc, several directional fishbone wave antennas are used.<sup>2</sup> These antennas are de-





Frequency measuring building with pole in background supporting group of vhf and uhf antennas

signed for various frequency ranges and are constructed so as to aim in various directions of principal interest. These facilities provide world-wide coverage.

In the very-high-frequency range from 30 to 300 mc and in a portion of the ultra-high-frequency range from 300 to 500 mc a variety of antennas is available. Over the lower portion for the above frequency range, some of the short-wave directional antennas are adequate. Above that point groups of wide-band dipoles are employed. Two groups of horizontal dipoles are provided for reception of horizontally-polarized waves, one for north-south directions and one for east-west directions. One group of vertical dipoles is provided to cover reception of vertically polarized waves. A directional very-high-frequency antenna is provided to cover longer distance reception from the principal metropolitan areas to the west of Riverhead. Consideration is currently being given to providing rotary direc-

tional antennas for this frequency range still further to improve the ability to make measurements at a greater distance.

### Primary Standards

The primary frequency standards, with which signal frequencies are compared, originate in elaborate 100-kc quartz crystal oscillators. The basic oscillator consists of a two-tube positive feedback amplifier in whose feedback loop is placed the quartz-crystal element. The entire oscillator circuit including tubes is mounted in a temperature-controlled box. The box temperature is maintained to within a few hundredths of a degree by means of a mercury thermoregulator. The oscillator is isolated from the utilization circuits by means of buffer amplifiers. All supply voltages are regulated where necessary.

The output of whichever standard is in use drives a series of frequency dividers in such a manner that the various output frequencies are exactly related to the frequency of the primary standard. From these divider chains, output frequencies of 10 and 1 kc are available for frequency-measuring purposes. The 100 and 10-kc frequencies feed harmonic generators that provide an extremely wide band of harmonics of these frequencies throughout the main portion of the radio-frequency spectrum. These signals at 100-kc or at 10-kc intervals, as desired, serve as marker frequencies. The procedure of making a frequency measurement then consists of measuring the frequency separation between the unknown frequency and one of these marker frequencies by means to be described.

A primary frequency standard is defined as one whose frequency may be compared with standard time intervals. The 1-kc output from the divider chain drives a 1,000-cycle synchronous clock that permits a direct comparison between the number of cycles of oscillation of the primary crystal during a period of time against independent astronomical measurements of absolute time. The time of the synchronous clock is compared daily with standard time signals sent out

from the Naval Observatory at Washington, D. C., by means of a recorder accurate to about 0.01 second.

Since comparison of a primary standard with standard time intervals results in evaluation of accumulated frequency drift and may not be indicative of short-term frequency variation, it is necessary to make additional comparative measurements to check the stability of the standard equipment. This is accomplished by two methods. Frequent measurements are made on the standard-frequency transmissions of the United States Bureau of Standards on radio station WWV. The Bureau certifies these transmissions as accurate to better than one part in fifty million.

In addition, arrangements are periodically made for simultaneous measurement of certain radiotelegraph transmitters (whose frequency-stability record is satisfactory and whose frequency is suitable for reception at the interested points) by the Riverhead and the Point Reyes frequency-measuring laboratories—and occasionally at one or more other frequency-measuring laboratories.

### Measuring Receivers

A portion of the main measuring position, which covers a frequency range from 100 kc to 26 mc, is illustrated. Three different r-f tuners are provided, one covering the long-wave range from 100 to 550 kc, one covering the broadcast and adjacent area from 550 kc to 3 mc, and one covering the normal short-wave range from 3 to 26 mc. Any one of the three tuners can be instantly connected to the intermediate-frequency and interpolating equipment of the basic measuring position.

An extensive amount of the equipment shown consists of harmonic and subharmonic generating equipment controlled by the primary standards. These units serve to synthesize a direct frequency-calibrated source of  $1,050 \pm 11$  kc. This adjustable signal is used in a manner to be described for determining the difference of the unknown frequency from one of the marker standard frequencies. The remaining units provide the inter-

mediate frequency and other functions shown in Fig. 1.

In addition to this main position there are available conventional long-wave receivers covering the range from 15 to 100 kc. One of these has been equipped with a converter whose beating-oscillator frequency is obtained directly from the primary frequency standard. This arrangement permits measurement of these low frequencies at the main frequency measuring position.

Several short-wave receivers are available to cover the frequency range from 26 to 500 mc. Measurements in this range are likewise accomplished from the basic measuring position.

### Basic Measuring Method

The block diagram in Fig. 1 shows the basic method used in making frequency measurements. A tuner unit (A) is chosen that covers the proper frequency range for the signal to be measured. The tuner is set approximately by dial calibration to the multiple of 100 kc closest to the frequency of the unknown signal. It is then connected to a harmonic generator that provides marker signals, derived from the primary standard, at 100-kc intervals. The 100-kc marker on which the tuner had

been set approximately is then tuned in. Next, the 100-kc markers are removed by the operator and a series of markers at 10-kc intervals is substituted. The tuner is then shifted toward the unknown frequency while the number of 10-kc markers passed are counted.

When the 10-kc marker nearest the unknown frequency has been reached and tuned in, the frequency of the unknown signal to the nearest 10-kc figure is known. This 10-kc marker is tuned so that its signal output from the tuner is exactly 1,500 kc. The 1,500-kc signal then goes into a monitoring i-f chain (B) where it is mixed with a 1,050-kc frequency generated from the primary source to produce exactly 450 kc. After further i-f amplification, the 450-kc signal is again mixed with a 400-kc frequency that is common to both the monitoring i-f system and the measuring i-f system (C) to produce a signal at 50 kc.

The amplification at 50-kc is provided with narrow bandwidth of about 400 cycles in order to prevent extraneous interference from confusing the oscilloscopic methods of comparison at this point. The 50-kc output is now placed on one set of deflecting plates of a monitor oscilloscope (D) and compared with a locally generated 50-kc reference standard. The tuner is adjusted to make the resulting signal at 50 kc exactly equal the frequency of the reference 50-kc oscillator as indicated by an elliptical pattern on the oscilloscope.

At this point the harmonics are removed from the tuner and an antenna having proper frequency characteristics and directivity is connected. In addition to feeding the monitoring i-f chain, the tuner also feeds the measuring i-f chain. In the first portion of the latter chain a frequency conversion from 1,500 kc to 450 kc occurs by means of an inserted frequency of 1,050  $\pm$  11 kc.

This frequency is developed from the 1-kc subharmonic of the primary frequency standard and harmonics thereof combined with an extremely stable 250-kc oscillator covering a frequency range of  $\pm$  1.1 kc. The block diagram of this interpolation-frequency generator

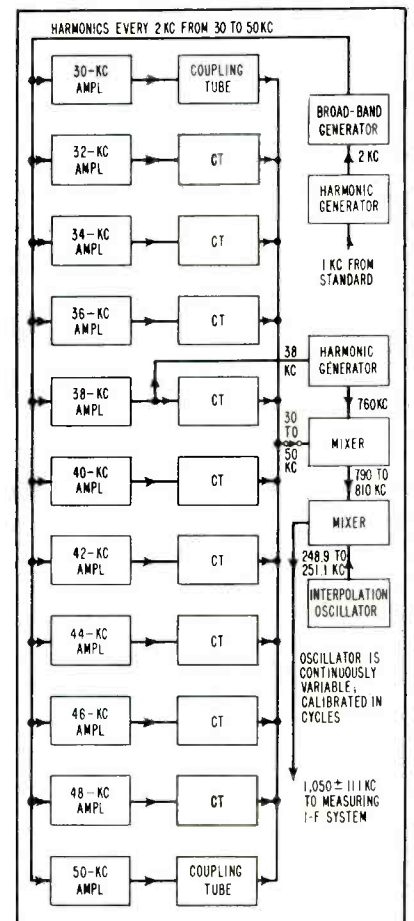

FIG. 2—Method of obtaining the interpolation frequency from the primary frequency standard and a special oscillator

is shown in Fig. 2. The 250-kc interpolation oscillator is accurately calibrated and controlled to produce a direct-reading accuracy with less than  $\pm$  2-cps error. By means of reference against the standard marker frequencies and harmonics of either a 100-cycle or 1-kc frequency derived from the primary standard, the amount of this error may be determined at frequent calibration points and taken into account in the process of measuring to produce an accuracy from this source within about 1 cycle per second throughout its range.

The frequency of the variable 1,050-kc source is now adjusted to the point where the unknown frequency output from the first portion of the measuring i-f chain is exactly 450 kc. This frequency is again converted to 50 kc following which a choice of various bandwidths may be had. The output at 50 kc is fed to another oscilloscope (E) whose other axis is supplied

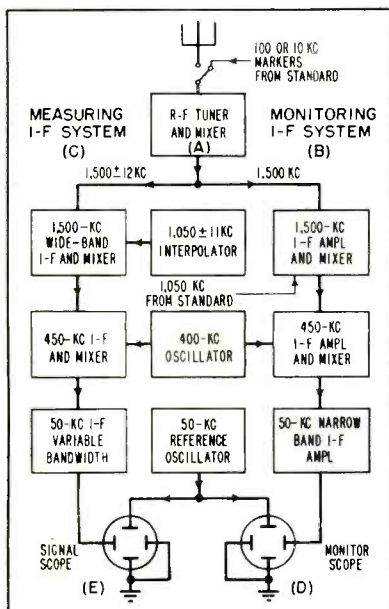

FIG. 1 — Basic frequency-measuring system in which final significant figures are obtained from directly-calibrated interpolation oscillator system



from the same 50-kc reference frequency as supplies the monitor oscilloscope. The unknown frequency is tuned to exact equality at 50 kc with the reference 50-kc oscillator as indicated by the oscilloscope pattern. The tuning is accomplished by adjustment of the  $1,050 \pm 11$ -kc frequency source. Since this frequency source is directly calibrated, the frequency difference between the signal and its nearest 10-kc marker may now be read directly from the controls of the interpolation oscillator assembly. This frequency difference then supplies the balance of the significant figures of a frequency measurement.

Owing to possibility of receiver drift during the course of a measurement, provision is made for simultaneously connecting the antenna and the standard marker frequency source to the tuner. Then both oscilloscope patterns can be observed at one time.

### Extending Frequency Range

The range of the basic measuring system is extended at the low-frequency end from 100 down to 15 kc by use of a standard long-wave receiver covering that frequency range.

The output of this receiver is fed to a balanced-modulator type of heterodyne frequency converter unit whose heterodyne oscillator supply is 400 kc derived by multiplication from the standard. For this purpose, the standard 100-kc frequency is multiplied by 4. The resulting 400-kc frequency is mixed with the unknown frequency from the long wave receiver to produce a resultant frequency in the range from 415 to 500 kc. This output is fed to the basic measuring position and its frequency measured. Accordingly, the frequency of the unknown long-wave signal is that indicated by the measurement minus exactly 400.000 kc.

The extension of the frequency range of the basic measuring position from 26 to 500 mc is obtained as follows. Several uhf receivers are available to cover the added frequency range. A unit is provided that consists of a stable voltage-regulated Hartley oscillator covering a directly calibrated fre-

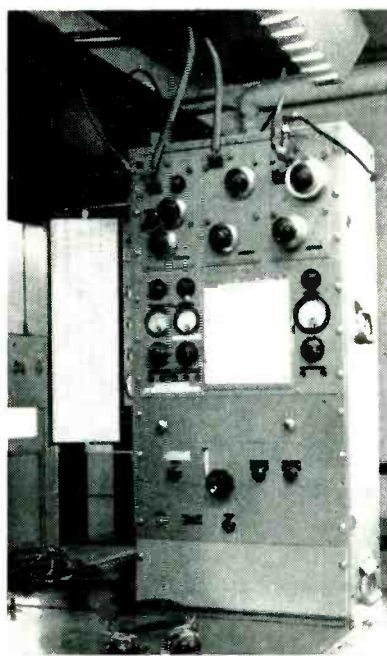

One of the special vhf measuring receivers with the frequency-measuring comparison oscillator below it

quency range of 12 to 20 mc followed by a buffer stage and untuned harmonic generator of the grid-distortion type effective in producing harmonics of the oscillator over the frequency range from 24 to 600 mc.

The measuring process consists of zero beating a harmonic of the comparison oscillator with the unknown frequency to be measured in one of the uhf tuners. The fundamental frequency of the comparison oscillator is then measured by the main frequency measuring position. This measured fundamental frequency multiplied by the order of harmonic used gives the frequency of the signal being measured.

### Accuracy

The average deviation of the primary standard frequency source is approximately 1 cycle in 5 million. Accordingly, a direct frequency measurement without taking account of possible correction factors can be expected to have an error from this source of approximately 2 cycles per second at 10 mc or 5 cycles per second at 25 mc. The basic accuracy of the interpolation system results in a possible error of less than 2 cycles per second at any frequency from 15 kc to 26 mc.

A special technique can be used in handling broadcast measurements and any other measurements whose assigned frequency lies in the immediate neighborhood of a 10-kc marker to eliminate the interpolation error. This method consists of simultaneously receiving the signal being measured and the nearby marker frequency. The resulting beat note between the two frequencies is recorded on a tape recorder together with standard one-second time intervals. Thus, the number of cycles of beat note per second directly gives the frequency difference. The direction of this difference from the marker standard frequency can be obtained by use of the interpolating system. This technique produces a measurement having the full accuracy of the primary standard frequency source. Accordingly, broadcast measurements can result in an overall accuracy having an error of no more than 0.2 cycle per second.

At uhf the basic error of the lower frequency measuring system is multiplied by the order of the harmonic used from the comparison oscillator. Accordingly, an overall accuracy of frequency measurements in this range would show an error of approximately 30 cycles per second at 100 mc or 150 cycles per second at 500 mc.

### Service Range

At vhf and uhf the service range from each measuring location is restricted by propagation conditions to a distance of from 200 to 500 miles depending on relative antenna heights, intervening terrain and transmitted power. Every effort is made to extend the service range of these higher frequency classifications by providing the maximum practical height of receiving antennas together with extreme sensitivity of the associated tuner units.

Through the remainder of the frequency spectrum the RCA frequency-measuring stations provide essentially world-wide coverage.

### REFERENCES

- (1) H. O. Peterson and A. M. Braaten, The Precision Frequency Measuring System of R. C. A. Communications, Inc., *Proc. IRE*, p 941, June 1932.
- (2) H. H. Beverage and H. O. Peterson, Diversity Receiving System for Radio Telegraphy, *Proc. IRE*, p 531, Apr. 1931.

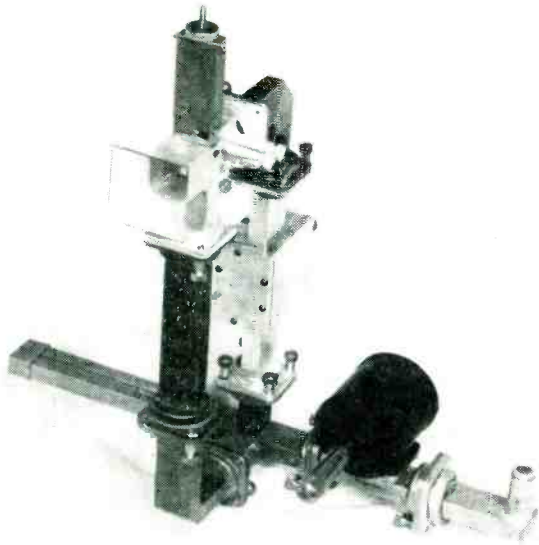

Airborne antenna circuitry for arbitrary polarization

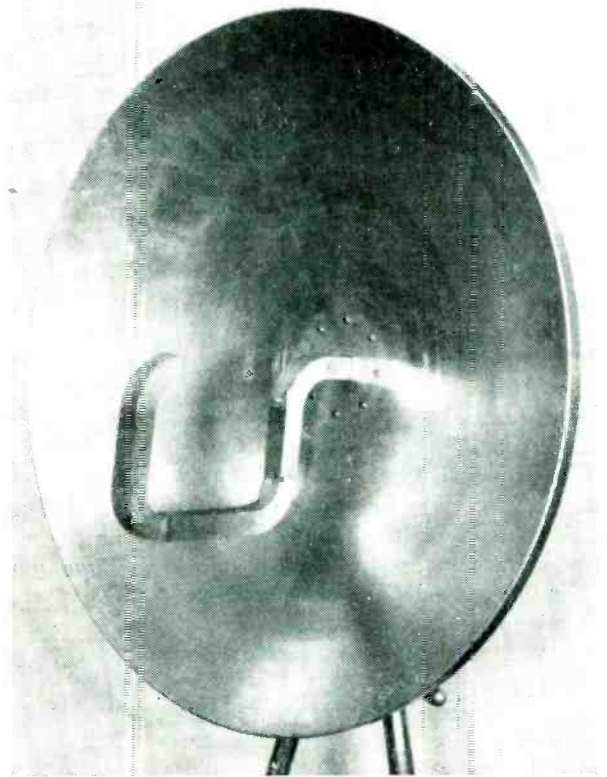

Paraboloid used in 3.2-cm equipment. Note square waveguide

# Microwave Radar Antenna

Special design permits transmission and reception of any specified polarization in search radars, including linear and circular as special cases. Antenna can receive, separately and simultaneously, both transmitted polarization and its cross-polarized component

**E**LIMINATION of certain unwanted radar target reflections is made possible through the analysis of reflected radiation polarization by circular and linear components. In principle this analysis could be accomplished with a plurality of antennas designed to transmit or receive the various polarization components. In practice, however, limitations on space and equipment make it highly desirable to use a single antenna design that is capable of application over a wide range of frequencies. The antenna design described here has the property not only of receiving the transmitted polarization, but also of receiving separately and simultane-

**By HERMAN N. CHAIT**

*Naval Research Laboratory  
Washington, D. C.*

ously its cross-polarized component.

Previously it has not been possible to use a circularly-polarized search radar system with a single antenna used for transmission and reception, since for most targets the reflected wave will have its sense of polarization reversed and thus will be rejected by the antenna. This present antenna design removes such a limitation and so can be used in a search radar system employing circular polarization. Another advantage in this

connection is the possibility of using low power t-r and anti t-r tubes to protect the receiver since receiver and transmitter are on opposite terminals of a hybrid junction.

It is possible to design an antenna with any desired beam characteristics and with either continuously variable polarization or with some chosen fixed polarization. The proper choice of this polarization parameter at a given time may greatly increase the utility of present-day radar systems.

## **General Principles**

Figure 1 is the block diagram of a system that establishes its polarization characteristics in the r-f



transmission line rather than in the antenna proper, and is therefore capable of rather general application. On transmission the power is divided into two equal components in a hybrid junction, the phase of one component is adjusted relative to the other, and then the two components are recombined in space quadrature in the antenna feed line. Any ellipticity of polarization is achievable with this arrangement. Circular polarization requires a  $\pm 90$ -degree phase difference between components; linear polarization a 0 or 180-degree phase difference; other ellipticities, other phase differences. The antenna feed line may then be terminated in a variety of antenna designs.

On reception the r-f circuitry permits both the component identified with the transmitted polarization and its cross-polarized component to be received on two receivers simultaneously. The cross-polarized component is here defined with reference to the transmitted signal. These two components have the same ellipticity ratio, the major axis of their polarization ellipses orthogonal, and their instantaneous E-vectors rotating in opposite senses.

The ability of this system to transmit circular polarization of one sense and then to receive both senses of circular polarization separately and simultaneously is shown in Fig. 2. A generator, furnishing a voltage  $V/0^\circ$ , is placed at the right-hand terminal of the hybrid junction (Fig. 2B), which is a magic tee. For purposes of explanation, another generator fur-

nishing no voltage is assumed at the left-hand terminal. Therefore, equal voltages of  $0.7V/0^\circ$ , in time phase with each other, will appear at equal path distances in the E- and H-plane arms of the magic tee. By adding 90 degrees of phase change to the E-plane path, and arranging the two input terminals to the square waveguide so that they are perpendicular to each other, two voltages equal in magnitude and in time and space quadrature will appear at the antenna. The signal that is radiated will therefore be right-hand circularly polarized. Similarly, a left-hand circularly polarized signal can be radiated merely by interchanging the two generators, or by adding

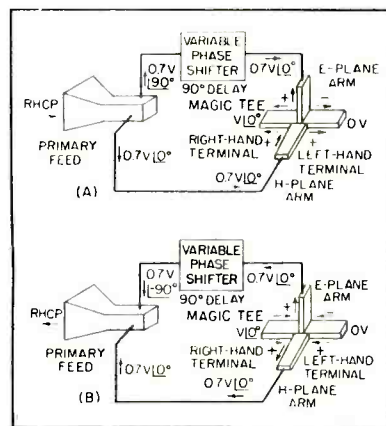

FIG. 2—Reception (A) and transmission (B) of right-hand circular polarization are illustrated

another 180 degrees of phase change to the E-plane path.

### Reception

Upon reception, the right-hand circularly-polarized component of the incident field induces a voltage at the vertical terminal of the waveguide which is equal in magnitude to, and leads in phase by 90 degrees, the voltage induced at the horizontal terminal. Due to the phase shifter, the two voltages arrive at the E- and H-plane arms in phase and are therefore detected at the right-hand terminal of the magic tee as indicated in Fig. 2A. In like manner the left-hand circularly polarized component of the incident field is received at the left-hand terminal.

To use this same antenna to

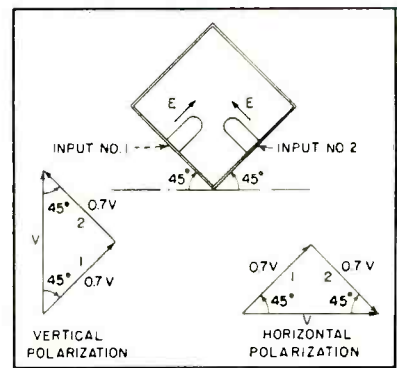

FIG. 3—Operation of antenna when used to transmit and receive linear polarization

transmit and receive linear polarizations, it is necessary that a 0 or 180-degree phase shift be introduced between components. If horizontal and vertical polarizations are desired, the antenna must be so oriented that the input terminals make angles of 45 and 135 degrees with the ground as shown in Fig. 3. Any arbitrarily chosen elliptical polarization can be transmitted and received by a proper adjustment of the phase shift and rotation of the antenna feed.

Whatever component is generated, the component received at the generating terminal of the hybrid junction has the same polarization characteristics as the transmitted signal. For radar type of operation, assuming a single reflection of the transmitted signal from the target surface, the transmitter and receiver of a given linear component are located at the same terminal, whereas the transmitter for a circular component and the receiver for the reflected circular component are located at different terminals of the hybrid junction. It is this fact which excludes the use of circular polarization in radar systems having antennas with one terminal only.

### Design Criteria

It was assumed in the previous sections that the transmitted power was divided exactly equally between the two arms and that the two path lengths differed by exactly 90 degrees or by 0 degrees or 180 degrees for circularly or linearly polarized components respectively. In practice a tolerance is put on the

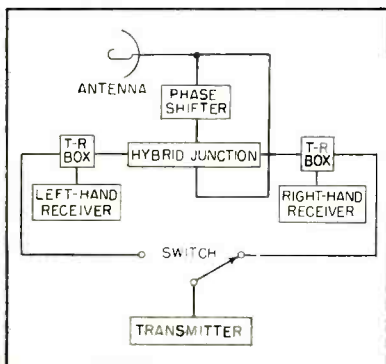

FIG. 1—Block diagram of system that establishes polarization characteristics in the r-f transmission line rather than in antenna proper

polarization characteristics, and it is therefore necessary that design criteria be established. Those for circular polarization are discussed here.

Let the two orthogonal linear components of an electromagnetic field be represented as

$$\begin{aligned} E_x &= A \cos \omega t \\ E_y &= B \cos (\omega t + \phi) \end{aligned} \quad (1)$$

where  $A$  and  $B$  are the amplitudes of the components and  $\phi$  the phase angle between them. Then the power ellipticity of polarization can be written

$$e^2 = \frac{P_{\max}}{P_{\min}} = \frac{A^2 + B^2 + \sqrt{(A^2 + B^2)^2 - 4A^2B^2 \sin^2 \phi}}{A^2 + B^2 - \sqrt{(A^2 + B^2)^2 - 4A^2B^2 \sin^2 \phi}} \quad (2)$$

where  $P_{\max}$  and  $P_{\min}$  are proportional to the squares of the major and minor axes of the polarization ellipse of this field. When  $A$  is equal to  $B$  and only  $\phi$  is allowed to

vary, Eq. 2 becomes

$$\frac{P_{\max}}{P_{\min}} = \cot^2 \frac{\phi}{2} \quad (3)$$

For values of ellipticity near circular it is convenient to express the power ellipticity as  $P_{\max}/P_{\min} = \cot^2 \left( \frac{90^\circ + \Delta\phi}{2} \right)$ , thus showing the deviation of the ellipticity from unity directly in terms of the deviation of  $\phi$  from 90 degrees. Figure 4A is a plot of this relation.

If on the other hand  $\phi = \pm 90$  degrees exactly and the amplitudes of the components are allowed to vary, Eq. 2 becomes

$$\frac{P_{\max}}{P_{\min}} = \left( \frac{A}{B} \right)^2 \quad (4)$$

Figure 4B is a plot of Eq. 4.

### Measurement of Ellipticity

It is possible to resolve any electromagnetic wave uniquely into the sum of two circularly polarized fields of opposite senses of rotation and of unequal magnitudes. Therefore, once this antenna system has been set up to receive circular polarization, it is necessary only to measure the ratio of the powers  $P_R$  and  $P_L$  present at the right- and left-hand receivers respectively (Fig. 1) in order to determine the ellipticity of polarization of an incident wave. The power ellipticity in terms of this ratio is given by

$$e^2 = \frac{P_{\max}}{P_{\min}} = \left[ \frac{\sqrt{P_R/P_L} + 1}{\sqrt{P_R/P_L} - 1} \right]^2 \quad (5)$$

Figure 4C is a plot of  $P_{\max}/P_{\min}$  versus the ratio of the powers at the right- and left-hand terminals of the hybrid junction.

### Experimental Results

This design technique is applicable to any wavelength, although the choice of circuit elements is dictated by size or weight limitations. Two such systems have been built, one operating in the 3.2-cm band, the other in the 10-cm band. The two photographs show the 3.2-cm model. The square waveguide used as the transmission line was designed to transmit two  $TE_{10}$  modes at right angles to each other but no higher modes. In other words the inner dimension  $a$  of the square waveguide satisfied the condition  $\lambda/\sqrt{2} > a > \lambda/2$ . Waveguides instead of probe couplings were

used to reduce the crosstalk between the two input lines. The phase shifter consisted of a movable dielectric slab placed inside one of the waveguide sections and was designed to produce a maximum phase shift of 360 degrees.

It was found that these antennas could be adjusted for ellipticities of unity, the limiting factor being the accuracy of the test equipment used.

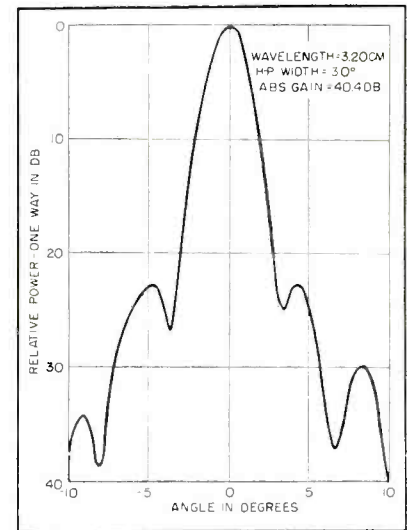

FIG. 5—Power pattern of a circularly-polarized antenna paraboloid 30 inches in diameter

The gain, beamwidth, and patterns of these antennas were consistent with theoretical predictions. For example, one cut through the main lobe of the radiation pattern of the parabolic type antenna shown was measured for many linear polarizations. It was found that the ellipticity of polarization was no greater than one decibel over the entire portion of the main lobe when the on-axis ellipticity had been adjusted to be less than 0.25 db. Figure 5 shows a typical cut.

### Acknowledgment

The author is indebted to L. C. Van Atta and J. I. Bohnert of Naval Research Laboratory and L. J. Chu of Massachusetts Institute of Technology for their continuous encouragement and stimulating consultations. The author also wishes to acknowledge preliminary work on this project done by S. Topol, formerly of Naval Research Laboratory.

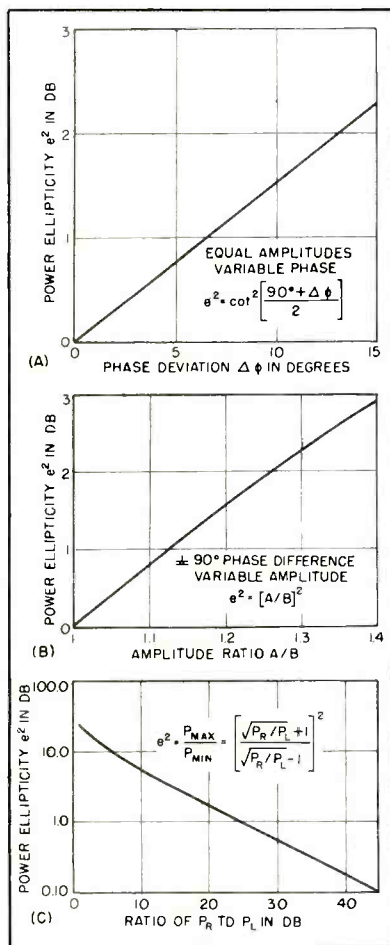
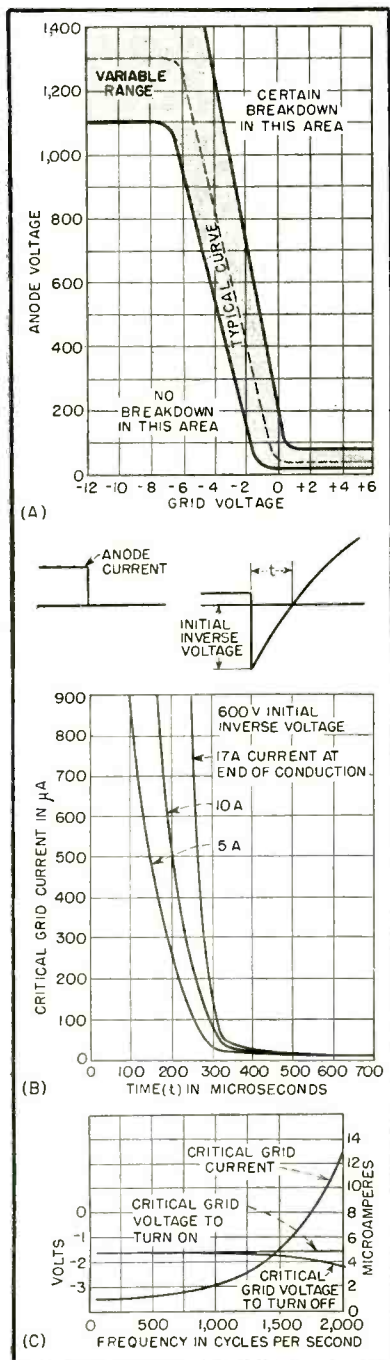

FIG. 4—Curves showing relationship between power ellipticity and other parameters



# THYRATRON

Seven basic methods for control of the firing angle and four primary sources of noise are analyzed, with circuit diagrams and waveforms. Analysis includes criteria for reliable circuit operation based on calculations of maximum critical grid current, interaction, transients and increasing frequency



**I**NERT-GAS thyatron tubes are found today in increasing number and diversity of applications for automatic control systems where compact and reliable amplification is required. The degree of success of each application, industrial or military, depends vitally upon the engineering attention given to the grid circuit.

If a-c voltage is applied to the anode of a gas thyatron, the beginning of current conduction in each cycle can be accurately controlled by the voltage applied to the grid. Most tubes are designed to have a slightly negative grid characteristic to minimize grid drive and for increased stability. As the negative voltage on the grid is decreased at less than some negative value of a few volts the tube will fire and electron flow from cathode to anode will be established. This value of potential is called the critical grid voltage. To assure equipment performance independent of small variations among tubes and over tube life, the circuit designer bases his calculations on the maximum critical grid voltage range for all tubes over the entire useful life and maximum rated ambient temperature range, as shown in Fig. 1A, rather than upon typical curves.

The basic problem in grid circuit design is to convert some quantity

to be controlled into an electrical signal, and to operate on the signal to cause it to shift the firing point of the tube.

Often the parameter to be controlled is available as a voltage—for instance, when regulating a generator or alternator. If position is to be controlled it can be converted into a voltage by using position to move a potentiometer, a synchro, the magnetic armature of an inductance, one plate of a capacitor, a strain gage, or a shutter in a light beam.

In nearly all circuits it is common practice to balance the quantity to be controlled or its voltage equivalent, against a reference of such magnitude that the voltage difference between it and the signal, when applied to the grids, will be large compared to changes in tube critical grid voltage, amplifying the difference if an impractical reference would otherwise be required for the desired sensitivity.

## Basic Methods

The numerous schemes for control of grid firing angle can be classified as modifications of the seven methods indicated in the summary of Fig. 2.

The maximum critical grid current is the greatest value of current that flows to the negative grid just prior to firing as the grid voltage is reduced to fire the tube. This current flows in a direction to make the grid less negative, or in a sense, may be considered to make the apparent critical grid voltage correspondingly more negative than the true critical grid voltage. Since the critical grid current after cycles of

FIG. 1—Maximum range of grid voltage characteristic for type C6JA tubes (A), effect of critical grid current of one type C6M (B), and effects of frequency on critical grid voltage and current for one C1K tube (C). Critical grid-voltage curves are data for 160 v peak a-c anode voltage in a half-wave circuit with resistance load and full-rated anode current

# GRID CIRCUIT DESIGN

By JAMES H. BURNETT

*Electrons, Inc.  
Newark, N. J.*

heavy-current conduction may be greater than on the first cycle, the maximum value, not the pre-conduction grid current, is used in careful circuit design. Most modern tubes have so low a critical grid current at 60 cycles that circuit insulation leakage currents to be expected in usual industrial practice may be the limiting current condition.

In these methods the stability and uniformity of the thyratrons being used will usually determine the minimum practical bias voltages and hence the sensitivity.

Proper impedance matching is important. For example, in the method shown in Fig. 2A, the impedance of the phase-shift network is made low compared with the grid circuit resistance. This precaution avoids distortion and phase shift of the signal through regulation caused by loading. The upper limit of grid resistance is usually set at a value that sufficiently minimizes voltage drop with maximum critical grid current or leakage current flowing through it.

In the various methods described in which d-c bias is required, small selenium rectifiers or compact germanium crystal diodes can be used. A combination of d-c and various lagging a-c rider biases can be obtained from one grid-transformer winding as shown in Fig. 3.

Self-rectified current in the grid circuit provides a useful form of d-c bias from a small bypass capacitor across the grid resistor (Fig. 2G).

Self-rectified grid current can be used to provide a stabilizing effect when used with a variable-magni-

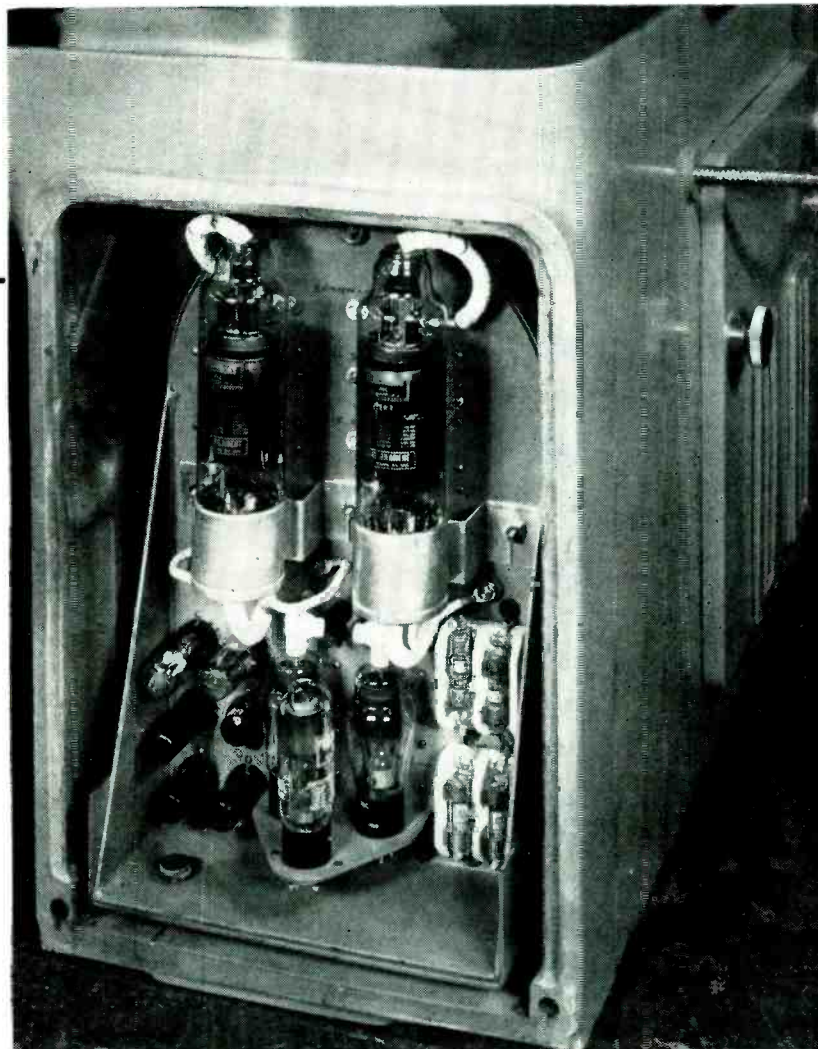

Electron-tube control unit used in Monarch screw machine assures constant speed under load and high torque at low speeds

## INDUSTRIAL GAS TUBES

Thyratrons faithfully control d-c or a-c motor speeds independent of load or line-voltage variations over a range of 500 to 1. In torch-cutter and machine-tool pattern tracers they position servomotors in quick response to the movement of delicate actuators. Performance in the order of 10 inches per minute per thousandth of an inch accuracy is possible.

Uses include shaping fragile parts, pressing automobile bodies, control of huge wind tunnels and delicate repeaters for aircraft and marine navigation equipment. Tubes are found in high-speed or synchronous switching circuits for welders, x-ray contactors, frequency changers, theater lighting and stable power supplies.

Operating in temperatures from  $-60$  to  $+212$  F, and at frequencies in excess of 1,000 cps, thyratrons are dependable when used in the proper circuits, for which the special parameters are described in this article

tude a-c signal. For example, in some closed-cycle systems, the overall time constant may be several cycles while the tubes respond almost instantaneously. Figure 4 shows a variable position servo combining a variable a-c signal with fixed lag-

ging a-c grid bias and incorporating the self-bias scheme. With large error signal the total a-c grid voltage will be large in magnitude and nearly in phase with the anode voltage. By use of self-bias, the first cycle of full conduction results



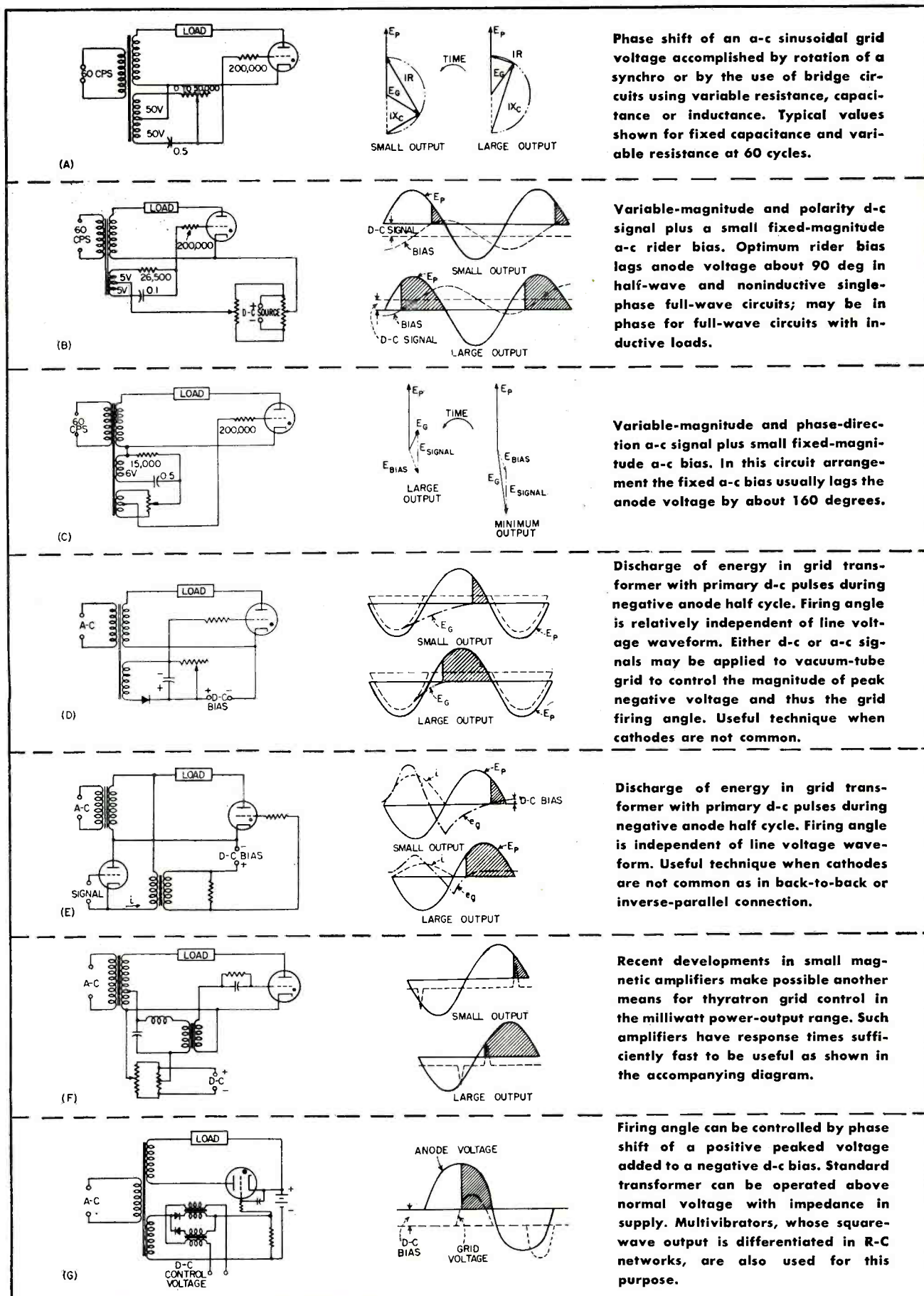

FIG. 2—Seven basic methods of controlling the firing angle of thyratrons

in charging the bypass capacitor negatively. The firing angle on the succeeding cycles will be retarded more than the signal voltage indicates by an amount equal to the negative bias on the bypass capacitor. As this charge leaks off over several cycles, signal sensitivity is gradually regained. The effect is to desensitize the circuit only when signals are large and thereby avoid hunting.

For simple on-off control, the hold-off negative bias may be obtained easily by charging a capacitor between cathode and grid on the negative-anode half-cycle with a small a-c bias 180 degrees out of phase with the anode voltage as shown in Fig. 5.

### Interaction

Sometimes during a conduction period the grid of the conducting tube tends to float at a potential within a few volts of cathode potential. As a result grid current usually flows through the grid circuit during this period. This current may store energy in a grid-circuit component. If the stored

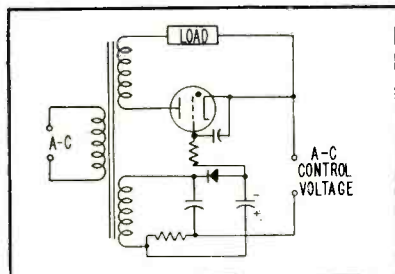

FIG. 3—Method of obtaining combination of d-c and various lagging a-c rider biases

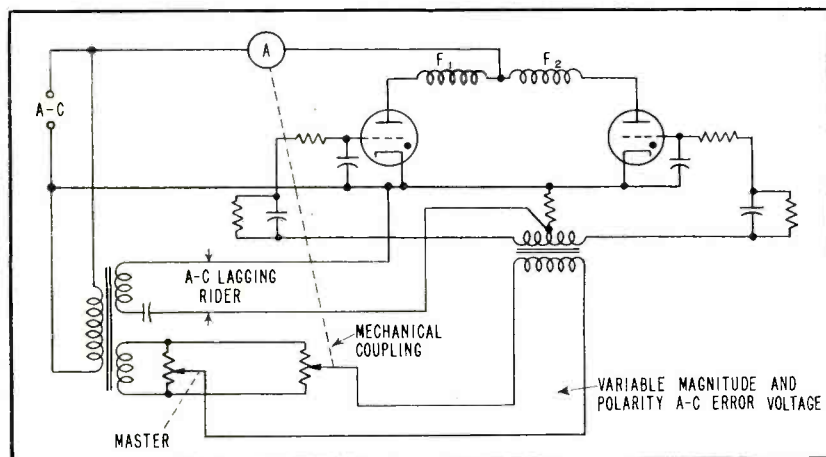

FIG. 4—Self-bias for stabilizing with variable magnitude a-c grid voltage in split-field motor positioning servo

## FOUR SOURCES OF NOISE VOLTAGE

(1) A common, and often overlooked source of noise voltage is transient charging or discharging of stray capacitance between grid transformer windings, and between these windings and ground through high grid-circuit impedance. Voltages of extremely large magnitude and short duration are produced on the grid. A typical offender is the back-to-back connection in which the cathodes are exposed both to line and load potential surges. Figures 7A and 7B show thyratrons so connected for a reversing servo, x-ray or welding contactor, or for lighting control. This effect also is found in servos where the forward and reverse circuits are linked by stray capacitance across grid transformer windings as in Fig. 7C.

Consider conditions existing with a slightly inductive load at the end of conduction of one tube in Fig. 7A. Conduction continues beyond the end of the cycle for a few degrees owing to load inductance. The cathode-to-anode voltage across this tube suddenly changes from tube voltage drop of about 10 volts, to the instantaneous line voltage. A charging current then flows into the stray capacitances indicated, through part of the grid-circuit impedance of the other tube, producing a large voltage of short duration. The actual grid voltage is raised above the critical grid voltage, and the tube misfires.

Such effects can be eliminated by static shields around each grid-transformer winding connected to the respective thyatron cathode. Without shields, a small capacitor across the grid-transformer secondary, or the use of lower-impedance grid transformers, often reduce such noise.

(2) An obvious trouble, though not the most common, is the instantaneous collapse of a-c grid voltage due to commutation of anode current from one tube to another in an adjacent electronic power unit on a common supply line with poor regulation. The inrush magnetizing current when large transformers are switched on the supply line may also produce similar effects.

Correction of such difficulties usually is accomplished by low-pass filtering of the a-c grid voltage. Often the connection of a relatively small capacitor across the grid transformer is adequate and has negligible effect on phase shift of the signal voltage.

(3) Transient noise voltages are sometimes introduced on the grid through capacitive coupling of grid-circuit wiring. Short grid leads are always advisable. It is especially desirable to connect the grid resistor as close as possible to the tube. Shielded conductors connected to the respective thyatron cathodes, rather than to ground, may be necessary. Circuit noise may arise from various possible cathode-to-ground voltages on an ungrounded chassis.

(4) Transient grid voltages induced through interelectrode capacitances in the tube (Fig. 7D) may be limited to a negligible value by connecting a small padding capacitor of 0.005  $\mu$ f or less directly from grid to cathode. Such a circuit results in an effective anode-to-grid/grid-to-cathode capacitance ratio of several hundred. The maximum grid voltage transients are thereby limited to a small fraction of a volt. The time constant of padding capacitor and grid resistor is limited to a fraction of a cycle, minimizing carry-over effects

energy is dissipated too slowly after conduction ceases, it will appear as a fictitious signal on the following cycle. As a result, the tubes may tend to flicker instead of turn on sharply, to pass several cycles for a grid signal calling for one cycle, or to show irregularity in the control curve. Remedies are usually self-evident once the path of the troublesome current and its storage element have been established.

A tube about to fire may be affected by a flow of grid current to another conducting tube through a grid-circuit impedance common to both tubes. The actual grid voltage of the first tube will be materially affected by the "float" potential of the grid of the conducting tube. This effect can occur in a full-wave rectifier circuit as well as in a reversing servo circuit.

Figure 6 shows a circuit condition in which this effect is advantageous. Self-rectified grid current through one tube and a grid circuit resistance common to the other tube in an inverter circuit produce additional negative grid bias for the second tube.

### Circuit Noise

Thyratrons respond faithfully to the actual voltage on the grid whether it is signal or noise voltage. Probably the most important single consideration in successful grid circuit design is the detection of circuit noise, and its elimination. A cathode-ray oscilloscope with a d-c amplifier is practically indispensable in detecting noise. If the input impedance of the amplifier is



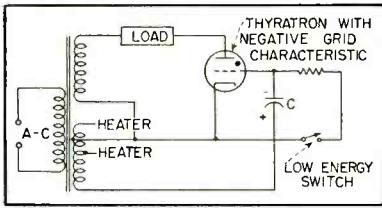

FIG. 5—Simple on-off control is normally held off by self-rectified grid-current charge on capacitor C during negative anode half-cycle

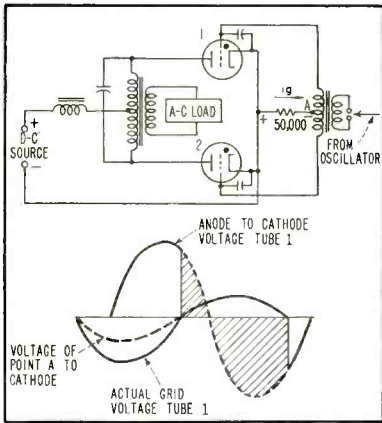

FIG. 6—Inverter circuit utilizing negative bias from common resistor in which positive grid current for another tube flows

many times higher than the grid-circuit impedance, the scope may be connected directly to the grid without upsetting the grid voltage or firing angle. An isolation transformer for the scope power supply will reduce any appreciable capacitance between it and scope ground that may otherwise distort the grid voltage if tube cathodes are ungrounded.

It is often helpful to set the scope for horizontal input sweep, and connect the grid and cathode of the thyatron to one set of plates. The anode and cathode are connected to the other set of plates to obtain a plot of actual grid voltage versus instantaneous anode voltage. Misfiring, when it occurs, is directly apparent.

Noise transients on the grids of position follow-up systems can be detected if the anode connections are opened and the scope watched with brilliance full on during the firing of the reversing tubes.

Sources of noise voltage can be conveniently grouped in four classes shown in the box.

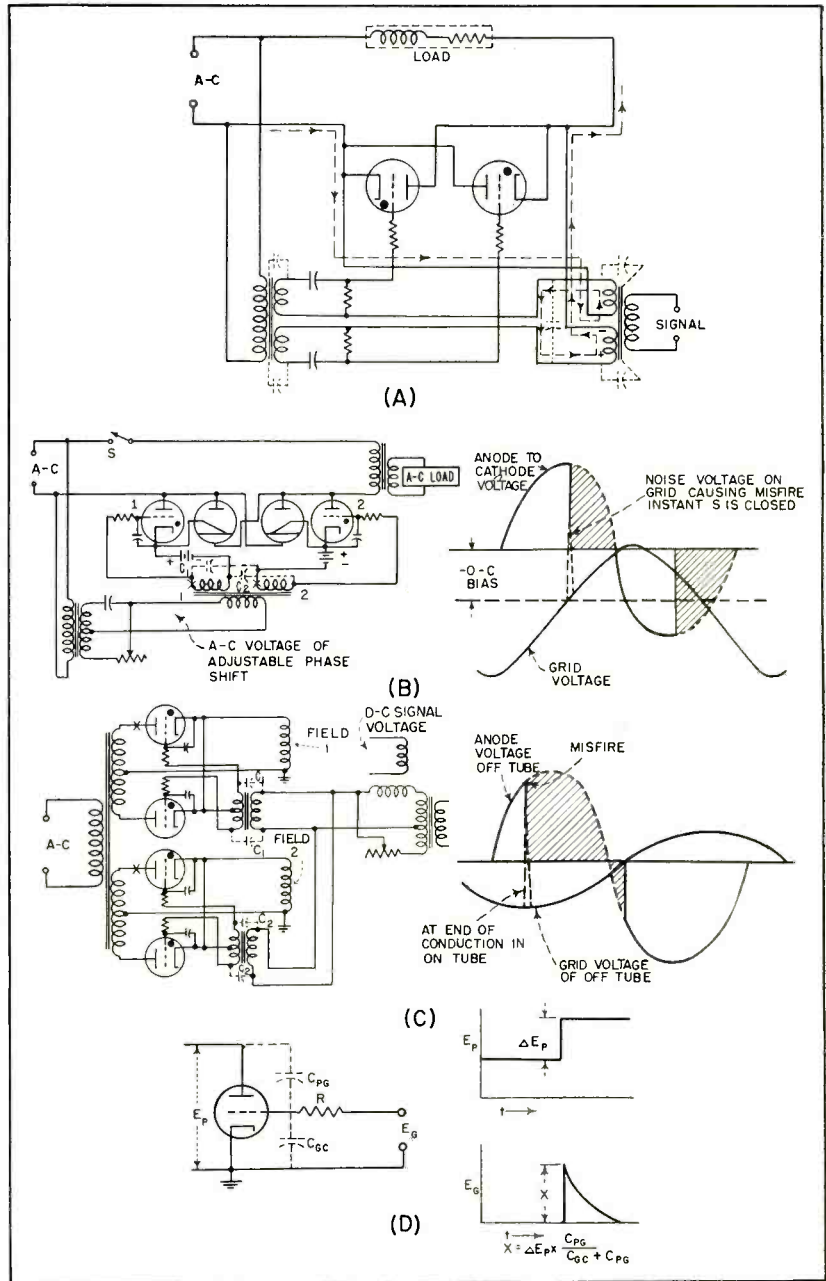

FIG. 7—Positioning servo tubes (A) connected back to back may be affected by charging of stray capacitances. One path of charging current is shown by dashed line. When S is closed (B)  $C_1$  and  $C_2$  charge through grid transformer secondaries 2 and 1 resulting in transients that misfire each tube for one cycle. Current flow (C) through high-impedance transformer produces noise on grids of the off tubes. Effect of interelectrode capacitance with sudden change in anode voltage (D)

There are a number of commonly encountered circuit conditions that may impose a sudden change in instantaneous anode voltage on a thyatron, with resultant undesirable change in firing angle. Rough spots in the control or hunting will result if the designer does not anticipate such circuit characteristics.

Such a condition is found in a full-wave or polyphase rectifier circuit where the load is at least partially inductive and unit operation

covers the range where current in the load may change from discontinuous to continuous current. At this point, shown in Fig. 8, the peak forward voltage applied to the tubes suddenly doubles in magnitude, with resultant sudden change in critical grid voltage. In a closed-cycle control system this condition will result in inherent hunting at such an operating point, unless the designer has provided a grid-circuit voltage that minimizes the effect.

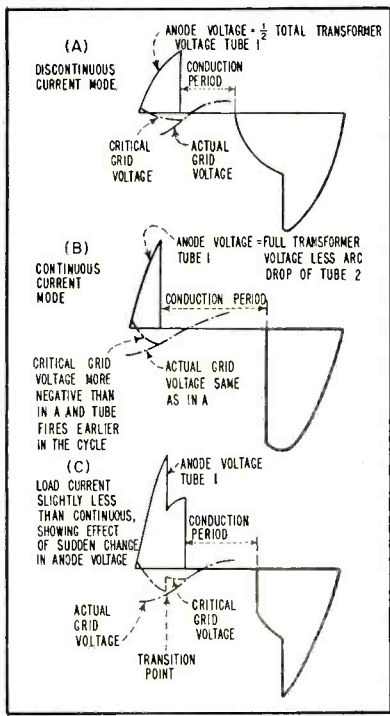

FIG. 8—Discontinuous and continuous load-current operation for full-wave thyatron circuit showing effects on anode and critical grid voltages

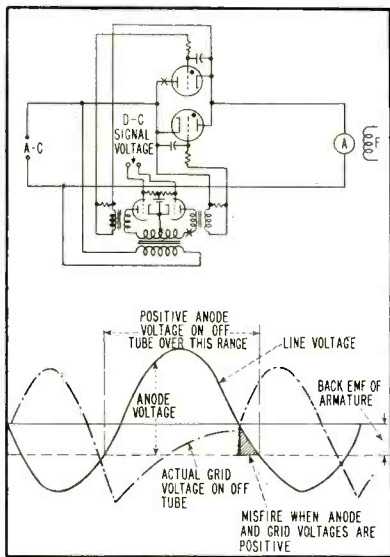

FIG. 9—Effect of voltage generated by the load added to the normal anode voltage in a positioning servo

Another circuit condition that produces a sudden change in critical grid voltage is the double three-phase rectifier circuit with interphase reactor, operating at light load. As the output current is reduced to a low value, the voltage generated in the interphase reactor no longer is great enough to sustain current conduction through each tube for as long as 120 degrees,

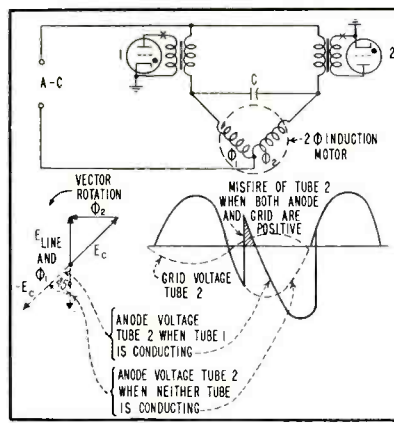

FIG. 10—Effect of phase shift of anode voltage during conduction of reversing tube in one type of a-c motor servo circuit

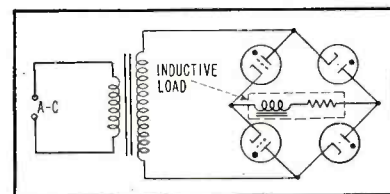

FIG. 11—Single-phase bridge with two thyratrons and two diodes cannot reduce load voltage to zero by grid phase control if load is highly inductive

and the mode of operation suddenly changes from double three-phase (120-degree tube conduction) to six-phase star (60-degree tube conduction) with a resultant sudden change in peak forward voltage and critical grid voltage on all tubes at a given firing angle.

In position follow-up servos employing either d-c armature or field-voltage reversing, the instantaneous anode voltage on the off tube or tubes is the sum of the anode transformer voltage and the voltage appearing across the load as a result of motor rotation or because of conduction of the on tubes. The effect is shown in Fig. 9. It will include any hash from the commutator. In some a-c motor-reversing circuits, the actual anode voltage of the off tube may be the voltage across the phase-splitting capacitor. It is thus of different phase angle (Fig. 10) from the line voltage. In these cases the actual anode voltage may be positive during a large part of the cycle when the anode voltage would normally be negative if the servo-signal voltage were zero. Negative d-c bias in combination with pulse firing is one prevention against

misfiring. Sometimes a disabling bias derived from current flow through one set of tubes can be used to prevent simultaneous conduction in the other set and a resultant short-circuit current through both sets of tubes. At frequencies above a few hundred cycles there is a decrease in available deionization time—especially during transition from one set of tubes to another.

In certain circuits an inherent power-circuit characteristic may cause the loss of tube control which is at first erroneously attributed to faulty grid-circuit design. For example, the single-phase bridge circuit comprising two thyratrons and two gas diodes shown in Fig. 11 supplies a regulated and adjustable d-c output voltage to an inductive load over a wide range. However, the d-c voltage can not be reduced to zero by grid retardation. Analysis shows that one thyatron or the other will conduct at the instant both grids are biased off. Since the voltage generated in the load inductance permits the diodes to commutate the load current each time the supply line voltage passes through zero, the voltage on the anode of the conducting thyatron never becomes negative, and hence conduction of current through it continues. At this point the voltage suddenly jumps to about half output. If it is desired to control a d-c voltage to zero with an inductive load, a single-phase full-wave circuit using two thyratrons or a single-phase bridge using four thyratrons can be employed. A single thyatron may be used with a back rectifier connected across the load.

### Increasing Frequency

As the frequency of the anode voltage is increased above a few hundred cycles, both the time required for the tube to regain control and the effect of frequency on critical grid current and critical grid voltage become important. Usually, the increased critical grid current with increase of frequency, rather than deionization time rating is the dominant factor in setting the grid circuit frequency limit. Typical values are shown for two modern tubes in Fig. 1B and 1C.



# SEMICONDUCTOR DIODES

Summary of characteristics of silicon and germanium crystal diodes, with dimensions and terminal data. Since some ratings are affected by pulse shape, pulse duration and duty cycle, manufacturers should be consulted when working near rated limits in pulse circuits

Table I—Characteristics of Silicon Diodes

Type No.	Design Freq (mc)	Total Energy (ergs)	Peak Pulsed Power (watts)	Max Conversion Loss (db)	Min Fig. of Merit	Max Output Noise Ratio	I-F Impedance (ohms)	Mfr	Shape	Remarks
1N21	3,000	0.3		8.5		4.0	200-800	Sylv	1	First detector
1N21A	3,000	0.3		7.5		3.0	200-800	Sylv	1	First detector
1N21B	3,000	2.0		6.5		2.0	200-800	Sylv	1	First detector
1N21C	3,000	2.0		5.5		1.5	200-800	Sylv	1	First detector
1N22	9,000	0.3					200-800	Sylv	1	Instruments, probes
1N23	10,000	0.3		10.0		3.0	150-600	Sylv	1	First detector
1N23A	10,000	1.0		8.0		2.7	150-600	Sylv	1	First detector
1N23B	10,000	0.3		6.5		2.7	150-600	Sylv	1	First detector
1N25	1,000		6.5	8.0		2.5	100-400	Sylv	1	First detector
1N26	25,000	0.1		8.5		2.5	300-600	Sylv	2	First detector
1N28	3,000	5.0		7.0		2.0	250	WE	1	Mixer, high burnout
1N31	10,000		0.02		55			Sylv	2	High level video detector: 500 cps-5 mc; Z=6,000-23,000 ohms for 1N31; 5,000-20,000 for 1N32. Use 1N31 instead of 1N30.
1N32	3,000		0.36		100			Sylv	1	

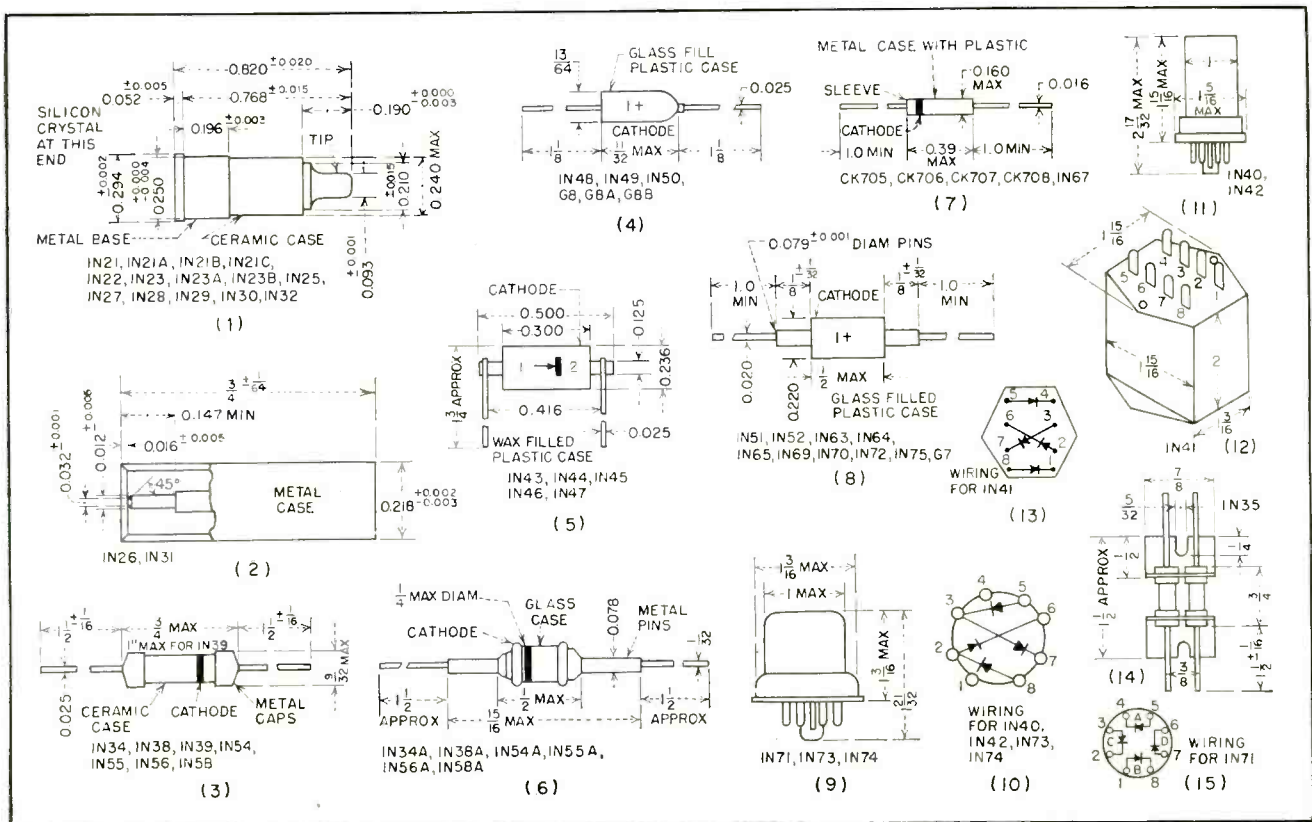

Table II—Characteristics of Germanium Diodes

Type No.	Max Reverse Working Voltage (volts)	Min Reverse Volts for Zero Dynamic Res	Min Forward Current at +1v (ma)	Average Anode Current (ma)	Max Recurrent Peak Anode I (ma)	Max Forward Surge Current (ma)	Max Reverse Current (μa)	Key: <small>(Sylv—Sylvania WE—Western Electric GE—General Electric)</small>		Rayth—Raytheon Obs—Obsolete	Remarks
								Mfr	Shape		
1N34	60	75	5.0	50	150	500	50 at -10v 800 at -50v	Sylv	3		General-purpose diode
1N34A	60	75	5.0	50	150	500	30 at -10v 500 at -50v	Sylv	6		Glass-sealed general-purpose diode
1N35	50	75	7.5	22.5	60	100	10 at -10v	Sylv	14		Matched duo-diode. Ratings are for one diode. Currents match within 10% at forward +1v
1N38	100	120	3.0	50	150	500	6 at -3v 625 at -100v	Sylv	3		100-volt diode
1N38A	100	120	4.0	50	150	500	5 at -3v 500 at -100v	Sylv	6		100-volt diode
1N39	200	225	1.5	50	150	500	200 at -100v 800 at -200v	Sylv	3		200-volt diode
1N40	25	60	12.75 at +1.5v	22.5	60	100	40 at -10v	Sylv	10, 11		Plug-in varistors having four diodes whose resistances are balanced within 2.5% in forward direction at 1.5 volts. Forward resistances of each pair are matched within 3 ohms. Ratings are for single diodes
1N41	25	60	12.75 at +1.5v	22.5	60	100	40 at -10v	Sylv	12, 13		
1N42	50	120	12.75 at +1.5v	22.5	60	100	6 at -3v 625 at -100v	Sylv	10, 11		
1N43		60	5	40	125	500	20 at -5v 850 at -50v	WE	5		WE 400A
1N44		115	3	40	100	400	1,000 at -50v	WE	5		WE 400B
1N45		75	3	40	100	400	410 at -50v	WE	5		WE 400C
1N46		60	3	40	125	500	1,500 at -50v	WE	5		WE 400D
1N47		115	3	30	90	350	4 at -3v 410 at -50v	WE	5		Tested for min rect eff of 35% at 100 mc, 2 v rms input and 5,000-ohm, 20μf load
1N48	85		4	50	150	500	833 at -50v	GE	4		
1N49			4		50		200 at -20v	Obs	4		
1N50			4	25	100	300	80 at -20v	Obs	4		
1N51	50		2.5	50	150	500	1,667 at -50v	GE	8		Utility grade
1N52	85		4.0	50	150	500	150 at -50v	GE	8		High grade
1N54	35	75	5.0	50	150	500	10 at -10v	Sylv	3		High-back-resistance diode
1N54A	50	75	5.0	50	150	500	7 at -10v 100 at -50v	Sylv	6		High-back-resistance diode
1N55	150	170	3.0	50	150	500	300 at -100v 800 at -150v	Sylv	3		150-volt diode
1N55A	150	170	4.0	50	150	500	500 at -150v	Sylv	6		150-volt diode
1N56	40	50	15.0	60	200	1,000	300 at -30v	Sylv	3		High-conductivity diode
1N56A	40	50	15.0	60	200	1,000	300 at -30v	Sylv	6		High-conductivity diode
1N58	100	120	4.0	50	150	500	800 at -100v	Sylv	3		100-volt diode
1N58A	100	120	5.0	50	150	500	600 at -100v	Sylv	6		Glass-sealed 100-volt diode
1N60	25	30		40	150	500	30 at -1.5v	Sylv	3		Video detector diode
1N63	125		4.0	50	150	500	50 at -50v	GE	8		High back resistance and voltage
1N64	20							GE	8		Second detector diode
1N65	85		2.5	50		150		GE	8		D-C restorer diode; 1-sec surge current = 150 ma
1N67	80	100	4	35	100	500	5 at -5v 50 at -50v	Rayth	7		50-volt d-c restorer
1N69	60		5	40	125	400	0.05 at -10v 0.85 at -50v	GE	8		Max temp 70 C. Min rect curr at 40v 60 cps with 500-ohm load is 30 ma. Min rect eff of 1N70 is 35% at 2v rms, 100 mc, 5,000-ohm load and 20μf
1N70	100		3	30	90	350	0.01 at -10v 0.41 at -50v	GE	8		
1N71	40	50	15	60	200	1,000	300 at -30v	Sylv	9, 15		Low-imp varistor matched to pass currents equal within 1 ma at forward +1v. Ratings are for single diode
1N72	5			25	75			GE	8		UHF diode. Noise figure at 500 mc is 14 to 19 db
1N73		75	15 at 1.2-1.7v	22.5	60	100	0.05 at -10v	GE	9, 10		Plug-in varistor with four closely matched diodes
1N74		75	15 at 1.3-1.8v	22.5	60	100	0.05 at -10v	GE	9, 10		Plug-in varistor like 1N73 but wider matching tolerances
1N75	125		2.5	50	150	500	0.05 at -10v	GE	8		High back resistance and voltage. Max shunt C is 0.8 μf
CK705	60	70	5	50	150	500	50 at -10v 800 at -50v	Rayth	7		General-purpose
CK706	40	50		35	125	300	200 at -10v	Rayth	7		Video detector. Rect eff approx. 60% at 54 mc
CK707	80	100	3.5	35	100	500	8 at -5v 100 at -50v	Rayth	7		50-volt d-c restorer
CK708	100	120	3	35	100	500	625 at -100v	Rayth	7		100-volt d-c restorer
G7								GE	8		UHF, design freq 500 mc; max op freq 3,000 mc; noise figure 14-19 db
G8								GE	4		Matched 1N48. Currents match within 10%
G8A								GE	4		Matched 1N52. Currents match within 10%
G8B								GE	4		Matched 1N63. Currents match within 10%





Typical f-m station, one of 13 operated by the Rural Radio Network of Ithaca, N. Y.

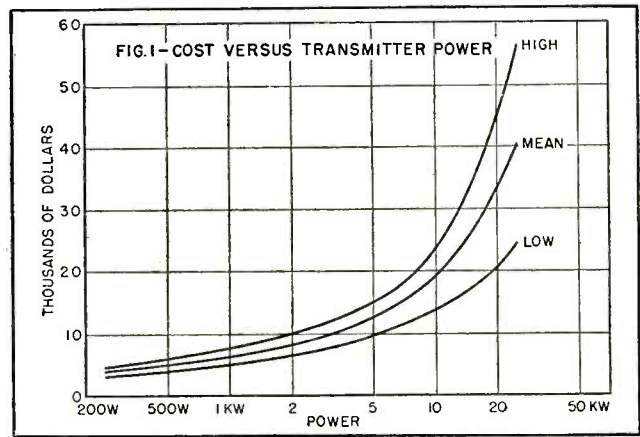

# F-M and TV

By RICHARD G. SINGLETON\*  
*Dept. of Electrical Engineering  
 Massachusetts Institute of Technology  
 Cambridge, Mass.*

THE ENGINEER planning transmitting equipment for a new broadcast station must consider cost as well as coverage. The purpose of this article is to present a practical method of cost analysis for the case of an f-m or television station. A systematic solution is valuable because of the important common factors in these two cases, variable antenna-power gains and line-of-sight transmission.

Because of the frozen status of television applications at the present time and the resulting lack of reliable prices, f-m costs will be used in the examples which follow. However, the reader can readily revise the results when firm tv quotations are available.

## General Approach

In the example to be considered, as in most problems of engineering economics, the costs of the various

major items are interrelated. This type of problem is best solved by successive approximations, as will be demonstrated. Two trials, a quick approximate solution and a careful final one, will usually give sufficient precision.

Consider this problem: *What f-m installation will result in the lowest initial cost per square mile for coverage of rural, level terrain?* Using present-day costs and the FCC's rural coverage standard (50 microvolts per meter) the answer is found to be a 5-kw transmitter, an antenna with a power gain of 12, and a 450-foot tower, giving an initial cost, exclusive of studios, of \$3.80 per square mile.

The mean values of transmitter prices, as shown in Fig. 1, are first considered. The wide spread of prices reflects the present slow market for f-m transmitters.

Because of the practicality of high antenna-power gains with reasonable-sized antennas at f-m and tv frequencies, selection of the

proper antenna is a very important factor in minimizing the cost of a given effective radiated power. For f-m, a side-mounting antenna is usually the best buy unless unusual circumstances indicate the desirability of the more expensive self-supporting, top-mounting type.

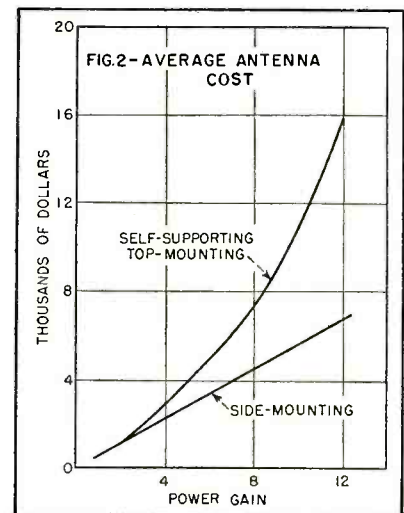

\* Now a student in the Graduate School of Business, Stanford Univ., Stanford, Calif.

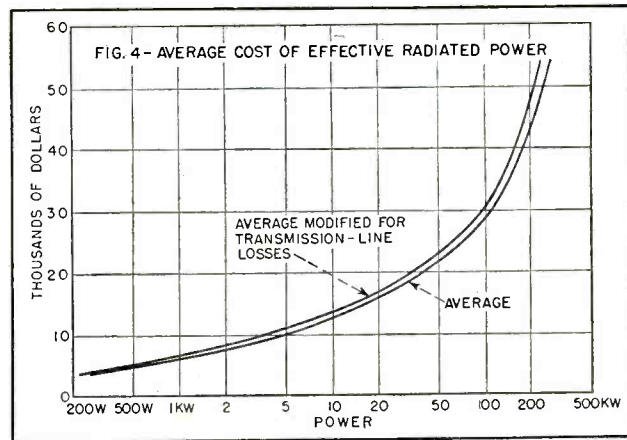
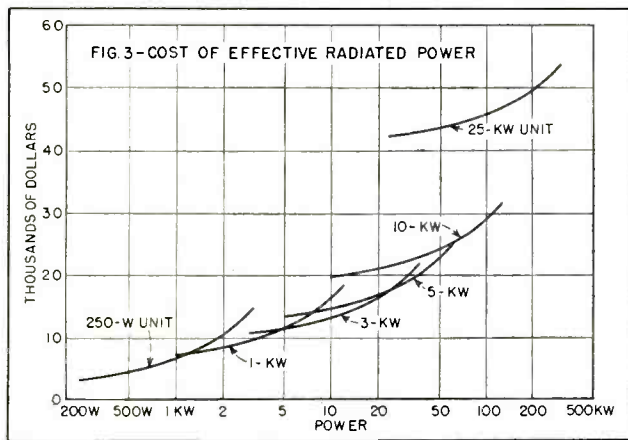

# Station Costs

Investment in dollars, per mile of coverage, is readily estimated by the method outlined. F-M transmitter and antenna prices are used as examples but tv figures may be substituted. Cost of studio equipment is not included

Therefore, side-mounting antenna prices, as shown in Fig. 2, are used in this example. Antennas of both types are available in power gains as high as 12 at present.

Choice of the proper size of transmission line can be made by estimating the cost of the line plus the cost of the power lost in the line for each size of line available. This procedure indicates a 3½-inch line in the present example.

As a first approximation, the cost of obtaining a specified effective radiated power is equal to the cost of the transmitter plus that of the antenna. However, this figure must be adjusted to allow for changes in tower height necessary to maintain the required height at the center of radiation of the antenna. With a side-mounting antenna, the necessary supporting tower height will be increased by one-half the height of the antenna.

When the adjusted effective radiated power is computed using each of the commercially available

transmitter unit sizes, the family of curves in Fig. 3 results. The envelope of these curves, along with a further modification to include transmission line losses, is plotted in Fig. 4.

The selection of the proper type of tower, self-supporting or guyed, is dictated primarily by the cost of land at the station location. For this example it will be assumed that moderate land costs allow the use of a guyed tower. The tower prices shown in Fig. 5 reflect the fact that towers in excess of 450 feet are usually engineered on an individual basis.

## Fixed Costs

For the purposes of this example, fixed costs will be estimated as follows:

Transmitter building .....	\$6,000
Land .....	2,000
Auxiliary technical equipment .....	2,000
<b>Total .....</b>	<b>\$10,000</b>

The family of curves shown in Fig. 6 was constructed by selecting

a particular height to the center of radiation and dividing the sum of the cost components by the area of coverage for each effective radiated power, as computed from the FCC's propagation curves. Working back from the group minimum of \$3.80 per square mile at an effective ra-

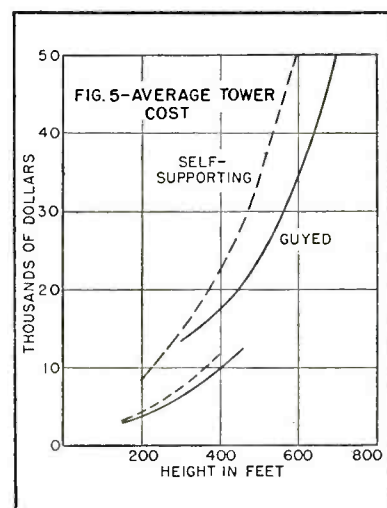



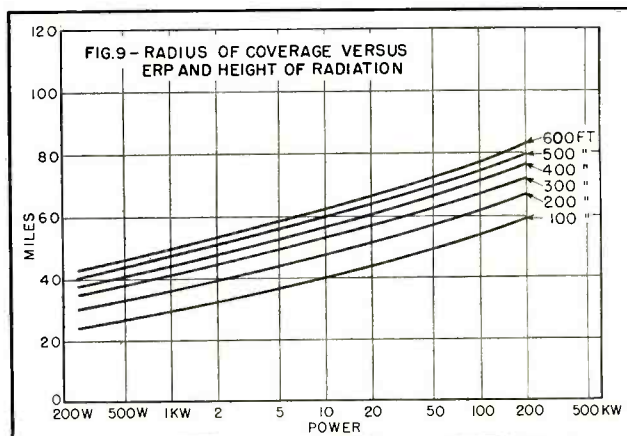
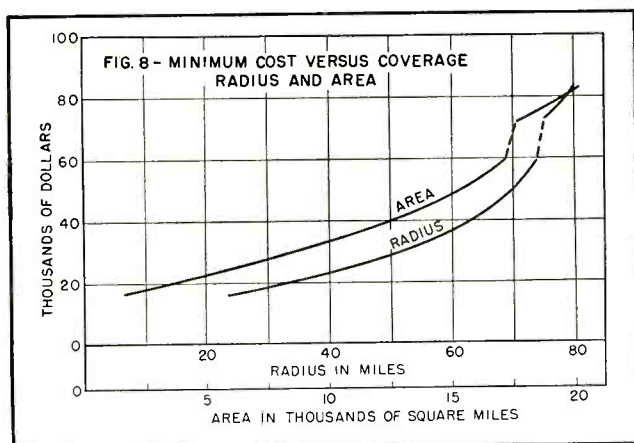
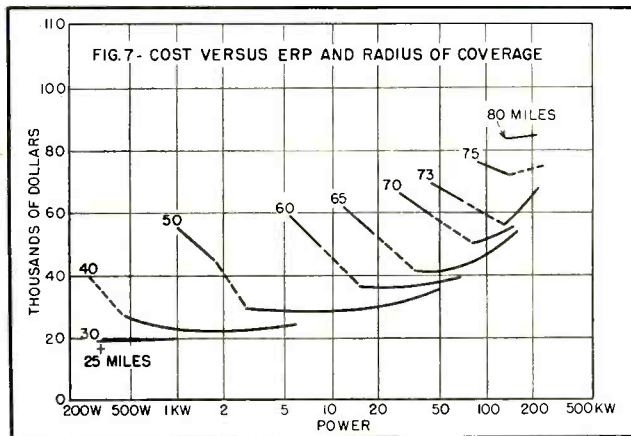
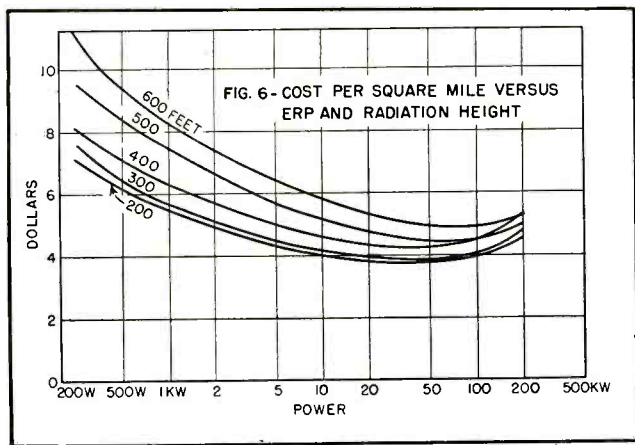

diated power of 50 kw and a radiation height of 400 feet, it is seen that after correction for transmission line losses, 50 kw corresponds to a 5-kw transmitter and an antenna with a power gain of 12. This antenna will require a 450-foot supporting tower to maintain the radiation height at 400 feet.

#### Further Details

The above result would be useful if one were considering the problem of establishing a rural f-m broadcasting network and wished to know the most efficient station size. For an individual station, however, the radius of coverage or area of coverage as a function of cost is probably the most important information required by the engineer.

As an example of the way in which the problem of single-station coverage of level terrain might be handled, the curves in Fig. 7 and 8 have been drawn by rearranging the data from the original example and determining the radius of

the 50-microvolt-per-meter contour from the FCC's curves. The curve in Fig. 8, giving the initial cost of a single station exclusive of studios, results from the minima of the curves in Fig. 7. These curves are discontinuous because of the jump in tower prices at 450 feet.

In the case of a single station, the results can readily be adjusted to include individual peculiarities of the location. If the transmitter site under consideration stands above the surrounding terrain, or if the surrounding terrain is irregular, these factors can be taken into account in estimating the coverage area. Or, if it is intended to mount an f-m or tv antenna on the top of an existing a-m tower, one variable will be eliminated.

Redrawing the FCC propagation curves for the particular value of signal level of interest will speed the process of relating height of radiation and effective radiated power to coverage radius of area. For example, see the curves in Fig.

9, which were used in the preceding calculations.

Of more practical interest than the actual area of coverage of a broadcast station is the number of persons living within this area. The above results can easily be expressed in terms of cost per thousand persons in the area of coverage by relating area to population through population density maps and census data. This type of presentation, when applied to existing metropolitan stations, will in most cases confirm the often-suspected fact that power increases are seldom justified on the basis of increased potential audience. However, the same is not so likely to be true of a rural station.

Due to the wide variations in individual circumstances, the specific results presented here will probably be of value mainly for purposes of rough estimating. However, the method is general enough to allow application to most situations encountered in practice.

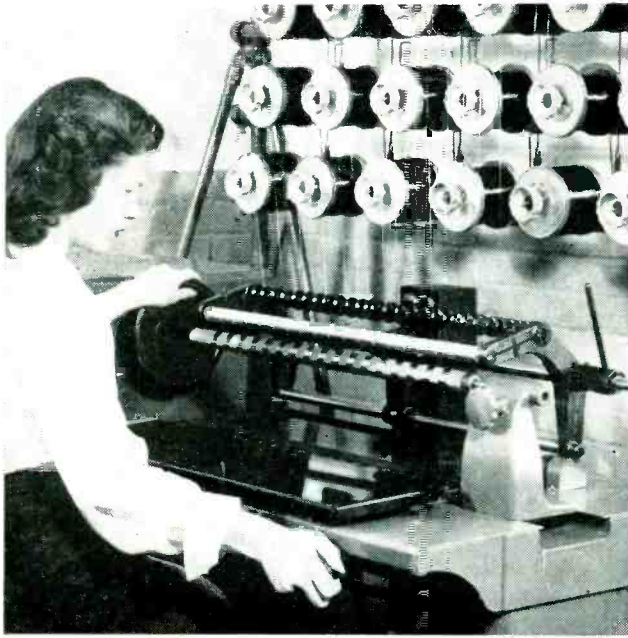

Operator at manual stick winder, controlling spindle speed with left hand while raising paper shelf with right hand

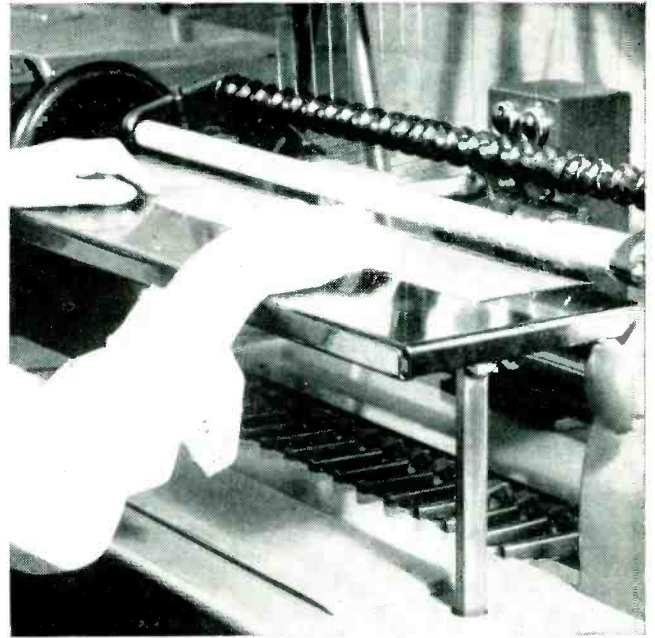

Feeding interleaf sheet into manual machine. Coils being wound on stick are hidden by raised shelf in this view

# Planning Coil Production

Methods of winding reliable universal, interleaf and bobbin coils for electronic equipment, and instructions for constructing a nomograph that shows minimum coil-lot size at which an automatic winder becomes more economical than a manual machine

**E**LECTRICAL COILS, vital parts of any radio or tv set, undergo continual redesign either to improve performance or to cut costs. The decision of the production engineer as to how coils should be wound, what machines should be used, and how the machines should be set up becomes more and more vital as military requirements call for both short and long runs of entirely new coil designs. With the pool of skilled manpower dwindling rapidly, the attractiveness of automatic coil-winding machinery increases correspondingly.

Fortunately, most of the coils used in radio, television and communication receivers use one of the following three types of construction: (1) Universal or lattice-wound coil; (2) interleaf coil; (3) bobbin coil.

By **CARL E. SULLIVAN, Jr.**

*Planning Engineer  
Universal Winding Co.  
Providence, R. I.*

The universal coil is by far the most familiar to the electronic engineer. This coil is recognized by its open, self-supporting structure and the geometric pattern of the multi-strand Litzendraht wire lay. This geometric pattern is the secret of the coil's high Q, high inductance and minimum resistance. Typical applications are for peaking coils, traps and flyback transformers in television receivers.

The interleaf coil, characterized by insulating layers of paper or acetate sheet between layers of wire, is used in power transformers, audio output transformers and filter chokes. It is generally used with a laminated iron or steel core

and for these applications is square or rectangular in shape.

The bobbin coil, least used for radio and tv, is simply a single random winding in a flanged paper or plastic bobbin. Its purpose is to supply a controllable magnetic field, as in the focus coil of a tv receiver.

## **Winding Universal Coils**

Machines for winding universal coils require accurate construction because these coils are self-supporting, depending solely on their construction for strength. The wire must be laid down in an accurate predetermined pattern that varies with the size of the wire, the diameter of the tube and the turns.

The average universal coil contains about 700 turns. As winding machines run between 700 and 1,000 rpm, winding time is seldom



longer than 1 minute. On the other hand, the time required to handle or prepare the coil while on the machine is comparatively long, and each operation must be repeated for each individual coil.

To obtain maximum productivity, the largest coil multiple physically possible should be used. For universal coils, common practice is to wind four in multiple (four coils at a time). An additional advantage of a large coil multiple is that it permits a more flexible choice of speeds. Generally, after removing the completed coils from the machine the operator has a finishing operation to perform on each coil during winding of the next set.

Assuming a unit time for this operation of, say, 30 seconds, the operator would be busy for 2 minutes between sets with a four-coil multiple, but only 1 minute with a two-coil multiple. With the larger multiple, therefore, it is possible to wind at half the speed of the two-coil multiple and achieve the same productivity.

Lower speed is a definite advantage for it reduces maintenance on the machine and improves the quality of the winding by reducing vibration and improving control of wire tension. With high-turn coils, the possibility of one operator handling two machines should not be overlooked.

In a winding machine for universal coils, the cam speed is actually greater than the spindle speed, for the wire goes back and forth across the coil several times per revolu-

tion. To obtain a compact, strong coil a very fine adjustment is required so that with every revolution the crossing point of the wire is either advanced or retarded a small amount to make each turn lock the preceding turn in position. This amount is approximately equal to the size of the wire being wound. The device which controls this spacing is called a gainer. Its correct setting can be determined only by trial and error, for there are so many variables. The gainer adjustment is stepless and permits winding a coil for any degree of compactness, but there is only one setting which will give the electrical and dimensional requirements of any one specification.

### **Manual Interleaf Machines**

In manual winding machines for interleaf coils, the interleaf paper is inserted by the operator at the completion of each layer. In automatic machines, the interleaf paper is inserted automatically by the machine without stopping the arbor. The manual machine is the more popular because it is simpler, more flexible and less expensive. However, each machine has its own merits and field of application.

The manual machine is designed for simplicity, a minimum of adjustments and low cost. Coils are wound in multiples up to thirty on arbor-supported paper tubes 16 to 30 inches long, and wide sheets of insulating paper are inserted by the operator between each wire layer. Upon completion, the stick is

marked, removed from the machine, then cut into individual coils on a band saw.

An electric motor operating through a friction clutch drives the arbor or spindle, and this in turn drives the traversing mechanism, usually a leadscrew, through a gear system. The gears are selected according to the size of the wire to be wound. Adjustable stops control reversal of the leadscrew as dictated by the length of the coil. Recent development of manual machines has concentrated on quick-change mechanisms so that a female operator can quickly change the setup of the machine to a new specification. This feature makes the manual machine especially adaptable for producing coils of few turns and in small-lot quantities.

Commercial coil-winding concerns producing coils for several users, usually in small quantities, are mostly equipped with manual machines because of their extreme flexibility. Generally, however, they have a few automatic machines for high-production stock items.

### **Automatic Interleaf Machine**

Equipment manufacturers who wind their own coils are predominantly equipped with automatic machines, as their runs are long. The automatic machine can be run at higher speeds, up to 2,500 rpm, as the paper is inserted at full speed, whereas the operator must slow down while inserting manually. Furthermore, since the entire wind-

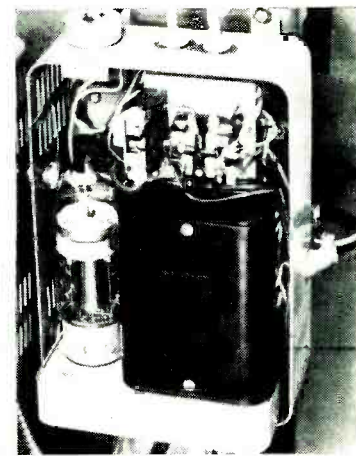
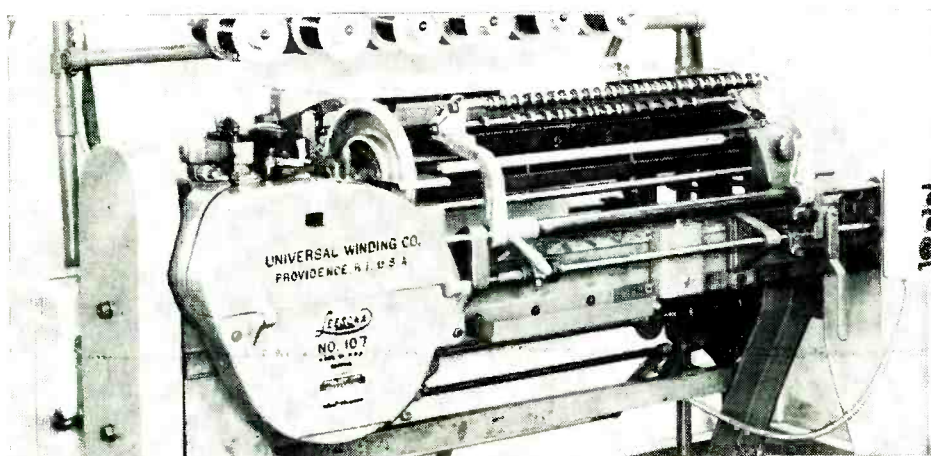

Automatic machine for stick-winding interleaf coils. Electronic motor control box at left provides smooth acceleration from full stop to top running speed, eliminating wire breakage during starting. Paper is fed automatically to coils at high speed, with length of paper being increased as coil diameter increases

Electronic motor control unit for automatic winder. Control box with speed control knob and start-stop buttons is at other end of machine

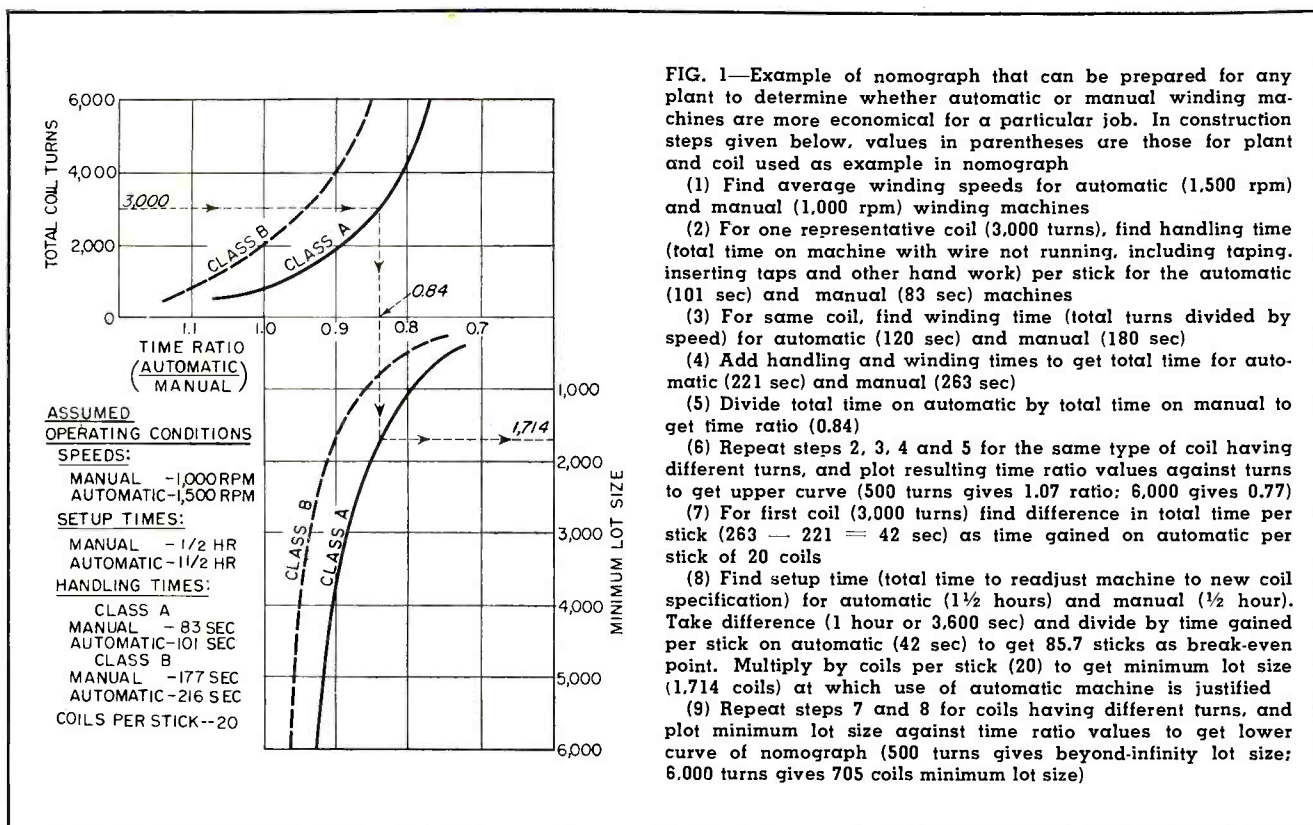

FIG. 1—Example of nomograph that can be prepared for any plant to determine whether automatic or manual winding machines are more economical for a particular job. In construction steps given below, values in parentheses are those for plant and coil used as example in nomograph

- (1) Find average winding speeds for automatic (1,500 rpm) and manual (1,000 rpm) winding machines
- (2) For one representative coil (3,000 turns), find handling time (total time on machine with wire not running, including taping, inserting taps and other hand work) per stick for the automatic (101 sec) and manual (83 sec) machines
- (3) For same coil, find winding time (total turns divided by speed) for automatic (120 sec) and manual (180 sec)
- (4) Add handling and winding times to get total time for automatic (221 sec) and manual (263 sec)
- (5) Divide total time on automatic by total time on manual to get time ratio (0.84)
- (6) Repeat steps 2, 3, 4 and 5 for the same type of coil having different turns, and plot resulting time ratio values against turns to get upper curve (500 turns gives 1.07 ratio; 6,000 gives 0.77)
- (7) For first coil (3,000 turns) find difference in total time per stick (263 - 221 = 42 sec) as time gained on automatic per stick of 20 coils
- (8) Find setup time (total time to readjust machine to new coil specification) for automatic (1 1/2 hours) and manual (1/2 hour). Take difference (1 hour or 3,600 sec) and divide by time gained per stick on automatic (42 sec) to get 85.7 sticks as break-even point. Multiply by coils per stick (20) to get minimum lot size (1,714 coils) at which use of automatic machine is justified
- (9) Repeat steps 7 and 8 for coils having different turns, and plot minimum lot size against time ratio values to get lower curve of nomograph (500 turns gives beyond-infinity lot size; 6,000 turns gives 705 coils minimum lot size)

ing operation is automatic, the operator can perform some finishing operation during winding.

The automatic machine is more expensive and inherently more complex than the manual. Setup time, too, is longer on automatics when changing over from one coil specification to another.

### Choice of Machine

A production engineer fortunate enough to have both manual and automatic winding equipment at his disposal must always analyze each coil specification closely and decide where production would be less costly—on the hand-fed machines or on the automatics. A nomograph of the type shown in Fig. 1 can be worked up for any specific plant to aid in determining whether or not it would be economical to place a coil on an automatic machine. Handling time on the machine when the wire is not running is the variable that depends on the individual plant and the abilities of its mechanics.

The curves shown are for two different ratios of handling times, designated for convenience as class A and class B. Usually a plant will make two or even more distinct

types of coils having different handling times, and here one set of curves is needed for each type on the nomograph. If desired, the curves can be designated more specifically by type names such as *Output, Type 1* or *Reactor, Type 5*, as being more descriptive of the types of work being run by the particular concern.

Once the nomograph has been drawn, its use is simple. Merely trace across from the desired value of coil turns to the appropriate upper curve, trace down from there to the corresponding lower curve, then trace across to the right-hand scale and read the minimum economical lot size for an automatic machine.

### Winding Bobbin Coils

Machines for winding bobbin coils are the simplest of all in construction. Since the flanges of the bobbin support the coil, a precise lay of wire is not required and a gainer mechanism is unnecessary. A wide range of traverse speeds is required, but fine regulation is not. Generally, winders for bobbin coils are of the single-spindle variety with but one coil being wound at a time.

Sometimes two or more single-spindle units are ganged together on a machine to operate with one common traverse mechanism. The three-spindle arrangement lends itself to extremely high operator and machine efficiency, for winding speed can be so adjusted that winding time equals twice the handling time. Two spindles of the machine are always running while the operator tends the third. Just as she finishes at one spindle the next goes down and is ready to be tended. With this system, one coil is obtained for every handling time. The primary rule to follow when placing a coil on this machine is to minimize the amount of handling to be done at the machine. These machines are fitted with special motors and tensions to enable high winding speeds (5,000 rpm), and every effort should be made to take full advantage of this feature. These machines can be purchased with spindles in any multiple up to six, depending on the type of coil to be run.

This discussion has been limited to general over-all considerations pertinent in any plant, in an effort to clarify somewhat the problems facing the coil production engineer.



# Locked-in Oscillator

Electronic selectivity gained with locked-in oscillator provides ability to reject an unwanted signal much greater than can be obtained with tuned circuits alone. Circuits can be used with intercarrier system or 21.25-mc i-f amplifier

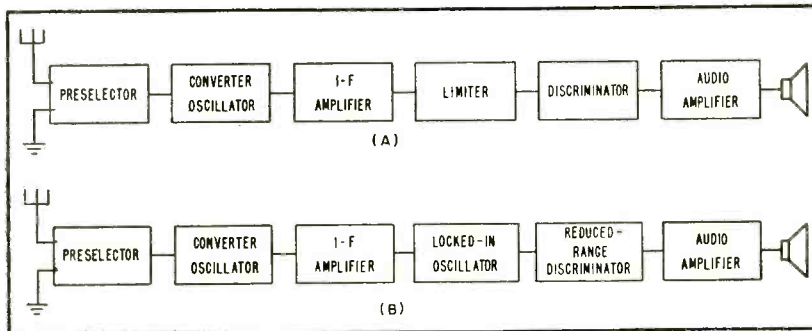

FIG. 1—Stages of receiver employing a locked-in oscillator (B) compared to a conventional receiver (A)

By **MURLAN S. CORRINGTON**

*Home Instrument Department  
RCA Victor Division  
Radio Corporation of America  
Camden, New Jersey*

**D**EVELOPMENT WORK on frequency-modulation receivers has shown that in order to obtain certain desirable performance characteristics it is necessary to convert frequency-modulated broadcast signals, modulated in accordance with present frequency-modulation standards, to signals having reduced swing before they are sent through the discriminator of a receiver and converted to audio-frequency signals. If the first intermediate frequency of a standard f-m receiver is  $10,700 \pm 75$  kc, division by five gives  $2,140 \pm 15$  kc.

The locked-in oscillator provides a simple method for dividing the instantaneous frequency by five. The incoming signal voltage is applied to the first grid of a pentagrid mixer tube, and the third grid and plate are connected in a regular feed-back oscillator circuit. The first grid serves to inject pulses of current into the plate circuit and causes the oscillator to lock in at

one-fifth the frequency of the incoming signal.

This paper presents some improvements on the Beers locked-in oscillator circuit, and some circuits for use in f-m and television receivers, together with a report of field tests.

Figure 1A shows the stages of the limiter-discriminator type of f-m receiver, and Fig. 1B shows how the locked-in oscillator circuits replace the limiter and discriminator. The requirements of the preselector, converter-oscillator, i-f amplifier, and audio amplifier are essentially the same for both circuits.

There is one operating difference when receiving weak signals. The limiter-discriminator receiver can receive a signal so weak that it will not operate the limiter and yet give a usable output if there are no large variations in the amplitude of the incoming wave. These variations can be caused by multipath transmission, by common or adja-

cent-channel interference or by excessive i-f selectivity.

The locked-in oscillator is either locked in or it isn't; there is no intermediate condition. If the incoming signal is too weak to lock in the oscillator for the full deviation, the oscillator may break out at the ends of the swing and cause distortion. The receiver with the locked-in oscillator must have sufficient sensitivity ahead of the locked-in oscillator to assure that the input to the oscillator is enough to lock-in the oscillator for all signals to be received. The oscillator should preferably be used with high-sensitivity receivers since the distortion of a weak signal may be worse than that obtained with a limiter-discriminator or a ratio-detector receiver, when receiving weak stations with low-sensitivity receivers.

## Mechanical Analogy

Figure 2 shows a simple mechanical analogy for the locked-in oscillator. The No. 1 and No. 3 grids of a pentagrid tube are represented by valves that open and close, corresponding to the swings of the grid voltages. The No. 1 valve has a variable opening, corresponding to the variation of the input voltage, and the No. 3 valve is tripped once by the flywheel in each cycle. This is similar to the way the escapement of a watch gives impulses to the balance wheel and keeps it running.

It is necessary for both valves to be open simultaneously for a drop of water (pulse of plate current) to pass. The frequency of the drops is determined by the rate at which the No. 1 valve opens and closes; and the size is determined by how wide the valves open and how long they are open.

The curves in Fig. 2 show the

# for TV Sound

drop size and frequency for each grid separately and for the two together. When the drops fall on the spoon attached to the oscillating flywheel, they will lock in the flywheel with the falling drops and maintain oscillation as long as the frequency of the drops is near the resonant frequency of the flywheel, or an integral multiple of this frequency.

If the rate of the flow of drops is increased, there will be a phase shift between the two valves, so the resultant drops will not be the same size as before. There may be a big one followed by a little one. If the big drop hits the spoon when it is starting its downward motion, the drop will be in the spoon for a fairly long time and the weight can therefore do considerable work on the wheel and thus will speed up the system, keeping it locked in. Likewise if the big drop hits near the bottom of the swing of the spoon, it can do only a small amount of work and the system will slow down. It is thus evident that the drops can lock in the flywheel over a range of frequencies if the relative phase of the two valves is adjusted properly.

## Locking-in Action

The theory of the locking-in process can be explained in the following manner. In the circuit of Fig 3 the oscillator is connected with feedback from the plate tank circuit to the No. 3 grid. This oscillator grid is operated with self bias through grid resistor  $R_3$ . Each time the grid voltage swings positive it draws grid current. For an intermediate frequency of 4,500 kc, the grid operates at one-fifth of this frequency or 900 kc.

The amplitude of the oscillation is determined by the curvature of the  $E_g-I_p$  characteristic and is usually so great that the grid voltage swings well into the curved parts of the tube characteristic during the cycle. This means that pulses of plate current are produced

having component frequencies  $2\omega$ ,  $3\omega$ ,  $4\omega$ , . . . where  $\omega$  is the natural frequency of the tuned plate circuit  $L_2C_4$ . These harmonics are applied to the No. 3 grid through the mutual coupling. Additional harmonics are produced by the grid current pulses.

When the incoming signal at 4,500 kc is applied to the tube, the tube operates as a converter and combination frequencies will be produced equal to  $\pm 5 r\omega \pm s\omega$  when  $r$  and  $s = 0, 1, 2, 3, \dots$ . Since the plate circuit is tuned to 900 kc, the only frequencies which will be amplified are those of frequency  $\omega$ ; the others are bypassed effectively.

If  $r = 1$ , then  $s = 4$  or  $6$  will give frequency  $\omega$ . Then the fourth and sixth harmonics of the oscillator beat with the incoming signal to produce the frequency  $\omega$  in the tank circuit.

If the incoming signal is not exactly five times that of the tank circuit, this combination beat frequency current will not be in phase with the fundamental tank circuit current but will be slightly out of phase. The reactive component of this current will cause the oscillator to work like a reactance tube, thus changing the frequency of the tank circuit just enough to lock it in. This is equivalent to the opera-

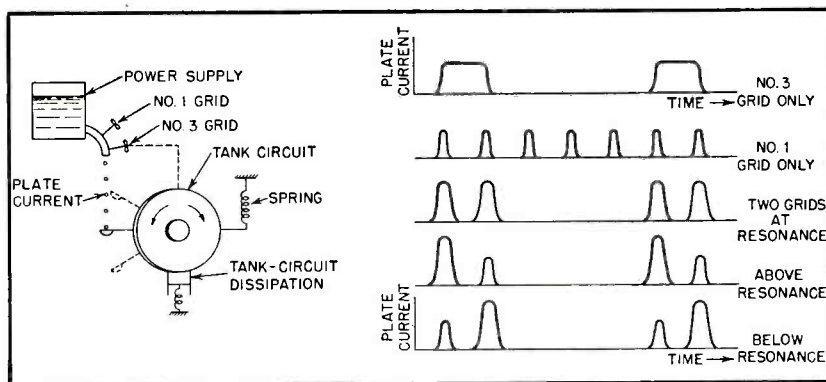

FIG. 2—Mechanical analogy for locked-in oscillator operation

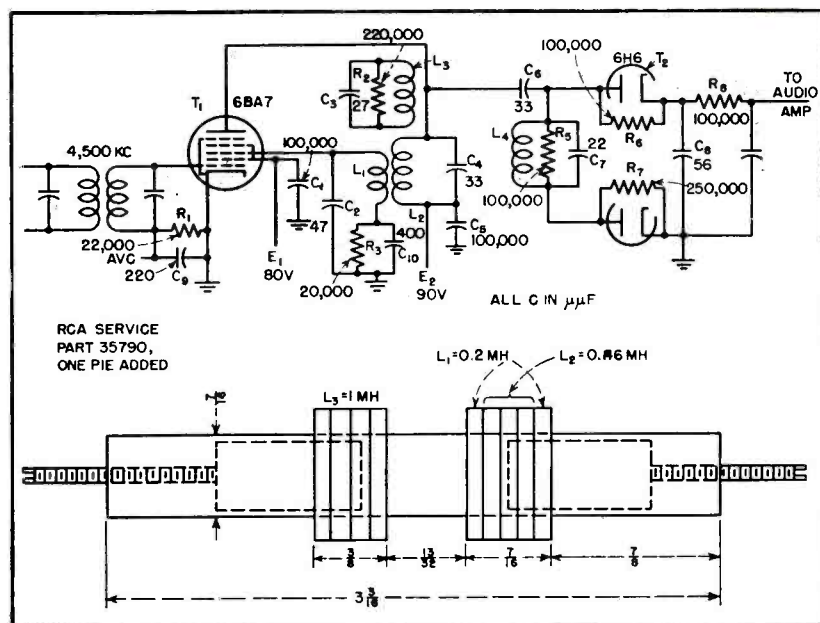

FIG. 3—Circuit and coil construction of oscillator for intercarrier sound



tion illustrated by Figure 2.

The maximum amount of reactive current is produced when all of this beat-frequency current is 90 degrees out of phase with respect to the fundamental tank circuit current. This determines the ends of the lock-in range. If the frequency of the incoming signal is outside this range, the oscillator cannot lock in, and the signal cannot be received. This accounts for the "electronic selectivity" of such a circuit; the over-all selectivity of the circuit will be considerably better than can be obtained by the tuned circuits alone.

### Extending Lock-in Range

Since the amount of fourth or sixth harmonic on the oscillator No. 3 grid determines the magnitude of the reactive current produced, the lock-in range can be extended by placing a parallel tuned circuit in series with the No. 3 grid to enhance the required harmonic. As shown by Fig. 4, this circuit is tuned to the fourth or sixth harmonic of the oscillator tank circuit frequency. This harmonic beats with the incoming signal (5th harmonic) to produce the required fundamental reactive current.

Still greater range can be obtained by detuning the tank circuit to one side and the No. 3 grid parallel circuit of Fig. 4 to the other side of the center frequency.

Another simple way to extend the range is shown by Fig. 3. The

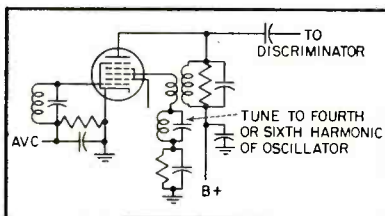

FIG. 4—Tuned circuit in series with No. 3 grid is adjusted to fourth or sixth harmonic of oscillator

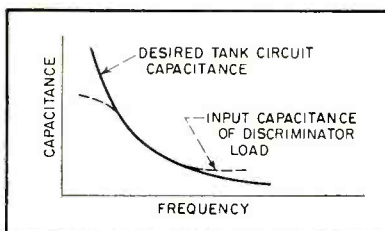

FIG. 5—Frequency change with variation of input capacitance

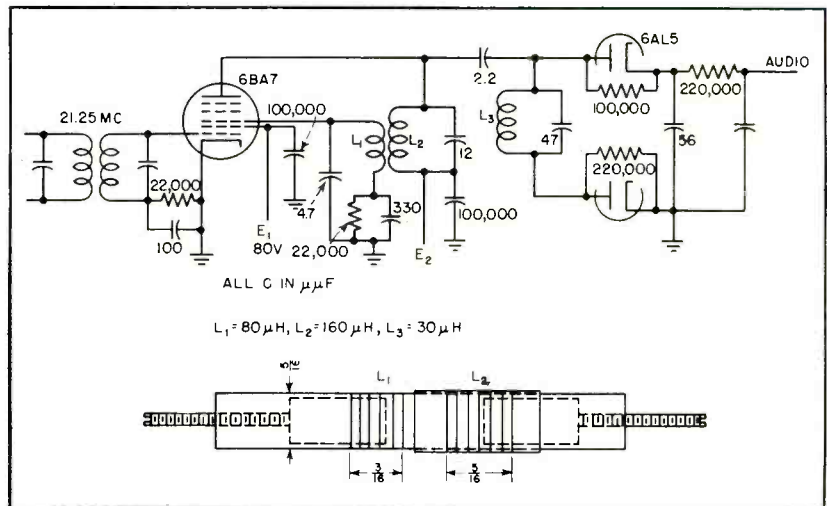

FIG. 6—Locked-in oscillator for 21.25-mc sound channel. Coils  $L_1$  and  $L_2$  are slightly overcoupled and mounted in a separate shield can from  $L_3$

coupled circuit  $L_3C_3$  is used to broaden out the selectivity curve of  $L_2C_2$ , and give increased lock-in range. Continuous variation of selectivity can be obtained by adjusting  $R_2$  to change the Q of the circuit or by adjusting the mutual coupling between  $L_3C_3$  and  $L_2C_2$ . In case of bad interference the selectivity can then be adjusted until the lock-in range is barely enough to accommodate the frequency swings of the incoming signal, thus giving the highest signal-to-noise ratio.

If the circuits of the load on the oscillator are properly designed, it is possible to increase the lock-in range. The discriminator of Fig. 3 was designed so that the input capacitance of the circuit consisting of  $C_6$  and the discriminator fall off at just the proper rate to keep the oscillator in tune over most of the operating range. This variation is shown by Fig. 5. Care must be used to get this load just right. Other discriminators, such as the Seeley discriminator, do not have the proper input characteristic. If the decrease in capacitance of the load is too rapid, so the two curves of Fig. 5 cross over at three points, the circuit becomes unstable between the two outer points. This will be evident during alignment.

As the oscillator frequency is adjusted, it changes smoothly up to a certain frequency and then suddenly jumps to another frequency. There is a range within which it is not possible to tune the oscillator

because of the instability. Usually this can be corrected by using a smaller coupling capacitor between the oscillator and discriminator, by adding a small series resistor, or by redesigning the discriminator.

### Design of Discriminator

A very simple discriminator is used in this system. In Fig. 3, capacitor  $C_6$  couples the discriminator to the oscillator. The tuned circuit  $L_4C_7$ , together with the interelectrode capacitance of the diode (in parallel with  $R_7$ ), forms the discriminator. At series resonance between  $L_4$  and the interelectrode capacitance of the lower diode, a maximum voltage appears across this diode. At parallel resonance of  $L_4$  and  $C_7$ , a maximum of voltage appears across the upper diode. The result is a balanced discriminator, with the bandwidth determined by the difference between the series and parallel resonant frequencies.

Resistor  $R_6$  controls the parallel Q of the circuit and  $R_7$  controls the effective series Q. For best linearity these two values of Q should be approximately equal. But  $R_7$  will therefore not necessarily equal  $R_6$ , since one shunts the series capacitor and the other is across the entire circuit.

### Adjustment

For the circuit of Fig. 3, the auxiliary coupled circuit  $L_3C_3$  is tuned to the same frequency as the oscillator tank circuit (900 kc) and is slightly overcoupled with respect

to the circuit,  $L_2C_4$ . To adjust the circuit, tune the oscillator tank circuit until the oscillator locks in with an incoming frequency-modulated signal from a signal generator, which feeds into the i-f channel at 4,500 kc.

Remove the modulation, leaving the carrier at 4,500 kc. Adjust the discriminator to zero balance by connecting a d-c voltmeter from either end of  $R_8$  to ground and adjusting  $L_4$  until there is no voltage from  $R_8$  to ground. Next adjust  $L_2$  until the lock-in range is approximately symmetrical about the center frequency (900 kc). Then adjust  $L_3$  to extend the lock-in range to the desired amount. A slight readjustment of  $L_2$  may be necessary for best results.

For a practical application of the circuit, the constants shown can be used. The oscillator transformer can be made from a standard i-f transformer (RCA service part 35790) by adding one pie, increasing the coupling by moving the coils closer together and reconnecting the pies. The oscillator tank coil  $L_2$  is composed of three pies in series aiding and  $L_1$  is formed of two pies, one on each side of  $L_2$ , connected in series aiding. This gives fairly tight coupling without increasing the inductance of  $L_1$  beyond the allowable limits. The cores are inserted into the coils as shown.

If the effective coupling between  $L_2$  and  $L_3$  is gradually increased from some low value by moving  $L_3$  closer to  $L_2$  the lock-in range will increase uniformly until the oscillator begins to give a distorted output in the middle of the lock-in range. Further increase in coupling will cause the oscillator to break out in the middle of the range but not at the ends. This gives a simple means for adjusting the lock-in range.

The same result can be obtained by shunting  $L_3$  with a variable resistance, since a decrease in the  $Q$  of  $L_3$  is equivalent to a decrease in coupling. Loading a transformer with resistors decreases the effective coupling.

In a standard television receiver with a sound i-f of 21.25 megacycles, the locked-in oscillator can be simplified to that shown by Fig. 6. Because of the limited deviation

used, no circuits are needed to extend the lock-in range. This circuit requires separate shield cans for the oscillator and the discriminator. If it is preferred to use a single coil assembly and shield can, the circuit shown in Fig. 7 is satisfactory. All three coils are on the same form and can be adjusted with the two iron cores.

### Performance During Interference

To test the locked-in oscillator circuit of Fig. 6 under operating conditions, it was installed in an RCA 8T241 television receiver in place of the amplifier and discriminator in the 21.25-mc sound channel. The lock-in range was approximately  $\pm 25$  kc at 0.3-volt input to the No. 1 grid of the 6BA7,  $\pm 100$  kc at 1-volt input and  $\pm 200$  kc at 5 volts input.

The complete locked-in oscillator receiver was tested by connecting two signal generators to the input antenna terminals, one to represent the desired signal and the other to represent the common-channel interfering signal. The desired signal was at 179.75 mc (channel 7) modulated with a deviation of  $\pm 22.5$  kc and an audio repetition rate of 1,000 cycles per second. The second signal had the same center frequency and deviation but an audio rate of 400 cycles per second.

The curves of Fig. 8 show how the receiver completely suppresses

the undesired signal until the two are almost equal. In the first pair of curves the desired signal was 100 microvolts, and the undesired one was gradually increased until it equaled and then captured the desired signal. The amount of 400 and 1,000-cycle audio in the output was measured with a wave analyzer. For the input of 100 microvolts the locked-in oscillator barely had enough signal to work, but as the level increased the capture effect is very pronounced.

The curves show that if the undesired signal is 80 percent of the desired signal, for an input of 10,000 microvolts, the 400-cycle note is down 32 db, while with the standard receiver it is only down 8 db. The final value of the 400-cycle amplitude is slightly higher than that for 1,000 cycles because of the 1-db difference in the 75-microsecond deemphasis curve.

The practical meaning of this test is that if the receiver is capable of suppressing any undesired carrier wave unless it is at least 80 or 90 percent as strong as the desired carrier wave, compared to about 30 percent for a conventional receiver, the area in which such interference can occur is very much reduced. Many areas where intolerable distortion occurs in conventional receivers are completely free from interference with the locked-in oscillator. Since even a

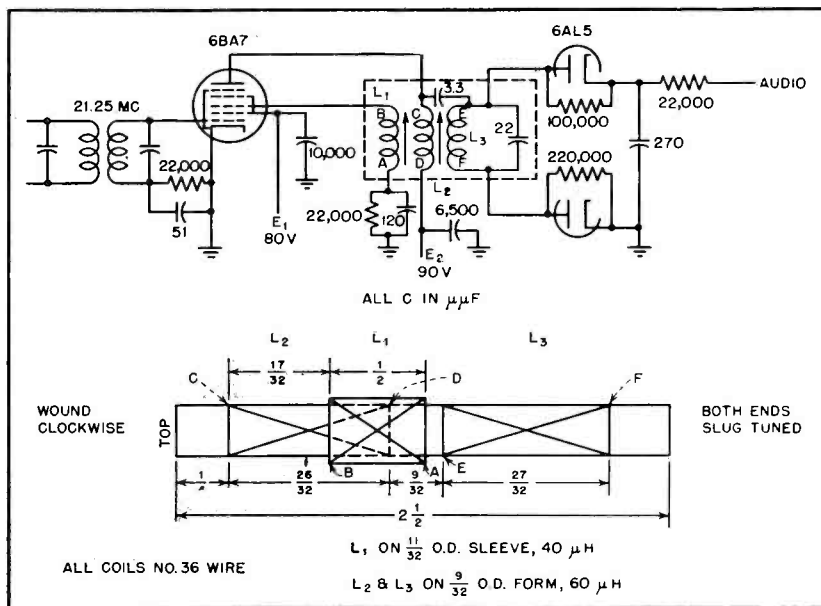

FIG. 7—Alternative circuit for 21.25 mc, with all three coils mounted on one form and installed in one shield can



slight reduction in the undesired signal will suppress it, it is often easy to use the antenna directivity for this purpose.

### Comparison With Ideal Receiver

Since the solution of the problem of common-channel interference, where each carrier wave has sinusoidal frequency modulation, is known, it is interesting to see how close the performance of the locked-in oscillator can approach the mathematical limit of performance. The audio output from an ideal f-m receiver with a perfect limiter and a very wide but linear discriminator is given by the equation

$$\begin{aligned} \text{Audio output} &= D_1 \cos 2\pi\mu_1 t + \\ &\sum_{r=-\infty}^{\infty} \sum_{s=-\infty}^{\infty} (r\mu_1 - s\mu_2) \\ &C\left(r, \frac{D_1}{\mu_1}; s, \frac{D_2}{\mu_2}; x, 0\right) \cos(r\alpha - s\beta) \quad (1) \end{aligned}$$

where  $x$  = ratio of carrier wave amplitudes  
 $D_1$  = deviation of first carrier wave  
 $\mu_1$  = audio repetition rate of first carrier wave  
 $D_2$  = deviation of second carrier wave  
 $\mu_2$  = audio repetition rate of second carrier wave  
 $\alpha = 2\pi\mu_1 t$ ,  $\beta = 2\pi\mu_2 t$ ,  $t$  = time,

and the generalized  $C$ -function is defined as follows:

$$C(k, l; m, n; x, \theta) = \sum_{s=1}^{\infty} \frac{(-x)^s}{s} J_k(sl) J_m(sn) \cos s\theta \quad (2)$$

To use available tables of Bessel functions, assume the following values of frequency,

$D_1 = 10,000$  cps       $D_1/\mu_1 = 25$   
 $D_2 = 10,000$  cps       $D_2/\mu_2 = 10$   
 $\mu_1 = 400$  cps  
 $\mu_2 = 1,000$  cps

When these values are substituted into Eq. 1, and all combination frequencies equal to  $\pm 400$  cps and  $\pm 1,000$  cps are sorted out and combined, the results are

400-cycle distortion = 800

$$\sum_{n=-\infty}^{\infty} C(10n + 1, 25; 4n, 10; x, 0) \quad (3)$$

and the 1,000-cycle distortion = 2,000

$$\sum_{n=-\infty}^{\infty} C(10n, 25; 4n - 1, 10; x, 0) \quad (4)$$

The  $C$ -functions were computed, in accord with Eq. 2, and the series summed in accord with Eq. 3 and 4.

Figure 9 shows the capture effect to be expected in an ideal f-m receiver under the assumed conditions. As the level of the 1,000-cycle interfering carrier wave is raised toward equality with the 400-cycle wave, the amount of the 1,000-cycle component in the audio output rises uniformly from a value approximately 64 db down when the ratio of carrier wave amplitudes is 0.1 to a point approximately 37 db down when the amplitudes are equal. At this point the 1,000-cycle carrier wave suddenly captures the other wave, causing full output at 1,000 cycles, and the 400-cycle component drops approximately 38 db. Beyond this point the amount of 400-cycle interference decreases smoothly.

The curves of Fig. 8 and 9 are not directly comparable because the deviation is different. However, for the higher signal levels the locked-in oscillator comes very close to the mathematical limit of performance. In a laboratory setup, working the signal generators directly into the i-f amplifier, it is possible to come so close to the ideal that a change in level as small as 5 percent will cause one signal to capture the other and almost completely suppress the accompanying distortion.

Extensive field tests have been made to compare such a locked-in oscillator with other conventional receivers such as the limiter-discriminator circuit, the intercarrier-sound system and the ratio detector. In every case the locked-in oscillator was at least as good as any of the others and whenever the interference was severe it usually was better. At times it gives a signal almost free from noise when the other systems are so distorted they are unintelligible.

### Conclusions

It is often desirable to convert frequency-modulated signals having a frequency deviation up to  $\pm 75$  kc to signals of reduced carrier frequency and of reduced frequency deviation before they are sent through the discriminator of a receiver and converted to audio-frequency signals. Division of the instantaneous frequency by five reduces normal maximum frequency swings from  $\pm 75$  kc to  $\pm 15$  kc. Smaller deviations are reduced in proportion. The locked-in oscillator provides a simple and practical means for performing this division.

Since the tube operates as an oscillator with fairly large voltages on the No. 3 grid, the grid voltage swings well into the curved parts of the tube characteristic and gener-

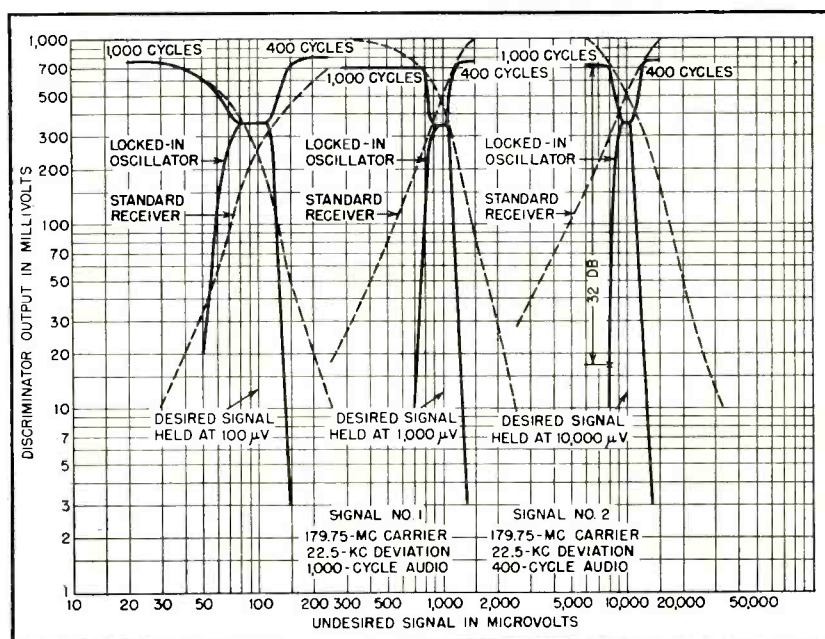

FIG. 8—Comparison of interference rejection of locked-in oscillator and RCA 8T241 receiver

ates harmonics in the No. 3 grid circuit. When the division ratio is five to one, the fourth and sixth harmonics of the oscillator beat with the incoming signal to produce a current having a difference frequency, which is just equal to the output frequency. When the incoming signal frequency is exactly five times the normal oscillator frequency, this injected current, which has the same frequency as the oscillator, is in phase with the normal plate current.

When the incoming signal frequency is increased, the injected current lags the normal plate current and cancels part of the leading current through the tank-circuit capacitor, thus effectively lowering the capacitance and raising the frequency of the circuit. This enables the oscillator to remain locked-in. The maximum amount the incoming signal frequency can be increased before the oscillator breaks out occurs when the incoming signal and likewise the injected current lag the normal plate current by 90 degrees, since this results in maximum quadrature current.

In a similar way, when the incoming signal frequency is less than five times the normal plate circuit frequency, the injected current leads the normal plate current and is thus equivalent to a larger capacitor in the tank circuit. This lowers the oscillator frequency and enables it to remain locked in. The lower end of the lock-in range is reached when the injected current leads the normal plate current by 90 degrees. The circuit thus behaves like a reactance tube since it generates a quadrature component in the plate circuit.

### Self Bias

When the tube operates with self bias on the grid, the output voltage from the oscillator is substantially constant for large variations in the signal voltage. It thus eliminates the need for a limiter in f-m receivers since the incoming signal is used only to control the frequency of the locked-in oscillator and not to produce a voltage output.

It is relatively easy to design the external load on the tank circuit so the equivalent input capacitance decreases with increasing fre-

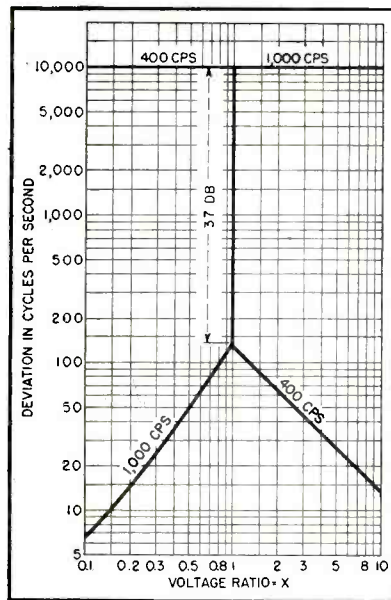

FIG. 9—Capture effect in a theoretically ideal f-m receiver

quency at just the proper rate to keep the oscillator in tune over a wide portion of the lock-in range. This results in improved performance and an extended lock-in range. The L-C ratio of the tank circuit can be adjusted to just match the frequency discriminator for best operation.

When receiving a standard f-m signal, it is important that the oscillator have a lock-in range somewhat greater than the total swing of the transmitter. If it does not, slight mistuning or oscillator drift, or overmodulation at the transmitter, will cause the oscillator to break out at the ends of the frequency swing and this results in disagreeable distortion.

It is possible to obtain an adequate lock-in range in several ways. Proper match of the discriminator to the oscillator is important, and this can be obtained by adjustment of the L-C ratio of the tank circuit, by varying the series coupling capacitor, by adjustment of the Q of the circuit in the discriminator, or by the addition of circuits which selectively control the amplitudes of the harmonics in the oscillator circuit. The last method enables very wide lock-in ranges to be obtained. With conventional tubes, the circuits should be designed to supply at least 0.5 to 1.0 volt on the input grid.

Extensive laboratory and field tests show that the performance of

the locked-in oscillator comes very close to the mathematical limit for an ideal receiver. A standard television receiver with such a sound channel can suppress an interfering carrier wave less than eighty percent of the desired wave. This means that in fringe areas where there is considerable interference the locked-in oscillator is capable of reducing the area of interference considerably. If antenna directivity is also used, it will be possible to clear up most cases of interference.

A receiver with the locked-in oscillator must have sufficient sensitivity ahead of the locked-in oscillator to assure that the input to the oscillator is enough to lock-in the oscillator for all signals to be received. This means that the circuit should preferably be used with high-sensitivity receivers since the distortion of a weak signal may be worse than that obtained with a limiter-discriminator or a ratio-detector receiver, when receiving weak stations with low-sensitivity receivers.

### BIBLIOGRAPHY

- G. L. Beers, A Frequency-Dividing Locked-in Oscillator Frequency-modulation Receiver, *Proc. IRE*, 32, No. 12, p 730, Dec. 1944. Also U. S. Patent 2,356,201, filed Feb. 12, 1942, issued Aug. 22, 1944.
- Lord Rayleigh, "The Theory of Sound," Macmillan and Co., Ltd., London, 1, 2nd ed., p 66, 1937.
- Hans Seiberth, Mitnahmerscheinungen in der Akustik, *Hochfreq. und Elek.*, 45, No. 5, p 148, May 1935.
- E. V. Appleton, The Automatic Synchronization of Triode Oscillators, *Proc. Camb. Phil. Soc.*, 21, p 231, 1922.
- Donald L. Herr, Oscillations in Certain Nonlinear Driven Systems, *Proc. IRE*, 27, p 396, June 1939.
- W. Wenke, Die Instabilität linearer und nichtlinearer Schwingungen (Mitnahmeschwingungen), *Hochfreq. und Elek.*, 55, No. 3, p 94, March 1940. Also p 109, Apr. 1940.
- Samuel Sabaroff, Theory of Frequency Controlled Oscillators, *Jour. App. Phys.*, 11, No. 8, 538, Aug. 1940. See also S. Sabaroff, Frequency Controlled Oscillators, *Communications*, 19, No. 2, p 7, 1939.
- H. Samulon, Über die Synchronisierung von Röhrengeneratoren, *Helvetica Physica Acta*, 14, No. 4, p 281, 1941.
- C. W. Carnahan and Henry P. Kalmus, Synchronized Oscillators as F-M Receiver Limiters, *ELECTRONICS*, 17, p 108, Aug. 1944.
- Robert Adler, A Study of Locking Phenomena in Oscillators, *Proc. IRE*, 34, p. 351, June 1946.
- D. G. Tucker, Nonlinear Regenerative Circuits, *Wireless Eng.*, 24, No. 235, p 178, June 1947.
- U. S. Patent 2,488,584, Murlan S. Corrington, filed Dec. 8, 1943, issued Nov. 22, 1949.
- U. S. Patent 2,488,585, Murlan S. Corrington, filed May 29, 1945, issued Nov. 22, 1949.
- U. S. Patent 2,440,653, Murlan S. Corrington, filed Nov. 14, 1944, issued April 27, 1948.
- Murlan S. Corrington, Frequency Modulation Distortion Caused by Common and Adjacent-channel Interference, *ROA Review*, 7, No. 4, p 522, Dec. 1946.



# Direct-Coupled Amplifier

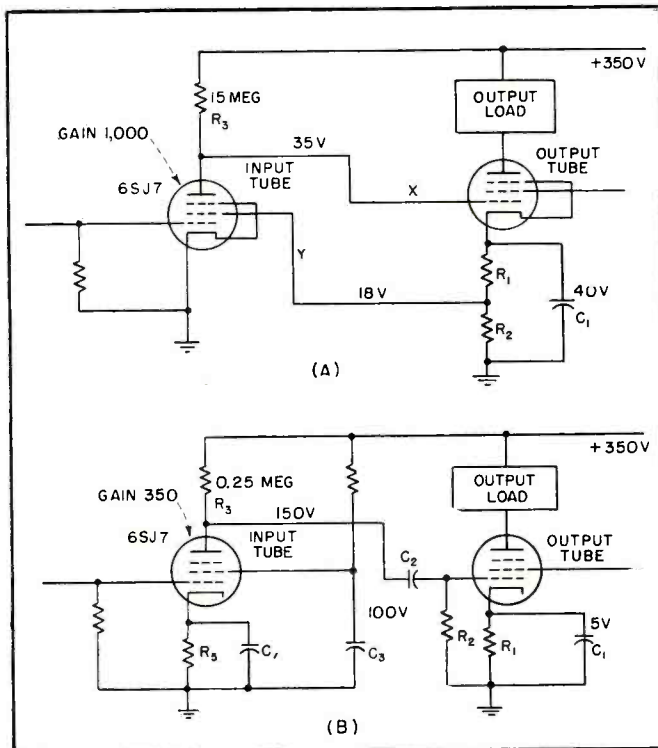

FIG. 1—Starved direct-coupled amplifier (A) and conventional R-C amplifier using two more resistors and three capacitors

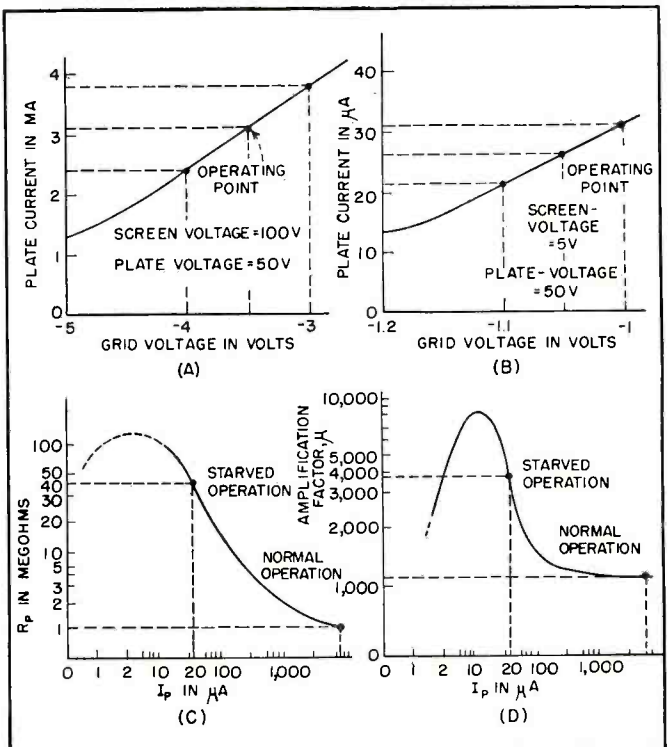

FIG. 2—Decrease of  $G_m$ , increase of  $R_p$  and increase of  $\mu$  owing to use of the starvation circuit

**B**Y LOWERING the screen voltage of pentodes below 10 percent of their plate-supply voltage and increasing the resistance of their plate load 10 or more times beyond conventional values, the amplification factor of such "starved" tubes is greatly increased in spite of a decrease of their mutual transconductance. Stage gains as high as 2,500 have been measured in this condition, using regular 6SJ7 tubes. By incorporating the principle of starvation in a new direct-coupled amplifier two basic aims can be achieved: a drastic increase of overall gain permitting omission of amplification stages and reduction of manufacturing costs (for example, a 3-tube radio receiver requiring only 4 resistors and 4 capacitors), or trading surplus gain for minimum distortion and maximum stability.

Such starved direct-coupled amplifiers are in practical use today. They are employed in certain oscilloscope preamplifiers and vacuum-tube millivoltmeters for which circuit diagrams are shown. The cir-

## By WALTER K. VOLKERS

Vice-President, Millivac Instruments Corp.  
New Haven, Conn.

cuit is also suitable for use in future domestic radio receivers. All these amplifiers have exceptionally high stage-gains in their input stage. Gains of 1,000 in a single stage are common when using ordinary plate supply voltage in the order of 350 v, and gains as high as 2,500 have been measured with higher voltages. Conventional radio tubes, such as the 6SJ7, show such high gains when starved.

### Basic Circuit

The basic circuit of a starved direct-coupled two-stage amplifier is shown in Fig. 1A. It has several characteristics that distinguish it from the ordinary R-C coupled amplifier in Fig. 1B.

There are two connections (marked X and Y) between the input and the output tube in Fig. 1A.

The coupling lead X carries the audio signal from the plate of the input tube to the grid of the output tube, and Y, called the self-focusing circuit, connects the screen of the input tube to a tap on the cathode resistor of the output tube. At the same time Y provides sufficiently low screen potential for the input tube, causing this tube to operate in a starved manner. Self-focusing is an essential feature in a d-c amplifier to prevent the average or no-signal plate current of the output tube from drifting towards the tube's upper or lower cutoff points as line or supply voltage change, resistors age or tubes are exchanged. Actually the self-focusing circuit is a high-gain negative d-c feedback circuit. In this particular case it operates as described below.

Let us assume that the output tube's plate current, for some reason, such as a change of contact potential of the input tube, begins to drift toward the upper cutoff. This effect would increase the no-signal or d-c voltage drop across

# STARVATION CIRCUITS

Stage gains up to 2,500 can be obtained in direct-coupled amplifiers by using pentodes with extremely low screen voltage and high plate load resistance. Circuit requires fewer components, making possible an a-m radio receiver having only four resistors

cathode resistors  $R_1$  and  $R_2$  of this tube and would raise the screen potential of the input tube. That tube will therefore draw more direct current from B plus and increase the voltage drop across its plate resistor  $R_3$ . Lowering its plate voltage will also decrease the grid potential of the output tube, owing to the direct coupling. As a result of this negative d-c feedback action the output current will increase less than it would without the self-focusing circuit. In fact, in some meter amplifiers to be described, the self-focusing action of circuit Y has added to it a second self-focusing channel. The effect has been made so vigorous that these amplifiers can be operated over B plus voltage-fluctuation ranges between 120 percent and 35 percent of normal value without the output tube's plate current drifting appreciably from the desired value.

## Starvation

The relationship between grid control voltage and plate current of a 6SJ7 tube having a screen potential of 100 volts is shown in Fig. 2A. Figure 2B shows the corresponding characteristics of the same tube operating with a screen potential of 5 volts, causing the tube to be starved. The transconductance under conditions of Fig. 2B is very much lower than for those in Fig. 2A (approximately 100 micromhos instead of 1,300). The plate resistance, shown in Fig. 2C, is increased as plate current is decreased due to starvation. Under normal operating conditions of around 2 ma it is about 1.5 megohms. In the starved condition with plate current at 20 microamperes it is somewhere near 40 megohms. Figure 2D shows how

amplification factor  $\mu$ , the product of transconductance and plate resistance, grows with increasing starvation from somewhere near 1,200 to over 8,000 (at 10 microamperes) and then rapidly falls off as the tube becomes overstarved.

The two main advantages of the starved direct-coupled amplifier over the R-C-coupled circuit are indicated in Fig. 1. Its gain is 1,000 instead of 350 and there is a drastic reduction in the number of circuit elements used. The R-C-coupled circuit has 6 resistors and 4 capaci-

tors; the starved direct-coupled circuit requires only 4 resistors and 1 capacitor. The saving of parts in the direct-coupled circuit results partly from more favorable physical operating conditions. For instance, in Fig. 1A the input tube's screen, at only 18 volts when plate voltage is 35 volts, does not draw more than about 1 microampere. Since the cathode resistor of the output tube to which the screen of the input tube is attached constitutes a stiff voltage divider, no screen bypass capacitor is needed. The equivalent of  $C_3$  in Fig. 1B is therefore saved. Starved pentodes have a tendency to develop strong negative contact potentials on their control grids. These potentials exceed even those of high- $\mu$  triodes. As a result, the cathode-bias resistor  $R_6$  and its bypass capacitor  $C_4$  can be left out in the direct-coupled starved circuit. Coupling capacitor  $C_2$  between the tubes is unnecessary.

## Voltage Distribution

The voltage distribution in the circuit of Fig. 1A is unusual but typical of the starved direct-coupled amplifier.

The plate voltage of the input tube, sometimes called coupling voltage because it constitutes the grid potential of the output tube, is 35 v, or only 10 percent of the plate-supply voltage. In other than a starved circuit a plate voltage representing such a small percentage of the plate supply voltage would cause both low gain and distortion.

An unstarved tube, represented by Fig. 3B, shows a nearly symmetrical plate-voltage curve. It is straight near its middle between the upper and the lower cutoff

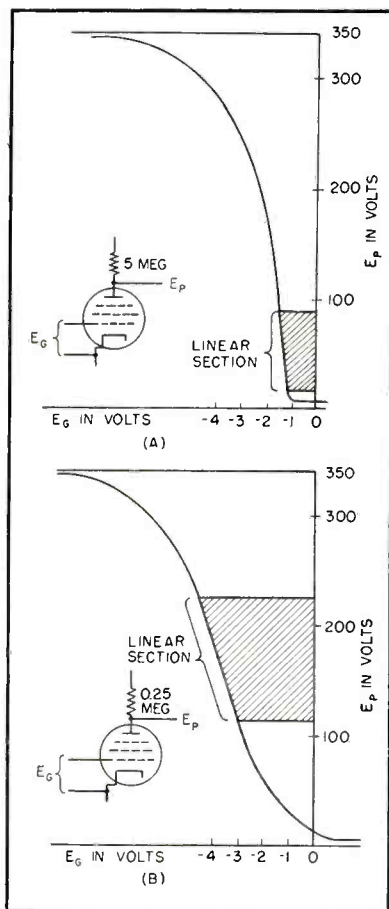

FIG. 3—Plate output voltage characteristic of starved tube (A) and that of unstarved tube (B)





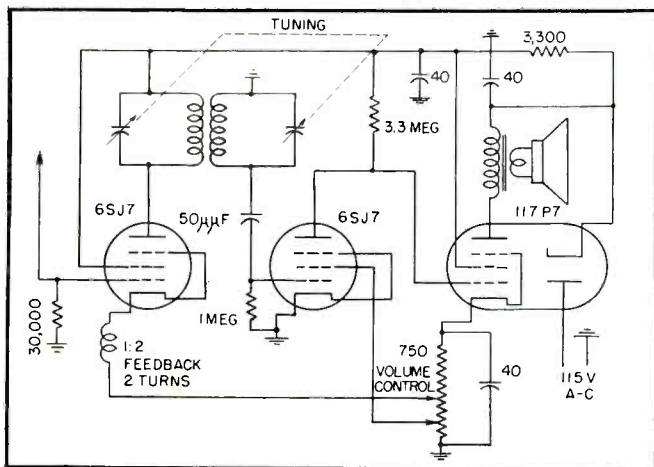

FIG. 6—Circuit of simple a-m broadcast receiver using starvation circuit

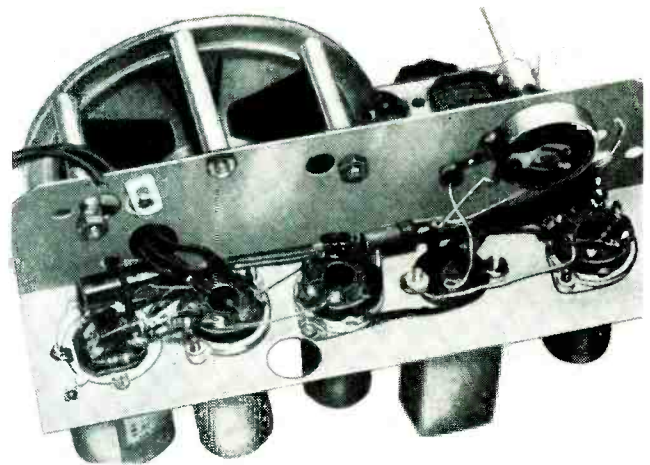

FIG. 7—Underchassis view of receiver, showing how few parts are needed

The heavy negative signal feedback in this amplifier is more than 1,000 to 1, greatly reducing hum pickup and tube noise. For this reason it is possible to build such an amplifier with less than 25 microvolts noise using 6SJ7 a-c heater tubes.

Negative feedback, with all its recognized advantages against distortion and noise, can be a two-edged weapon if applied in an ordinary R-C coupled circuit to an excessive degree. After all, negative feedback, if not completely 180 degrees out of phase with the input signal, contains a regenerative or positive feedback component. With moderate ratios of feedback, such as 3 to 1 or 10 to 1, this component does little harm. With higher ratios of feedback such as 1,000 to 1 or 2,000 to 1 this component can and often does cause oscillation. Owing to the lack of phase rotation, the starved direct-coupled amplifier will tolerate negative feedback ratios well over 5,000 to 1 without oscillating.

For more than a year the Millivac MV-17b vacuum-tube d-c millivoltmeter shown in Fig. 5 was manufactured with an R-C coupled carrier amplifier. This amplifier was then replaced by a starved direct-coupled amplifier, saving 40 percent of its capacitors and reducing the number of tubes from 7 to 4. Power consumption of the instrument decreased to such an extent that all ventilation holes could be omitted. Owing to the high ratio of feedback used in this meter its stability was greatly increased.

Before the change was made, this particular instrument responded to line-voltage fluctuations by about 4 percent for full-scale reading for every 10 percent of line-voltage change. With the starved direct-coupled amplifier and high feedback, the line voltage response is less than 1 percent for 20-percent line voltage change.

Incidentally, the circuit is a good example of mixed direct-coupled and R-C-coupled operation of audio amplifiers. The voltage preamplifier has two direct-coupled stages. The input tube is starved and has a gain of 1,000 or more. The second stage is not starved and has a gain of 200, bringing the total gain of the first two stages to 200,000. The starved amplifier amplifies the carrier signal produced by a d-c modulator having less than 10 microvolts noise at 11 megohms input impedance. The negative feedback, on the most sensitive scale of this voltmeter, is roughly 100 to 1 and on the less sensitive scales, 1,000 to 1. With such high feedback rates, tube noise and hum are negligible.

Finally, a simple 3-tube domestic radio receiver is shown in Fig. 6. Its performance comes surprisingly close to the performance of regular 5-tube a-c/d-c receivers in spite of the fact that it has only four small carbon resistors and, besides its triple electrolytic capacitor, only two small paper capacitors of which one can be eliminated by providing equal intercoil capacitances.

The audio amplifier of this re-

ceiver is starved and direct-coupled. It, therefore, requires only 10 millivolts detector-output signal to drive the loudspeaker. The r-f signal fed into the detector to drive the audio amplifier is only a fraction of that normally required. Consequently, a single high-gain, double-tuned, high-Q r-f stage was chosen. This stage has both tuned circuits on its output side and uses an untuned input. In this manner parasitic oscillation through magnetic feedback between the input and the output circuit, a common weakness of trf receivers, is avoided.

A general objection against untuned r-f inputs of this type is that powerful local stations might cause cross-modulation with weaker ones. In this instance, the danger hardly exists because the output signal of the r-f stage is only approximately 1/10th of the r-f output feeding into the detector of ordinary radio receivers. Therefore, the r-f input at the antenna grid need be only 1/10th of the input required under ordinary conditions. In addition, the absence of magnetic coupling between the input and output circuits of the r-f stage and the inherent high Q of the output circuit make it possible to operate this stage with a gain of 250. The r-f input signal requirements are then so small that local stations simply cannot create signal amplitudes at the control grid large enough to cause cross-coupling. Practically, this effect is accomplished by giving the input tube a grid leak of 30,000 ohms and a short antenna wire.



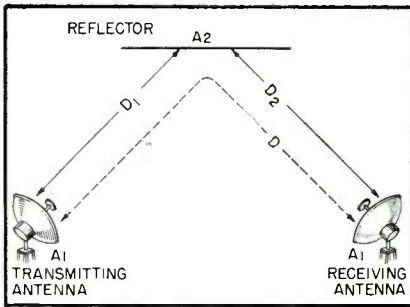
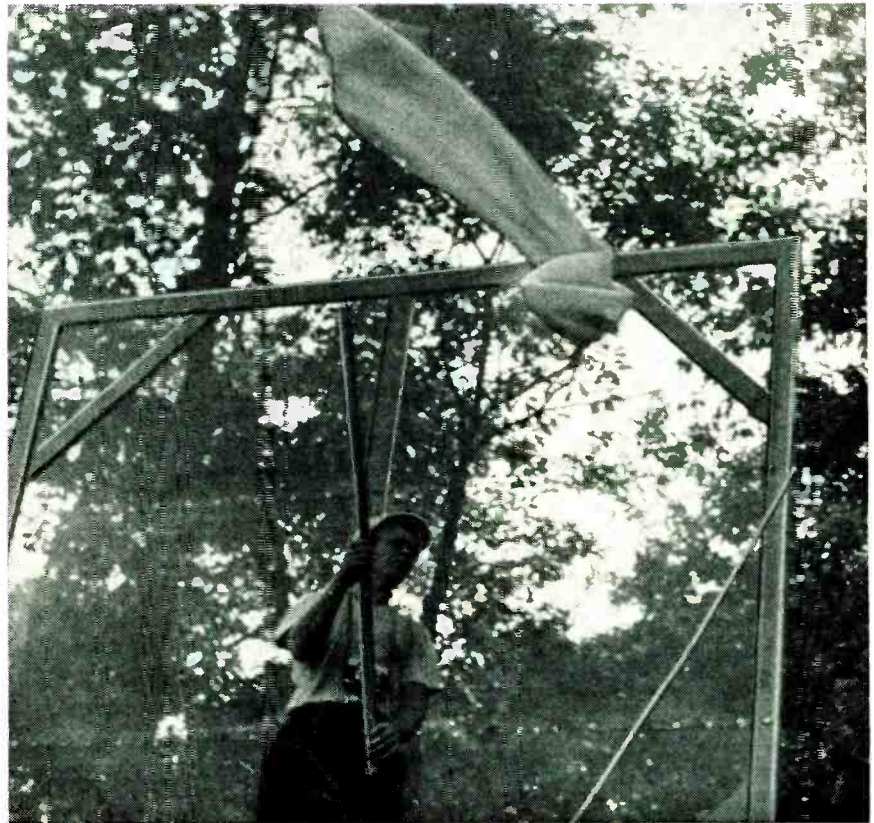

FIG. 1—Details of path using a passive repeater. Areas *A* are measured in sq ft

Table I—Normalized DB Gain vs Position of Passive Repeater

$D_1/D$	DB Gain
0.001	60.0
0.01	40.0
0.02	34.2
0.05	26.5
0.1	20.9
0.2	15.9
0.3	13.6
0.4	12.4
0.5	12.0



Passive reflector in process of being oriented. Reflector consists of  $9 \times 10$ -foot surface of  $\frac{1}{8}$ -inch mesh galvanized screening. Screen openings are small compared to  $\lambda/4$

# Flat Reflector for UHF

Passive repeaters in microwave relay systems provide low-cost means for getting around line-of-sight obstacles. Data presented here are derived from experiments on commercial 960-mc power company installation

**I**N STUDYING conditions peculiar to the design of microwave systems for power company use, it was found that one of the problems encountered at times was that of getting a signal into or out of a deep valley. Quite often the power station, located at the foot of a dam in a deep gorge, must tie into an integrated microwave communication system with other power stations for dispatching or control circuits. For the system to compare favorably with an equivalent wire line circuit as far as economics are concerned,

the number of repeater stations must be held to a minimum.

### Qualitative Study

To determine whether it was feasible to use a reflector as a passive repeater, a qualitative study of the subject was made. There are undoubtedly several methods of examining repeaters—however, for the purposes of this study the line of approach outlined below was used.

Assuming the reflector to have the same effect as one antenna receiving a signal and a second an-

tenna reradiating it, and using a formula from a paper by Friis<sup>1</sup>, the following relationship was set up (see Fig. 1):

$$\frac{P_T}{P_R} = \frac{D_1^2 \lambda^2}{A_1 A_2} \times \frac{D_2^2 \lambda^2}{A_1 A_2} \times \frac{D^4}{D^4}$$

$$= \frac{D^2 \lambda^2}{A_1^2} \times \frac{D^2 \lambda^2}{A_2^2} \times \frac{D_1^2 D_2^2}{D^4}$$

$\uparrow$                        $\uparrow$                        $\uparrow$   
 $X$                        $Y$                        $Z$

where  $P_T/P_R$  is the ratio of transmitted power to received power.

The total loss can be considered as consisting of three factors:



View of West hydro electric station, taken from reflector location atop Hunt's Mountain, shows clear path for reflected 960-megacycle signals transmitted at Stewart's Bridge. Path shown corresponds to ½-mile leg illustrated in plan drawing below

# System

By **THOMAS ROYLSTON**

*Microwave Engineering Department  
Radio Corporation of America  
RCA Victor Division  
Camden, New Jersey*

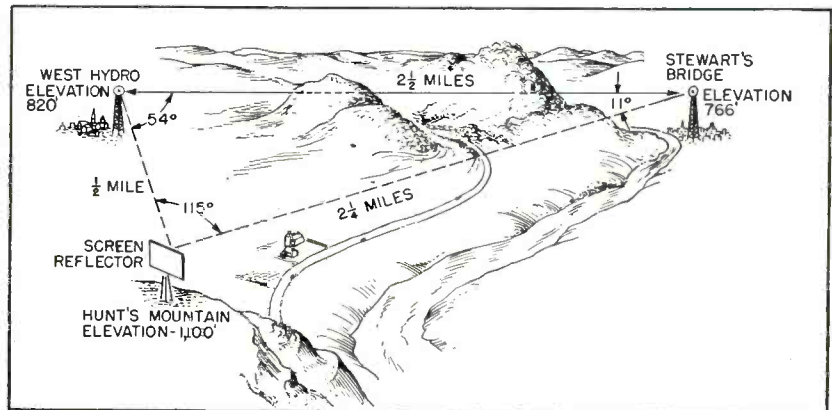

FIG. 2—Plan view of test location. Two mountain obstructions project approximately 90 and 30 feet above direct line-of-sight path

$X$  — the loss that would exist over a direct path of distance  $D$  between the two terminal antennas of area  $A_1$   
 $Y$  — A fictitious loss over distance  $D$  using antenna area  $A_2$   
 $Z$  — A fictitious gain determined by the relative position of the passive repeater  
 Of these,  $X$  and  $Y$  can be readily determined from Bullington's charts<sup>2</sup>, from the above formula directly, or from special formulas developed for a particular application, such as the following one for

use at 960 megacycles:

$$\text{Loss db} = 79.7 - 40 \log d/\lambda + 20 \log D_x$$

where  $d/\lambda$  is the diameter in wavelengths of the parabolic reflector, and  $D_x$  is distance  $D_1$  or  $D_2$  in miles. Then  $Z$  can be determined from Table I which shows db gain versus the position of the passive repeater. The total circuit loss is then the algebraic sum of  $X$ ,  $Y$  and  $Z$  expressed in db. It is interesting to note that  $Y$  and  $Z$  will not cancel except at extremely small values where the limit of accuracy of the

basic equation is approached, or when  $D_1 \geq \frac{2A^2}{\lambda}$ ,  $A$  being the largest dimension of either antenna.

From Table I it is seen that if the distance from a power station to a more advantageously located spot is small compared to the distance to the next relay point, a passive repeater might be used to advantage.

## Experimental Tests

To check the feasibility of using a flat reflector, a 1.3-mile circuit



was set up using a commercially available 960-mc transmitter and receiver. A flat reflector approximately  $6 \times 8$  ft was mounted on a turntable 500 feet from the transmitter and at right angles to the direct path between the units.

Measurements of received signal strength were made over the direct path, and the antennas were then visually oriented toward the reflector. Observing the received signal strength, an attempt was made to orient both antennas and the reflector for a peak signal at the receiver. However, the massive steel-work in a large bridge and a shipyard near the location of the reflector caused reflected signals of such magnitude that it was impossible to obtain useful data at this location.

To secure conclusive results a site relatively free of highly reflecting surfaces was chosen. Arrangements were made to cooperate with the New York Power and Light Company in running tests over the path shown in Fig. 2, between their Elmer J. West hydro station, near Luzerne, N. Y., and the site of a proposed power station at Stewart's Bridge, some  $2\frac{1}{2}$  miles away. Due to the direct path having an excess loss of approximately 35 db above free space value, it appeared that unwanted reflections would be of small magnitude, and so would not be particularly troublesome.

The site picked for the reflector location was on Hunt's Mountain, one-half mile from the receiver location at West Hydro and  $2\frac{1}{4}$  miles from the transmitter location at Stewart's Bridge. The reflector position provided good clearance above line of sight to both locations.

The 960-megacycle transmitter was installed on a knoll at Stewart's Bridge in a special housing mounted on a 30-foot pole provided by the power company.

The transmitting dipole with its 40-inch parabolic reflector was mounted just above the transmitter housing, so that a long run of coaxial cable was not necessary.

The receiver at West hydro was connected through 50 feet of  $\frac{3}{8}$ -inch air-dielectric cable to its antenna.

The  $9 \times 10$ -foot reflector was constructed of  $\frac{3}{8}$ -inch mesh galvan-

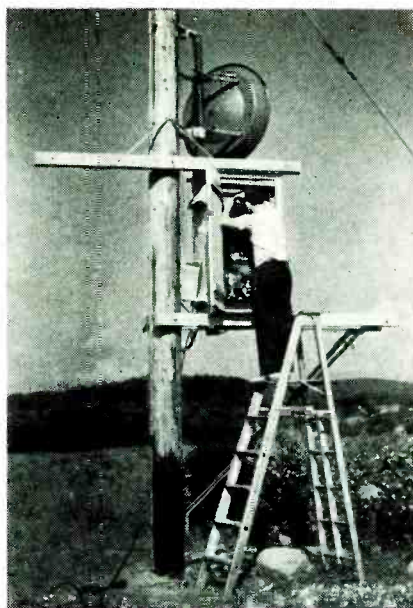

Transmitter is mounted in weatherproof box at Stewart's Bridge location to avoid high losses in a transmission line at 960 mc

ized screening. It was located on top of Hunt's Mountain. The location was such that about 50 percent of the screen area was effective, as the angle between the direct and reflected beam was approximately 115 degrees. The screen openings were small compared to  $\lambda/4$ , which is about 3 inches at 960 mc, so the screen behaved as a solid sheet.

Tests were first made to determine the r-f loss over the direct path from transmitter to receiver. The measured overall loss was 134 db, while calculated loss for this path was 139 db. The difference of 5 db is considered to be well within the limits of accuracy for a path of this type at these frequencies.

Due to the magnitude of this loss, it was felt that the test could be continued without having to consider multipath reflections or energy from the side lobes of the antenna, particularly since the parabola beamwidth was 20 degrees to its half-power points, and the parabolas would be aimed away from the direct path by an angle of 54 degrees at one end, and 11 degrees at the other end.

The parabolas were then aimed at Hunt's Mountain, and the net loss from transmitter to receiver over this path using the mountain itself as a reflector was 109 db. Next the reflector was raised into position and a careful orientation of both

parabolas and the reflector was again made. The net loss then dropped to 106 db, indicating a reflector gain of 3 db.

From the formula developed at the first of this article, the loss using the passive repeater came out as 106.5 db. The same loss was obtained using another formula for the use of passive repeaters<sup>3</sup>.

### Conclusions

Due to the inaccessibility of the reflector position on Hunt's Mountain and the necessity of carrying out other tests, no attempt was made to use a larger reflector. The test did indicate, however, that under certain conditions the use of a reflector is justified.

Nevertheless, the use of a reflector cannot be regarded as being the solution in all likely locations, since in many cases a very large and heavy framework would be required. Also, orientation of the reflector both in azimuth and elevation was found to be quite critical. At many sites these factors would prohibit the use of a large and unwieldy reflector, not only from the standpoint of erection, orientation, and then anchoring the structure, once the correct orientation was secured, but also the problems of getting materials to the site.

The use of a passive repeater is an item to be considered in systems planning but, as in the case of all elements of a system, it must be able to justify itself economically, both in capital investment and in maintenance costs.

Acknowledgment is made to the New York Power and Light Company for its cooperation in these tests, and particularly to Wesley Baylis of that Company, who assisted directly in the test setup and accumulation of the test figures; also to B. F. Wheeler of the Engineering Products Department, RCA Victor Division, under whose supervision these tests were made.

### REFERENCES

- (1) H. T. Friis, A Note on a Simple Transmission Formula, *Proc. IRE*, May 1946.
- (2) K. Bullington, Radio Propagation above 30 Megacycles, *Proc. IRE*, Oct. 1947.
- (3) Pattison, Reagan, Leyland and Gunter, Field Testing a Microwave Channel for Voice Communication, Relaying, Telemetering and Supervisory Control, AIEE Technical Paper 50-151.



## CINCH MICRO CONNECTORS

. . . designed and made of materials as desired to Armed Forces installation requirements.

"What you want when you want it" assured by the production methods that have made "Cinch Standard" in electronic components.

Molded general purpose connectors from three to fifty contacts available in low-loss mica, or melamine for chassis mounting or assembled with cap for cable applications, terminals gold or silver plated. Cinch experience indicated in the wide variety of designs and materials assures you the connector for your purpose. Consult Cinch.

Available at leading electronic jobbers—everywhere.



**Cinch**  
ELECTRONIC  
COMPONENTS

**CINCH MANUFACTURING CORPORATION**

1026 South Homan Ave., Chicago 24, Illinois

Subsidiary of United-Carr Fastener Corporation, Cambridge, Mass.



# SERVO POWER CALCULATIONS

Chart gives required shaft output power in watts for any combination of speed and torque of subfractional motors in tube-driven servo systems. Alternative slide rule method of finding power is also given

**S**ERVO SYSTEM calculations must of necessity start with motor shaft output power to perform the specified work in a specified time. This involves the speed of shaft rotation and the torque required to perform the work. Since motors used in servo systems are usually sub-

By **OSCAR E. CARLSON**

*Vice-President  
Servo-Tek Products Co.  
Paterson, N. J.*

fractional sizes, the horsepower unit is clumsy and awkward for expressing output power. Watts of output has become a common

means of expressing such power requirements.

The conversion of speed and torque requirements to a wattage equivalent is a simple arithmetical computation, but its very simplicity lends itself to even more simplified computation. The equations are

$$\text{Horsepower} = \frac{\text{rpm} \times \text{lb per in.}}{63,000}$$

$$\begin{aligned} \text{Watts} &= \frac{746 \times \text{rpm} \times \text{lb per in.}}{63,000} \\ &= \frac{\text{rpm} \times \text{lb per in.}}{84.4} \end{aligned}$$

This last equation may readily be laid out on a loglog chart so that the rpm x lb per in. factor may be translated into watts quite simply. The accompanying chart does this.

As with most loglog coordinate charts, a slide rule may be utilized for these calculations without using the slider. Set the righthand 1 of the B scale under 8.44 in the righthand log cycle of the A scale, as shown below the chart. With the A scale now representing rpm x lb per inch from 10 to 1,000, the wattage may be read directly under that product on the B scale, with that scale reading from 0.1 to 10 watts. A multiplier of 10 or 100 may of course be used to make calculations up to 1,000 watts, if so required.

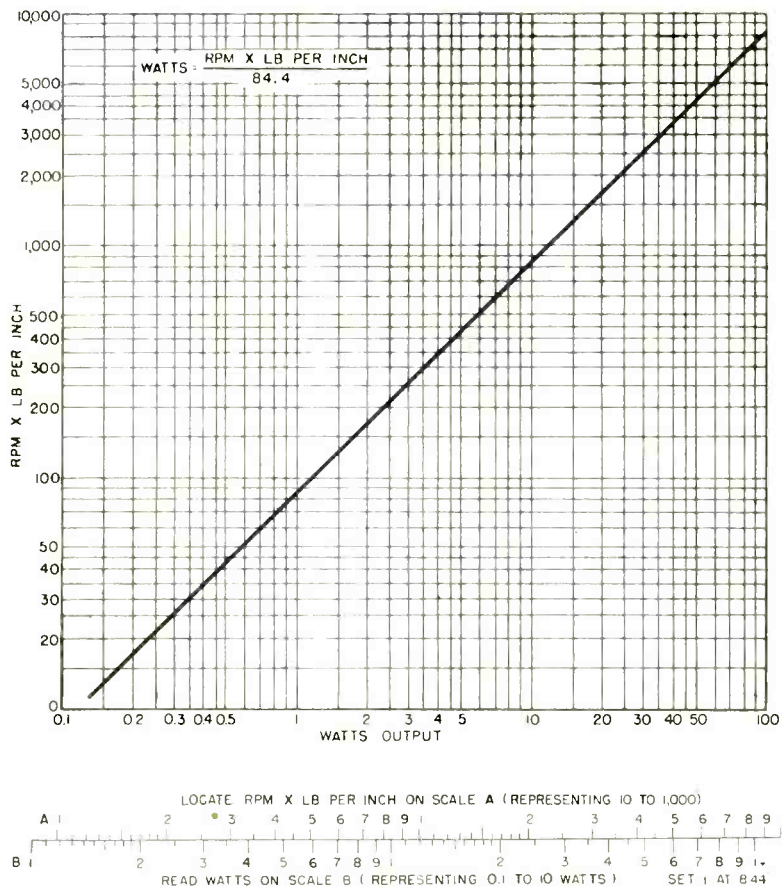

**Value  
Beyond  
Expectation!**

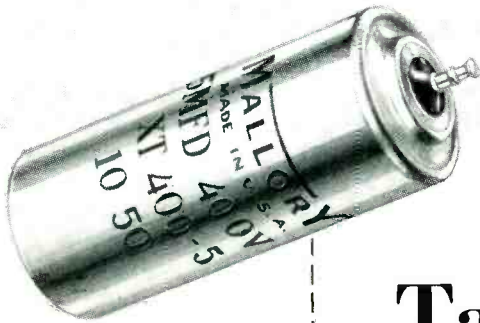

Solidifying temperature  
of many oils.

Greater than the melting  
point of some solders.

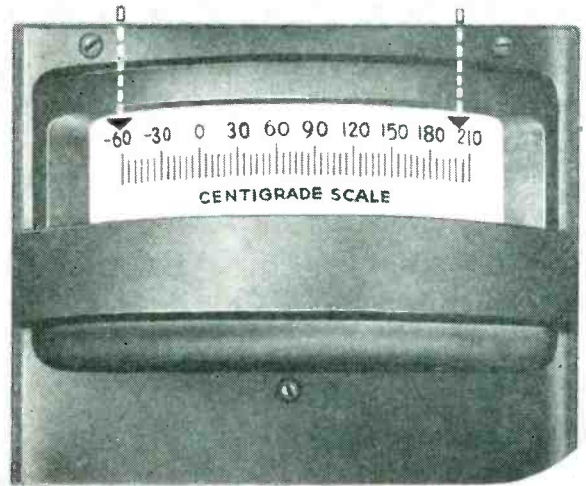

# Mallory Tantalum Capacitor

*Gives Plus Performance  
Over Extreme Temperature Range*

A new Technical Information Bulletin has been prepared to give you detailed specifications on the Mallory XT Tantalum Capacitor. Included are details on Sizes, Mounting Arrangements and Surge Voltages... as well as a complete set of performance curves on capacitance, impedance and resistance under a wide range of temperature conditions.

After more than eight years of research and development, Mallory engineering has succeeded in perfecting a capacitor that operates continuously from  $-60^{\circ}$  to  $+200^{\circ}$  C.

The new Mallory XT Tantalum Capacitor is ideal for use in a wide range of applications... particularly those included in the trend toward smaller, more compact electronic assemblies. Miniaturization makes unprecedented demands upon individual components and usually reflects a marked increase in the total heat generated. The Mallory Tantalum Capacitor, available in a variety of ratings of the single section type, serves well under extremes of both high and low temperature conditions... a plus performance that affords greater dependability in critical services.

*That's value beyond expectation!*

Mallory capacitor know-how is at your disposal. What Mallory has done for others can be done for you.

**P. R. MALLORY & CO., Inc.**  
**MALLORY**

**P. R. MALLORY & CO., Inc., INDIANAPOLIS 6, INDIANA**

#### SERVING INDUSTRY WITH

Electromechanical Products

Resistors      Switches  
TV Tuners      Vibrators

Electrochemical Products

Capacitors      Rectifiers  
Mercury Dry Batteries

Metallurgical Products

Contacts      Special Metals  
Welding Materials



# TUBES AT WORK

Including INDUSTRIAL CONTROL

Edited by RONALD K. JURGEN

Bolometer Amplifier for Microwave Measurements.....	136
The Front Cover.....	138
Improved Antenna Pattern Measurement Facilities.....	138
Graphic Recorders with Fixed Styli.....	162
Need for Improvement in Selenium Rectifiers.....	182
Emergency Wire-Line to Radio Circuits.....	194
Vibrator Power Supplies for Railroads.....	214
Facsimile Reproduction for AEC Library Service.....	222

## Bolometer Amplifier for Microwave Measurements

DESIGN AND TESTING of antenna systems and various r-f networks in the microwave regions requires reliable test equipment for determining relative or absolute r-f field strengths. A modulated or pulsed r-f signal is applied to the network and measurements are usually made by using a crystal or bolometer in conjunction with a probe to yield an output voltage  $e = kE^x$  where  $E$  is the absolute field intensity in the vicinity of the probe,  $k$  is a constant which depends upon the probe configurations and units in which  $e$  and  $E$  are expressed and  $x$  is a function which depends upon the crystal or bolometer and generally will differ somewhat from a constant.

Because the output voltage level of the probing devices is low, it is necessary to amplify their outputs before they are metered. The bolometer amplifier, manufactured by Pickard and Burns, Inc., of Needham, Mass., incorporates a tunable variable-bandwidth filter, an eighth power voltage ratio expander, automatic normalization of input signals and an undecaded output voltage for operating automatic recording equipments.

### Operating Principle

The instrument functions on a heterodyne system in which the input voltages to both the signal and

monitor input channels are converted in balanced modulators to a 50-kc i-f, see block diagram in Fig. 1. The output of the balanced modulator in the monitor channel is amplified and detected to supply bias voltage for the controlled amplifier of the signal channel which provides the automatic normaliza-

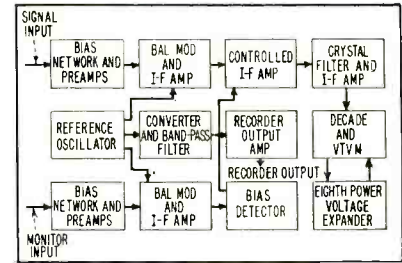

FIG. 1.—Block diagram of the Pickard and Burns bolometer amplifier

tion of voltages in the signal channel.

Output of the balanced modulator in the signal channel is amplified in the controlled amplifier and then fed to the crystal filter and i-f amplifier. The output from the i-f amplifier is connected to the meter decade. Following the decade is the meter amplifier and logarithmic voltmeter.

By switching the input of the expander circuit into the output of the decade and the output of the expander into the input of the voltmeter amplifier, eighth power voltage ratio expansion may be obtained. To provide a recorder output voltage, the output of the i-f amplifier following the crystal filter is fed simultaneously to the meter decade and to a converter and band-

## RADIO-CONTROLLED CADDY CART CUTS GRASS



Jim Walker of Portland, Oregon, shown with a radio-controlled caddy cart and lawn mower which he designed. In his right hand is a small unit for controlling the machines from small distances. In his left hand is a unit for operating and controlling the machines for distances up to two miles

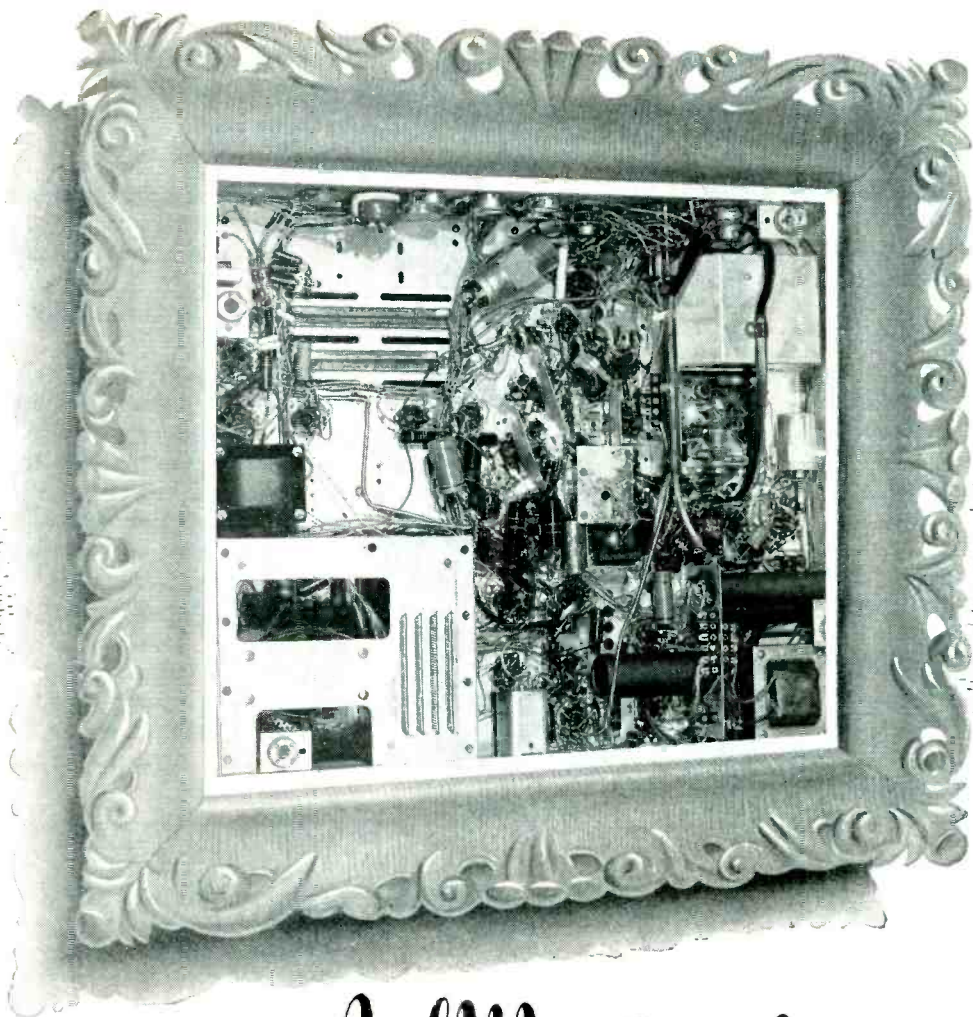

# A Masterpiece

**COMPLEX, EFFICIENT . . . KESTER SOLDER MAKES IT POSSIBLE**

Good fast work can only be done with the best materials. Kester Plastic Rosin-Core Solder and the more active Kester "Resin-Five" Core Solder, made only from newly mined grade A Tin and Virgin Lead, are formulated especially for TV, radio, and electrical work. Kester Solders flow better . . . handle easier . . . faster to use.

**Free Technical Manual**—Send for your copy of "SOLDER and Soldering Technique."

**KESTER SOLDER COMPANY**  
4204 Wrightwood Ave., Chicago 39, Ill.  
Newark, N. J. • Brantford, Canada



SAVES TIME

DEPENDABLE

EASIER TO USE

FASTER



**KESTER  
SOLDER**



pass filters, the output of which is then amplified and connected to the recorder output terminal.

When the bolometer amplifier is functioning with linear amplification, the decade output is amplified in the meter amplifier. The output voltage is rectified and metered on the output meter which is calibrated in a-c volts. On expand operation, the output of the decade is multiplied in the eighth power voltage ratio expander circuit to a 400-kc voltage which is then amplified in the meter amplifier, rectified and metered on the output meter.

#### Instrument Description

Nominal frequency range of the instrument is 400 to 5,000 cycles with the frequency dial calibrated directly in cycles. Bandwidths are selected by a switch and are 6, 12, 22, 50, 100 and 300 cycles. Input impedance is between 250 and 350 ohms for all frequencies between 400 and 5,000 cycles.

The indicating voltmeter has a logarithmic scale and is calibrated in both volts and decibels. The decade used in conjunction with the meter is calibrated in volts full scale and is adjusted in 20-db steps from 0.01 volt full scale to 100 volts full scale.

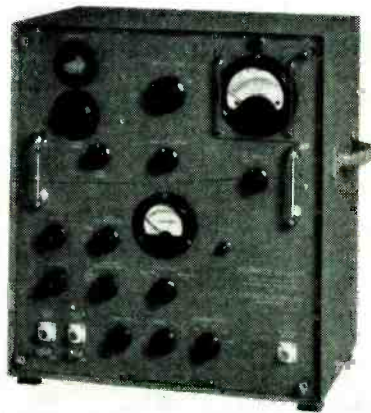

**Bolometer amplifier for use in microwave field-intensity measurements**

Output voltage for recording purposes is 80 db undecaded. This output is at the input frequency and is at an impedance level of approximately 50,000 ohms. Loading up to 0.01 watt maximum is permissible without causing nonlinear amplification in the output.—R.K.J.

## THE FRONT COVER

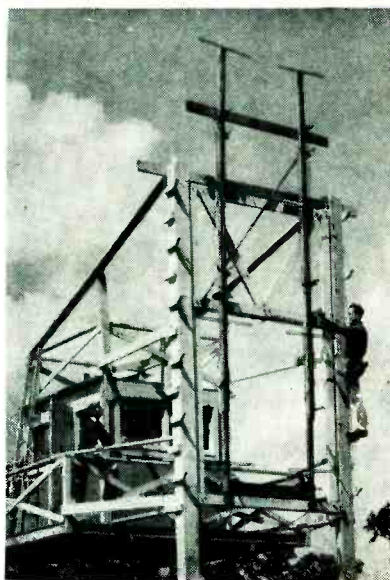

**C**RITICAL MEASUREMENTS are made at the Andrew Corporation's 800-acre research facilities in Orland Park, Illinois, with the aid of this 35-foot testing structure.

The height of arrays is readily varied by means of a sliding frame. Antennas are tested by mounting at the top of a 40-foot high rotating mast which is inside a building not visible in the picture. Directional antennas are then placed on the testing structure. The field pattern of the inside antenna is measured by rotating the mast and exciting the directional antennas outside (for further description see article by M. W. Scheldorf on this page).

## Improved Antenna Pattern Measurement Facilities

BY M. W. SCHELDORF  
Head Research Engineer  
Andrew Corporation  
Orland Park, Illinois

CHARACTERISTICS OF AN ANTENNA are essentially defined by its two principal qualities, input impedance and radiation patterns. It is generally understood that electrical measurements to determine these characteristics must be made without reflections from structures in the vicinity of the antenna. This is particularly true of pattern measurements where reflected signals contribute to errors in the first order as compared with impedance measurements where these errors appear as second order effects.

Patterns are taken in two ways. In one method, a signal is applied to the antenna under test (rotatable in the plane desired) and the field is measured by a second fixed antenna, (similar to the test antenna but often only a dipole antenna or special directive antenna). In a second method, a fixed field is established by a source antenna and the test antenna is rotated in this field. Measurements are then made of the voltage received. Due to a condition of reciprocity, the results obtained

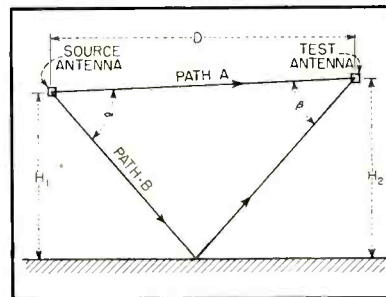

**FIG. 1—Ground reflection diagram for test antenna setup**

are the same for both methods.

When operating at very short wavelengths it is possible to rotate the test antenna in either a vertical plane or a horizontal plane so as to obtain the commonly accepted standard patterns, but due to ground reflections, it is usually preferable to rotate it in only the horizontal plane, see Fig. 1.

In most pattern tests it is possible to avoid all reflections except the ground reflection and the conditions as indicated in this figure are met. Radiation from one antenna to the other takes place over two general paths, one directly between them, path A, and another by virtue of a ground reflection, path B. Two

(Continued on p 158)

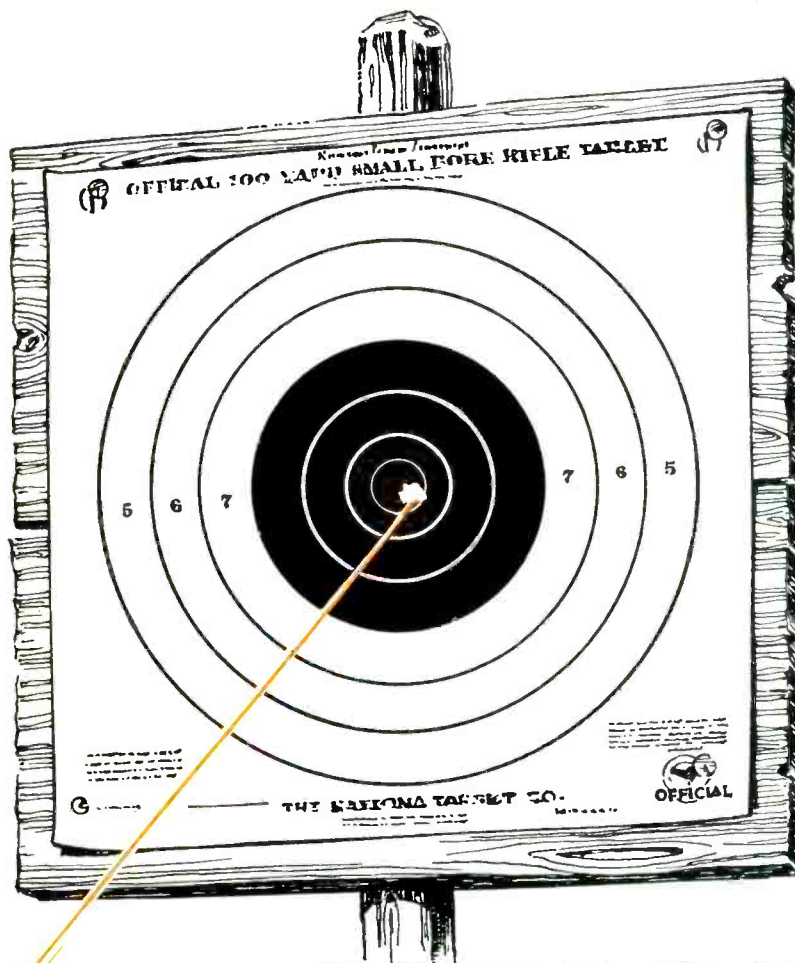

# BULLS-EYE !

**Y**ou hit the bulls-eye when you call upon Sprague application engineers to help you with critical capacitor problems.

Skilled in applying the essentials of capacitor design to save space and cost in complex military and civilian electronic equipment, Sprague engineers are ready to serve you.

If standard capacitors can solve your problem, they have the industry's most complete

line from which to recommend. If you need a special electrical or mechanical design to best solve your circuit or production problems, they will gladly work out the details without cost or obligation.

Time is of the essence today. If you have a capacitor, interference filter, or pulse network problem, contact SPRAGUE by 'phone, wire, or mail without delay.

# SPRAGUE

PIONEERS IN

**SPRAGUE ELECTRIC COMPANY**

NORTH ADAMS, MASSACHUSETTS

ELECTRIC AND ELECTRONIC DEVELOPMENT

SEE US AT BOOTHS 27-28, I. R. E. SHOW



# THE ELECTRON ART

Edited by JAMES D. FAHNESTOCK

Transistor Frequency-Multiplying Circuit.....	140
Extending Range of Light Microscope with Television.....	142
Improving Loudspeaker Response with Motional Feedback.....	142
Voltmeter-Ammeter for Determining Characteristics of Nonlinear Devices.....	240
Compact Digital Differential Analyzer.....	244
Tuning Systems Employing Feedback Amplifiers.....	252

## Transistor Frequency—Multiplying Circuit

By W. B. BOWERS\*

The W. L. Maxson Corporation  
New York, N. Y.

THE FOLLOWING DESCRIBES a recently developed electrical network for direct, rapid and accurate multiplications of two voltages, which may go through zero, by utilization of special characteristics of crystal triodes, such as Western Electric Type A Transistors. The electrical network, which may be used for related mathematical operations as well as multiplication, does not contain vacuum tubes or other parts requiring periodic replacement. The network is extremely small, simple to construct, and may be expected to operate under conditions of severe vibration and shock. Operation from zero frequency to 10 megacycles is possible.

Figure 1A shows the basic circuit of a crystal-triode multiplying device. The basic circuit as shown is also that of a crystal-triode amplifier already in wide experimental use. When the circuit is applied as an amplifier, it is generally utilized as follows:

A constant potential, negative with respect to the potential of the common bus, is applied to the collector of the crystal triode through resistor,  $R_3$ . The potential applied to the collector and the ohmic value of  $R_3$  are selected primarily for high gain. The input signal to be

amplified is supplied to the emitter circuit at the junction of  $R_1$  and  $R_2$ . The resistors in the emitter circuit,  $R_1$  and  $R_2$ , limit the emitter bias current. The emitter bias current is adjusted as required to attain high gain and low distortion products in the output signal. When used for a-c amplification, blocking capacitors may be installed in the amplifier input and output circuits so as to prevent the d-c bias and collector voltages from producing direct currents in the external input and load circuits,

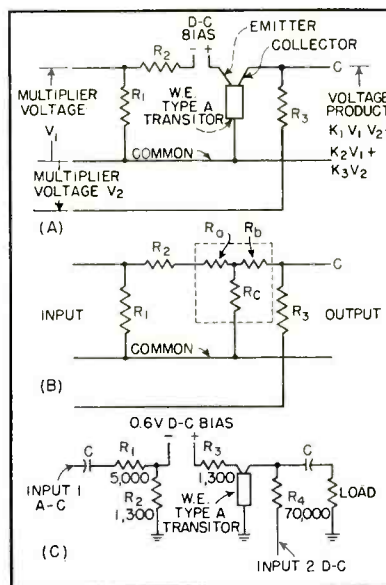

Fig. 1—Circuit and equivalent for transistor amplifier and frequency multiplier

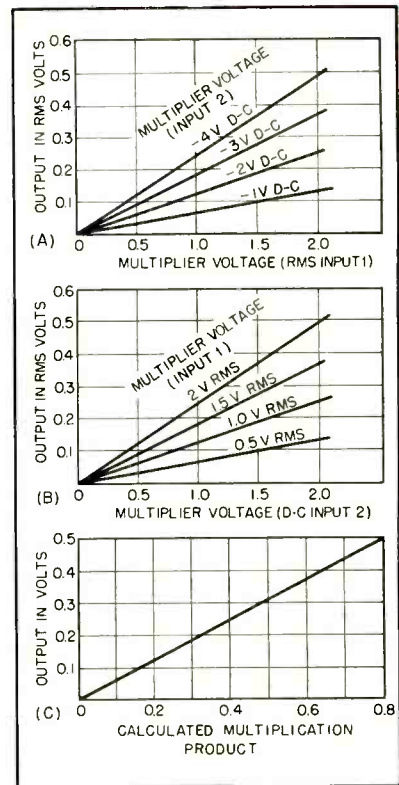

Fig. 2—Curves show characteristics of transistor used as frequency multiplier

as illustrated in Fig. 1C.

In applying the circuit of Fig. 1A as a multiplier, the emitter bias is adjusted so as to obtain a direct proportionality between collector voltage and output voltage for a range of input voltages. Because the effective equivalent impedance of a crystal triode, such as a Western Electric Type A Transistor, at frequencies below 10 megacycles is that of a tee resistance pad (see Fig. 1B), the output voltage may be expressed mathematically in terms of the input voltages as follows:

$$\text{Output voltage} = V_o = K_1V_1V_2 + K_2V_1 + K_3V_2$$

where  $V_1$  and  $V_2$  are the multiplier voltages applied to emitter and collector circuits respectively,  $K_1V_1V_2$  is the product of the multiplication,  $K_2V_1$  and  $K_3V_2$  are undesirable by-products which may be eliminated by balancing circuits, by blocking capacitors (in a-c multiplying circuits) or by other conventional circuit means, and  $K_1$ ,  $K_2$  and  $K_3$  are constants.

Figure 1C shows a practical multiplying circuit. This circuit will provide accurate multiplication of

\* Work done while author was with Fairchild Guided Missiles Division, Farmingdale, N. Y.

# For the Measurement of Q and Inductance

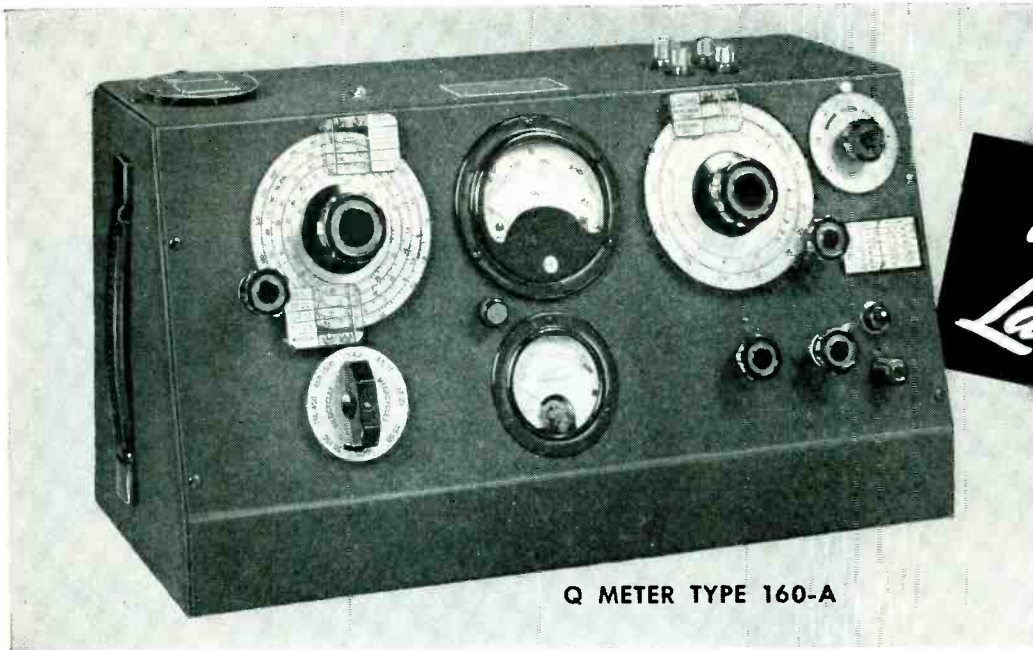

Q METER TYPE 160-A

*in the  
Laboratory*

*on the Production Line*

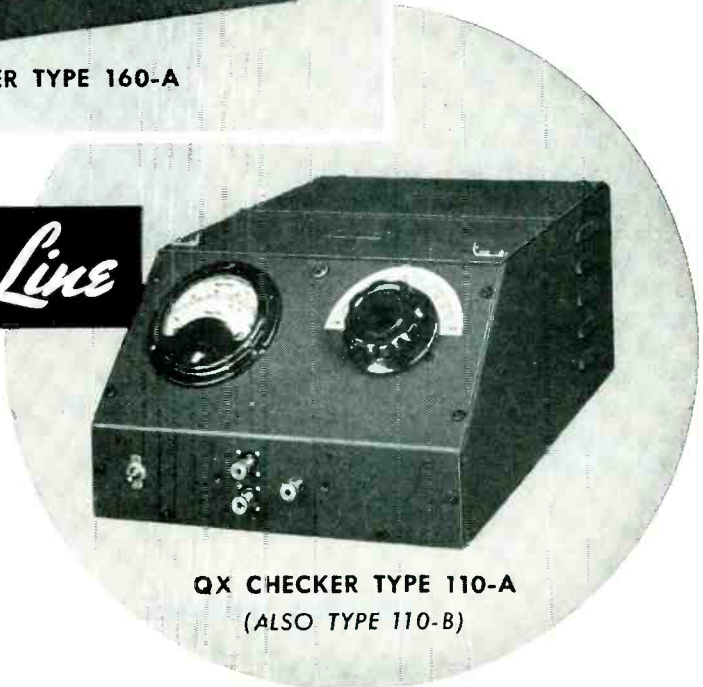

QX CHECKER TYPE 110-A  
(ALSO TYPE 110-B)

The Type 160-A Q-Meter offers the electronic engineer a simple, reliable means of measuring Q, inductance, and capacitance, at any frequency within the range of 50 kc. to 75 mc. Each component part and assembly used in the manufacture of this instrument is designed with the utmost care and exactness. Circuit tolerances are held to values obtainable only in custom built instruments.

The Type 110-A QX-Checker has been designed as the production counterpart of the Type 160-A Q-Meter to rapidly and accurately compare the relative Q and reactance of components with established standards. Manufacturers of television receivers and those engaged in producing R. F. components will appreciate the time and effort saved by employing this unit for production line use or at incoming inspection points.

Be sure to include both of these versatile and dependable instruments in your new equipment plans for 1951.

### 160-A Q-METER SPECIFICATIONS

OSCILLATOR FREQUENCY RANGE: 50 kc. to 75 mc. in 8 ranges.  
OSCILLATOR FREQUENCY ACCURACY:  $\pm 1\%$ , 50 kc.—50 mc.  
 $\pm 3\%$ , 50 mc.—75 mc.

Q MEASUREMENT RANGE: Directly calibrated in Q, 20-250. "Multiply-Q-By" Meter calibrated at intervals from x1 to x2, and also at x2.5, extending Q range to 625.

(In Canada, direct inquiries to RCA Victor Co., Ltd., Montreal)

**BOONTON RADIO**

BOONTON · N · J · U · S · A



Q MEASUREMENT ACCURACY: Approximately 5% for direct reading measurement, for frequencies up to 30 mc. Accuracy less at higher frequencies.

CAPACITANCE CALIBRATION RANGE: Main capacitor section 30-450 mmf, accuracy 1% or 1 mmf whichever is greater. Vernier capacitor section +3 mmf, zero, -3 mmf, calibrated in 0.1 mmf steps. Accuracy  $\pm 0.1$  mmf.

### 110-A QX-CHECKER SPECIFICATIONS

FREQUENCY RANGE: 100 kc. to 25 mc. in 6 ranges using plug-in coils.  
ACCURACY OF COIL CHECKS: May be checked against standard to within about 0.2% with coil values of 10 microhenries to 10 millihenries and Q of 100 or greater.

CAPACITANCE RANGE: Capacitance values ranging between approximately 2-1000 mmf may be checked against a standard to an accuracy of a few tenths of one mmf if the Q of the capacitor is high.

TYPE 110-B QX-CHECKER also available for accurate comparison of very small inductors.

DESIGNERS AND MANUFACTURERS OF THE Q METER · QX CHECKER  
FREQUENCY MODULATED SIGNAL GENERATOR · BEAT FREQUENCY  
GENERATOR AND OTHER DIRECT READING INSTRUMENTS



an a-c signal from zero to two volts with a d-c signal of negative polarity from zero to four volts.

For this circuit  $K_1$  was measured as approximately 1/16. Voltage  $K_2V_2$  was eliminated by a blocking

capacitor. Constant  $K_2$  was measured as 0.015; however, the output product  $K_2V_1$  can be eliminated by a balancing circuit not shown. Figures 2A and 2B show output voltage products as a function of the ap-

plied multiplier voltages. Figure 2C shows measured versus computed product voltages. The measured voltages were chosen at random from the points on Fig. 2A and 2B.

## Extending Range of Light Microscope With Television

SIGNIFICANT EXTENSION of the range, power and versatility of the light microscope is made possible through the use of a television link between the microscope and the human eye. The new technique of television microscopy, since it enables the interchanging of television camera tubes with sensitivities to different wavelengths of light, provides considerably sharper contrast than previously available.

The photograph shows the new system in use. According to Princeton University's A. K. Parpart, who demonstrated the RCA equipment, the television-microscope combination makes possible the study of many components of living cells normally visible only after killing and staining, and also the direct observation of motion of, and within, these cells at high magnifications.

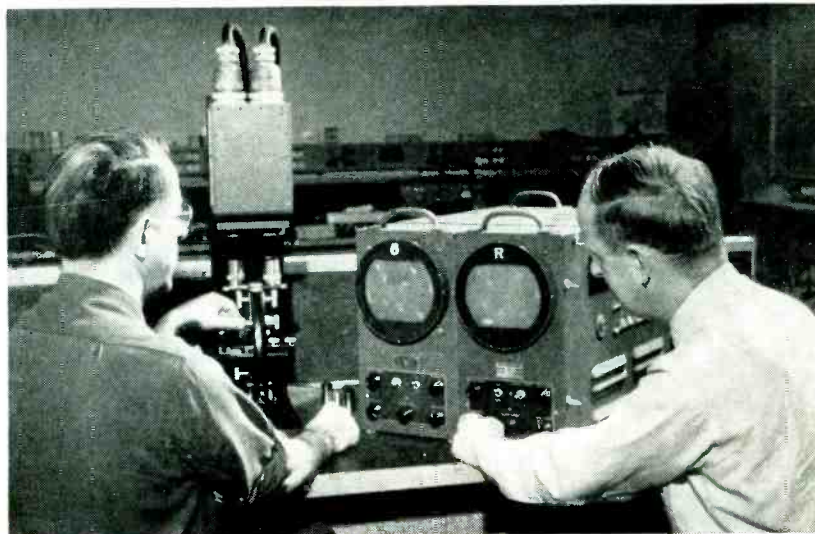

Television link extends range and versatility of light microscope and allows studies to be made that were hitherto impossible

The system is also useful for demonstration purposes, where a group is to study a microscope image.

The binocular camera unit, shown in the photograph, employs two Vidicons, each sensitized for different wavelengths.

## Improving Loudspeaker Response with Motional Feedback

BY ROBERT L. TANNER  
Stanford University  
Stanford, California

A FACTOR OF IMPORTANCE in determining the response of loudspeakers, and one usually given insufficient consideration in design, is the effective driving source impedance. The mechanical system of a loudspeaker has the electrical analog<sup>1</sup> shown in Fig. 1. This equivalent circuit is based on the similarity between the differential equations of motion for the loudspeaker and the Kirchhoff circuit equations for the series resonant circuit of the figure. In the analogy the mass of the moving system (cone, voice coil, and air load) is represented by  $M$ , the compliance of the suspension by  $C$ , and the total dissipation (energy lost in flexing the suspension

Table I—Mechanical and Magnetic Data for Adding Motional Feedback to Amplifier-Speaker Combination for Typical Loudspeakers

Speaker Type	Diameter (inches)	Magnet	Voice Coil Resistance (ohms)	Resonant Frequency (cps)	Effective Mass Including Air Load with Baffle (Grams)	Compliance of Suspension (cm per dyne)	Mechanical Q	Magnetic Conversion Factor $\frac{B^2 l^2}{10^9}$
Cinaud. P8J1	8	6.8 oz Alnico V	6.5	113	9.45	$2.1 \times 10^{-7}$	15	$3.60 \times 10^4$
GE S810D	8	6.8 oz Alnico V	3.2	115	9.7	$1.98 \times 10^{-7}$	9.6	$1.38 \times 10^4$
Unknown	8	21 oz Alnico III	6.5	118	9.4	$1.93 \times 10^{-7}$	18	$1.82 \times 10^4$
Cinaud. P6F1	6	3.16 oz Alnico V	2.95	140	5.50	$2.35 \times 10^{-7}$	17	$6.65 \times 10^3$
Unknown	6	1.47 oz Alnico V	2.75	136	3.6	$3.78 \times 10^{-7}$	12	$2.12 \times 10^3$

plus energy radiated) by  $R$ . The mechanical constants of the system relate the velocity of motion to the

applied force in a manner mathematically identical to the way in

(Continued on page 228)

# Another **FIRST** by **RMC** Temperature Compensating and General Purpose DISCAPS

Available Range		Available Range		Available Range		Available Range		Available Range	
MMF	TC	MMF	TC	MMF	TC	MMF	TC	MMF	TC
—	—	2 to 9	P100	10 to 30	P100	—	—	—	—
5 to 15	NPO	16 to 33	NPO	31 to 60	NPO	61 to 75	NPO	61 to 75	NPO
5 to 15	N33	16 to 30	N33	31 to 60	N33	61 to 75	N33	61 to 75	N33
5 to 15	N75	16 to 30	N75	31 to 60	N75	61 to 75	N75	61 to 75	N75
5 to 15	N150	16 to 30	N150	31 to 60	N150	61 to 75	N150	61 to 75	N150
5 to 15	N220	16 to 30	N220	31 to 75	N220	76 to 100	N220	76 to 100	N220
5 to 15	N330	16 to 30	N330	31 to 75	N330	76 to 100	N330	76 to 100	N330
5 to 20	N470	21 to 40	N470	41 to 100	N470	101 to 125	N470	101 to 125	N470
10 to 25	N750	26 to 50	N750	51 to 150	N750	151 to 200	N750	151 to 200	N750
15 to 50	N1500	51 to 80	N1500	81 to 200	N1500	201 to 250	N1500	201 to 250	N1500
50 to 100	N2200	100 to 150	N2200	150 to 250	N2200	250 to 300	N2200	250 to 300	N2200



Body Size 1/4" Dia.

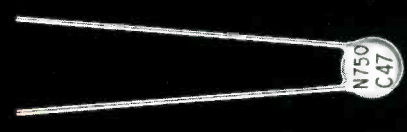

Body Size 5/16" Dia.

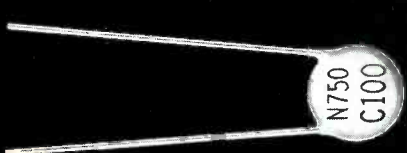

Body Size 1/2" Dia.

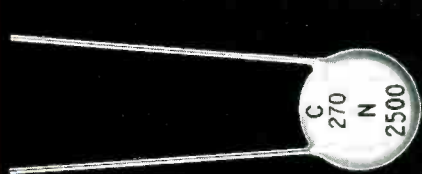

Body Size 5/8" Dia.

### Specifications

**POWER FACTOR:** LESS THAN .1% AT 1 MEGACYCLE  
**WORKING VOLTAGE:** 600 VDC TEST VOLTAGE 1200 VDC  
**DIELECTRIC CONSTANT:** P-100 14K N-750 88K  
 N-2200 265K NPO 35K N1500 165K  
**CODING:** CAPACITY, TOLERANCE AND TC STAMPED ON DISC  
**INSULATION:** DUREZ PHENOLIC—VACUUM WAXED  
**MIN. LEAKAGE RESISTANCE:** INITIAL 5000 MEGOHMS  
 AFTER HUMIDITY 1000 MEGOHMS  
**LEADS:** #22 TINNED COPPER (.026 DIA.)  
**LEAD LENGTH:** 1/4" BODY 1", 5/16" BODY 1-1/4",  
 1/2" BODY 1-1/2"  
**TOLERANCES:** ±5% ±10% ±20%

SEE US — BOOTH 338 — I. R. E. SHOW

## Designed to Replace Tubular Ceramic and Mica Condensers at LOWER COST

RMC Type C DISCAPS conform to the electrical specifications of the RMA RC-107 standard for Class 1 ceramic capacitors. Their capacity will not change under voltage.

Type C DISCAPS offer for the first time low inductance, disc type temperature compensating ceramic condensers which are ideally suited to coupling and tuned circuit applications. Because they are available in a wide range of capacities and temperature coefficients, their usefulness is practically unlimited.

If you are interested in improving the uniformity of your product you will be interested in RMC DISCAPS.

**SEND FOR SAMPLES AND TECHNICAL DATA**



**DISCAP CERAMIC CONDENSERS**

RADIO MATERIALS CORPORATION

GENERAL OFFICE: 1708 Belmont Ave., Chicago 13, Ill.

FACTORIES AT CHICAGO, ILL. AND ATTICA, IND.

Two RMC Plants Devoted Exclusively to Ceramic Condensers



# NEW PRODUCTS

Edited by WILLIAM P. O'BRIEN

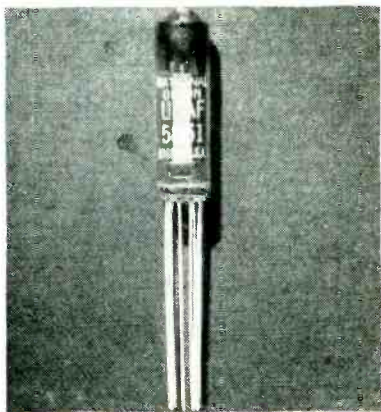

## Tiny Beam Pentode

NATIONAL UNION RADIO CORP., 350 Scotland Road, Orange, N. J. Designed for use in military and other applications where subjected to excessive shock and vibration, the type 5851 subminiature tube is suitable for frequency doubler operation up to 400 mc, producing 120 mw. The filament requires 55-ma current at 2.5 v; and it may also be operated at 1.25 v at 110 ma. Plate dissipation rating is 1.5 watts. As a class-A amplifier it will deliver 650-mw audio output at 10-percent total harmonic distortion.



## Precision Frequency Meter

C. G. CONN LTD., Elkhart, Ind., has announced a new industrial model 6T-4 Stroboconn, a precision frequency meter accurate to 0.05 percent. Unlike older models used in the music industry it is calibrated directly in cps. The new meter is

useful in aircraft engine test work as well as in educational and industrial institutions.



## Metal-Shell Rectangular

RADIO CORP. OF AMERICA, Harrison, N. J., has announced the 17CP4, a new, 17-in., metal-shell, rectangular picture tube for tv receivers. With its design-center maximum anode-voltage rating of 16 kv, it provides pictures having high brightness and good uniformity of focus over the 14 $\frac{1}{2}$  x 11-in. picture area. It employs magnetic focus and magnetic deflection, has a frosted Filterglass face plate and features an improved design of funnel-to-neck section that facilitates centering of the yoke on the neck. Diagonal deflection angle is 70 deg and horizontal deflection angle, 60 deg.

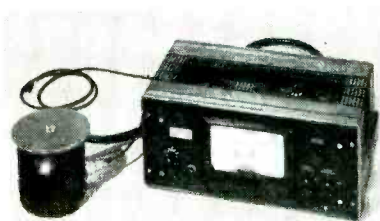

## Electrometer

LOUDON INSTRUMENTS, INC., 5644 Lake Park Ave., Chicago 37, Ill. Designed especially for nuclear research work, model 361-20 dynamic

capacitor electrometer is suitable for general laboratory measurement of small d-c currents and voltages in high-resistance circuits. Typical applications are ionization chamber measurements of radiation potentials, chemical titrations, and insulator and capacitor leakage measurements. The dynamic capacitor (located in a separate hermetically sealed inner shield) eliminates drift. Voltage ranges of the model 361-20 are 0 to 10, 0 to 100 and 0 to 1,000 mv with range selector switch.



## Quartz Monochromator

CAMBRIDGE THERMIONIC CORP., 437 Concord Ave., Cambridge 38, Mass. Those who require a source of monochromatic light for microscopy or other purposes can now secure it in a simple device which utilizes the rotary power of quartz. In the instrument illustrated white light from a tungsten source is passed through basal sections of optical quartz laminated to polaroid sheets. By a synchronous rotation of the quartz sections, the wavelength of transmitted light can be varied continuously through the visible spectrum. The device produces an average bandwidth of 150 Angstrom units.

## Turret Switch TV Tuner

KINGSTON PRODUCTS CORPORATION, Kokomo, Indiana, presents a television tuner that combines features of the turret and the switch type. The basic design is intended to isolate the oscillator from the other

# RAYTHEON

WORLD'S LARGEST MANUFACTURERS OF

AND  
WORLD HEADQUARTERS FOR

## PULSE TYPE MAGNETRONS

Tunable or fixed frequency — 1,000 to 25,000 megacycles — power range from a few watts to several megawatts.

## CW MAGNETRONS

Fixed frequency, tunable and frequency modulated tunable — 1,000 to 10,000 megacycles — power range from a few watts to several kilowatts.

## KLYSTRONS

Integral and external cavity, low power — frequency range, 500 to 50,000 megacycles.

## SPECIAL PURPOSE TUBES\*

Cold-cathode, gas-filled rectifier tubes — ruggedized diodes, triodes and pentodes for aircraft, industrial and military service — voltage regulator, voltage reference and radiation counter (Geiger-Mueller) tubes — germanium crystal diodes.

## SUBMINIATURES\*

Filamentary and cathode type tubes; fit standard sockets or may be soldered or welded into the circuit. Over 40 types—over half a million in stock—available through 310 Raytheon Tube Distributors.

For detailed information, get in touch with

**RAYTHEON MANUFACTURING COMPANY**

Power Tube Division  
WALTHAM 54, MASS.

\*Receiving Tube Division  
NEWTON 58, MASS.

**RAYTHEON**

*Excellence in Electronics*



circuits to minimize radiation. On all channels the circuit is arranged to eliminate common-coupled and M-derived coils for interstage circuits, yet the interstage patterns are identical with those. The tuner is adaptable to several mounting positions and may be fitted to a number of dial drives. Coils are so arranged that individual alignment can be done on any channel without removing the tuner from the chassis.

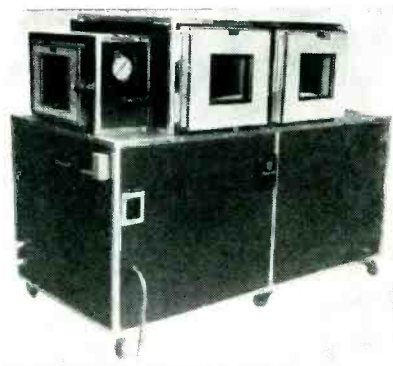

### All-Weather Testing Lab

NORTHERN ZALESKI LTD., Pratt Oval, Glen Cove, N. Y. A new combined all-weather testing laboratory allows manufacturers required to test under test specifications calling for temperatures to  $-100$  F; controlled humidities; high altitudes; and fungus conditions to purchase economically an all-in-one laboratory which combines into one unit, but in separate testing spaces, all of the required features for these tests.

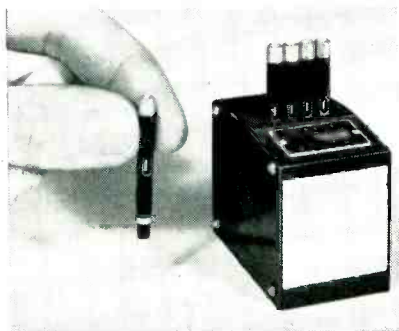

### Supersensitive Galvanometer

MIDWESTERN GEOPHYSICAL LABORATORY, Tulsa, Oklahoma, is manufacturing the model 106-SS galvan-

ometer that is so sensitive it can be used in most applications directly from source without amplification. Normal balance is only 0.003 in. per G at 12-in. focal distance. It has individual circuits for both terminals of the elements. The outside diameter of the element tube is 0.187 in.; the element length, 2.062 in. Price is \$200.

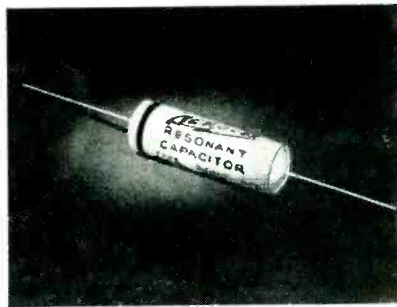

### Resonant Paper Tubulars

AEROVOX CORP., New Bedford, Mass., has made available the type RC resonant paper tubular capacitors that are applied as bypasses to prevent i-f currents or voltages between 425 and 485 kc from circulating. Standard ratings of the new capacitors are: 0.05, 0.1 and 0.2  $\mu$ f, 400 working volts d-c; measuring  $1\frac{1}{2}$  in. x  $\frac{1}{2}$  in.,  $1\frac{1}{2}$  in. x  $\frac{3}{4}$  in., and  $1\frac{1}{2}$  in. x  $9/16$  in., respectively.



### Sweep Frequency Signal Generator

EASTERN ELECTRIC CO., P. O. Box 175, Valley Stream, N. Y. Model 100 sweep frequency signal generator is an electronic, fundamentally operated tv i-f generator for production alignment in the 20-mc range. Maximum sweep width is 16 mc at a center frequency of 25 mc. Amplitude variation is 0.1 db per mc with frequency linearity within 2 percent. Swept r-f output is 0.5 v across a 100-ohm terminated

cable. Three steps of 20, 20 and 10 db plus a linear vernier attenuator are available at the front panel with blanking, phasing and sweep width controls and horizontal scope source.



### Linear Amplifier

NUCLEAR INSTRUMENT AND CHEMICAL CORP., 223 West Erie St., Chicago 10, Ill. Model 1061 linear amplifier was designed to adapt G-M scalers to proportional counting. The instrument is connected between the detector and a scaler, and provides convenient sensitivity adjustment, calibrated in millivolts, with a choice of 1 or 10-mv maximum sensitivity. It has a flat frequency response of 10,000 cycles to 1.5 mc. A set of oscilloscope terminals are located in the front panel while all other connections are on the rear. The instrument is so designed that the scaler may operate independently without disconnecting it from the amplifier.

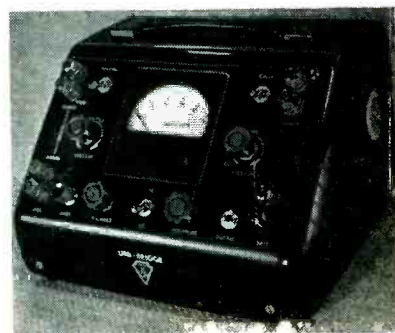

### Power S Bridge

INDUSTRIAL ELECTRIC CO., 1000  
Wheeler St., Joliet, Ill. Model  
Uni-Bridge i

(Continued on p. 60)



Wherever Magnetic  
Recordings Are Made

THE TREND IS TO  
**audiotape\***

made by audio engineers  
for audio engineers

THE EVER GROWING PREFERENCE for Audiotape is largely a matter of *experience*.

Professional recordists started the trend to Audiotape because they knew, from long experience with Audiodiscs®, that Audio could always be depended on for consistent, uniform quality — to meet the most exacting requirements.

And the trend is continuing, in every field of sound recording, because *experience* with Audiotape proves its unequalled uniformity of output and freedom from background noise and distortion.

The superior magnetic and mechanical properties of Audiotape are the *result* of experience, too — more than a decade of engineering and production know-how by the *only* company in America devoted solely to the manufacture of fine sound recording materials — discs, tape and film.

That's why the Audiotape line has grown so large and so fast. In addition to the standard 1/4" tapes, Audio is now supplying a wide variety of special sizes — up to 8" in width — for specialized applications of sound reproduction. The new Audiofilm\*, developed for the motion picture and TV industries, is a typical example.

Whatever your magnetic recording requirements — for standard or special tapes — remember that you can always depend on Audiotape. Get in touch with your nearest Audiotape distributor, or write to our New York office.

\*Trade Mark

**AUDIO DEVICES, INC.**

444 Madison Ave., New York 22, N.Y.

Export Dept.: ROCKE INTERNATIONAL, 12 East 40th St., Rm. 514, N.Y.



# NEWS OF THE INDUSTRY

Edited by WILLIAM P. O'BRIEN

## Graduate Study in Electronics Announced

STANFORD UNIVERSITY, through its Microwave Laboratory, closely associated with the Physics Department, and its Electronics Research Laboratory of the Electrical Engineering Department, is now offering an integrated program of course work and organized research in electronics. The research work, largely staffed by graduate students on part-time employment and sponsored by industry and the government, includes an extensive activity in vacuum-tube development, including klystrons and traveling-wave tubes, a billion-volt electron linear accelerator development, microwave techniques, applications of microwaves to physical research, ionospheric propagation and upper atmosphere studies, and advanced techniques for amplifier and network synthesis.

Fellowship holders register for a full program of study. Eight awards are available, ranging from \$600 to \$1,200. Holders of research assistantships are assigned to the organized projects. Complete information on stipends and qualifica-

tions required is available by writing to Assistantship Committee, Electrical Engineering Dept., Stanford University, Stanford, Calif. Application forms and university bulletins will be sent. To receive full consideration applications should be submitted by March 15, 1951.

## Amateur Bands for Civil Defense

PERMANENT availability of specific frequency bands within the regularly allocated amateur bands for eventual use by amateurs in providing civil defense communication (after any suspension of normal amateur activity which may later be found to be necessary because of war or other national emergency), has been the subject of particular study by the FCC, the Civil Defense Administration and the Armed Forces of the U. S.

After consideration of all factors known to be involved at this time,

including frequency requirements of other radio services in time of war or other national emergency, certain frequency bands already allocated to amateurs have been selected for their retention and use for the purposes described above. The extent to which these bands meet the actual requirements for amateur participation in civil defense communications may be reviewed after a sufficient number of local communities have established appropriate civil defense plans, conducted communications drills or otherwise accumulated data which will permit such a review.

The frequency bands which will remain available for civil defense use by amateurs are: 1,800 to 2,000 kc; 3,500 to 3,510 kc; 3,990 to 4,000 kc; 28.55 to 28.75 mc; 29.45 to 29.65 mc; 50.35 to 50.75 mc; 53.35 to 53.75 mc, 145.17 to 145.71 mc; 146.79 to 147.33 mc; 220 to 225 mc.

In addition to the above bands, the 1,750 to 1,800-kc band will continue to be available for use by properly qualified amateurs and others to provide a Disaster Communications Service, but it should be noted that such a service is intended as a permanent one for use in a disaster occurring at any time, to assist in handling communications within or with a disaster area, whereas the frequencies listed above are designated for amateur use for the handling of such communications as may be required in the interest of civil defense.

## WORLD'S SECOND-HIGHEST MAN-MADE STRUCTURE

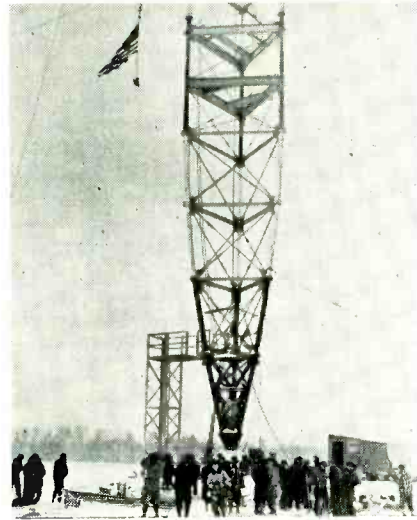
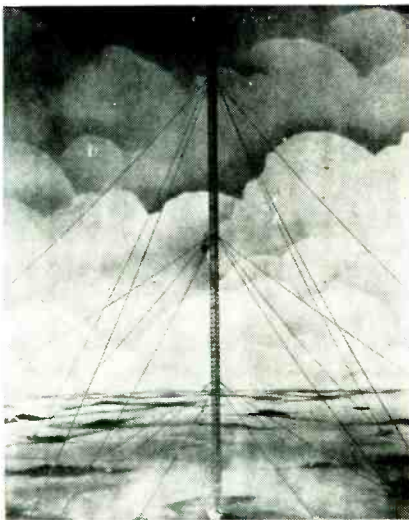

Recently completed giant loran tower at Forestport, N. Y., was built for experimental and development use by the Air Force Electronics Center at Griffiss AFB. Artist's conception is shown at left. Photo at right was taken during flag-raising ceremony upon completion of the steel shaft, which is stated to be in excess of 1,200 feet. More than 1,400 yards of concrete were poured and 772 tons of steel used in construction of the tower, which is supported by 18 steel guy cables. Only Empire State antenna structure is higher

## IRE Convention Program

FOURTEEN professional group symposia and about 150 technical papers will be featured at the IRE annual convention to be held at the Hotel Waldorf Astoria and Grand Central Palace, New York City, from March 19 to 22.

Technical sessions are as follows:

### Monday P. M., March 19

- Information Theory
- A Storage Tube as an Amplitude Distribution Analyser, by R. E. Nienburg and T. F. Rogers.
- Cross-Correlation and the Optimum Signal-to-Noise Ratio for Periodic Systems, by M. Leifer and N. Marchand.
- Detection of Repetitive Signals in Noise by Correlation, by Y. W. Lee and L. G. Kraft.
- Error Reduction in the Determination of Electronic System Parameters, by L. S. Schwarz.
- Coding Processes for Bandwidth Reduc-

# The MOST VERSATILE AND SENSITIVE Oscilloscope EVER Built!

COMPACT-SIMPLE  
EASY MOBILITY



## Some of the outstanding advantages of the... **NEW LAVOIE LA-239A OSCILLOSCOPE**

- ① Takes the guesswork out of pulse techniques.
- ② Accurately measures amplitude, width, separation, repetition rate and rise time without the need of additional equipment.
- ③ Accurate timing markers provide means of calibrating the linear time base.
- ④ Internal trigger generator permits pulse generator and oscilloscope to be triggered simultaneously, while sweep delay circuit allows a small portion of image to be expanded TEN TIMES normal size.

INCREASED PRODUCTION NOW PERMITS A **REDUCTION** OVER FORMER LIST PRICE WITH SPECIAL REDUCTIONS TO TECHNICAL SCHOOLS AND NON-PROFIT ORGANIZATIONS

Write for Technical Bulletin LA-239A giving complete detailed information.



*Lavoie Laboratories*

RADIO ENGINEERS AND MANUFACTURERS  
MORGANVILLE, N. J.

**Specialists in the Development and Manufacture of UHF Equipment**

VISIT US AT BOOTHS 87, 88 RADIO ENGINEERING SHOW



tion in Picture Transmission, by A. E. Laemmel.

#### Television I—Color

Colorimetry in Color, by F. J. Bingley.  
Subjective Sharpness of Additive Color, by M. W. Baldwin.

Color Multiplexing by Sine Wave Functions, by N. Marchand.

Measurement and Control of Color Characteristics of Flying Spot Color Signal Generator, by R. Moore, J. Fisher and J. Chatten.

Performance of Carrier Synchronizing Circuits for Color Television Receivers, by E. M. Creamer, Jr., and M. I. Burgett.

A Simple Pattern Generator for Color Television Signals, by R. P. Burr, W. R. Stone and R. O. Noyer.

#### Antennas

The Design and Use of the Automatic Antenna Pattern Recorder, by J. W. Tiley.

Stagger-Tuned Loop Antennas for Wide-Band Low-Frequency Reception, by D. K. Cheng and R. A. Galbraith.

A Theory of the Concentric-Slot Antenna, by T. Morita.

Optimum Current Distributions for Antenna Arrays with Circular Symmetry, by R. H. Du Hamel.

Directional Antenna Arrays of Elements Circularly Disposed About a Cylindrical Reflector, by R. F. Harrington and W. R. LePage.

#### Power Tubes I—Theory

Class-C Amplifier Calculations, by D. W. Cawood.

The Effect of Secondary Emission in Power Tubes, by H. Hsu.

Reflex Resonator Operation and its Implication for Bandwidth, by M. Garbuny and G. E. Sheppard.

The Multi-Beam Electron Coupler—An Improved Spiral Beam Electron Tube for the Modulation and Control of Power at UHF, by C. L. Cuccia.

A New Single Cavity Resonator for a Multi-Anode Magnetron, by J. S. Needle, G. Hok, G. R. Brewer and H. W. Welch.

#### Frequency Control and Generation

The Generation of Single-Sideband Suppressed-Carrier Signals by a New Balancing Method, by H. M. Swarm.

Precision Frequency Generators Using Single-Sideband Suppressed-Carrier Modulators, by H. R. Holloway and H. C. Harris.

Stabilized Variable Frequency Transmitter Exciter for Military HF Equipment, by J. Bush.

Wide-Range Direct-Reading Precision Frequency Meter and Signal Source, by B. Parzen.

Crystal Control of a Four-Kilowatt 1.036-Megacycle Transmitter, by J. W. Clark, R. W. Kane and W. G. Abraham.

A Frequency Stabilization System for the Measurement of Microwave Refraction of Gases, by W. F. Gabriel.

#### Communication Systems

AM-FM Analogy, by H. C. Harris.  
Survey of Electronic Commutation Methods, by R. S. Butts.

High-Frequency Radio Communication System Utilizing Phase Modulator Transmission and Single-Sideband Reception, by H. F. Meyer and H. Y. Littlefield.

Echo Distortion in the FM Transmission of Frequency Division Multiplex, by W. J. Albersheim and J. P. Schafer.

Management Aspects of Electronic Systems Engineering, by R. I. Cole.

#### Tuesday A. M., March 20

Symposium: Amplification of DC Signals  
Symposium: Panel Discussion on Tube Reliability

##### Power Tubes II—Development

A Coaxial Power Triode for 50 KW Output up to 110 Mc. by R. H. Rheame.

A High-Power Tetrode, by C. E. Murdock.

The Reflex Resonator, by G. E. Sheppard, M. Garbuny and J. R. Hansen.

Transmitting Tube Suitable for UHF Television, by W. G. Abraham and M. Chodorow.

Frequency-Modulated High-Efficiency Klystron Transmitter, by M. Chodorow and S. P. Fan.

##### Propagation

Selective Fading of Microwaves, by A. B. Crawford and W. C. Jakes, Jr.

Propagation Studies at Microwave Frequencies by Means of Very Short Pulses, by O. E. DeLange.

Low-Frequency Ionospheric Soundings with Atmospherics, by W. J. Kessler and W. F. Zetrouer, II.

The Effect on Propagation of an Elevated Atmospheric Layer of Non-standard Refractive Index, by L. H. Doherty.

Symposium: Broadcast Transmission Systems

## MEETINGS

MARCH 5-9: ASTM Spring Meeting and Committee Week, Cincinnati, Ohio.

MAR. 19-22: IRE Annual Convention, Hotel Waldorf Astoria and Grand Central Palace, New York City.

APR. 16-18: Spring Meeting of the U.S.A. National Committee of the URSI and the Professional Group on Antennas and Wave Propagation of the IRE, at the National Bureau of Standards, Connecticut and Van Ness Sts., N. W., Washington, D. C.

APR. 20-21: Southwestern IRE Conference, Southern Methodist University, Dallas, Texas.

APR. 21: Fifth Annual New England Radio Engineering Meeting, Copley Plaza Hotel, Boston, Mass.

APR. 30-MAY 4: SMPTE Spring Convention, Hotel Statler, N.Y.

MAY 21-23: 1951 Parts Distributors Show, Hotel Stevens,

Chicago, Illinois.

MAY 23-24: Fifth National Convention, American Society for Quality Control, Hotel Cleveland, Cleveland, Ohio.

JUNE 18-22: ASTM Annual Meeting, Atlantic City, N. J.

JUNE 25-29: AIEE Summer General Meeting, Royal York Hotel, Toronto, Ontario, Canada.

AUG. 28-SEPT. 8: Eighteenth British National Radio Show, Earls Court, London, England.

AUG. 29-31: Seventh Annual Pacific Electronic Exhibit and West Coast Annual IRE Convention, San Francisco Civic Auditorium, San Francisco, Calif.

SEPT. 10-14: Sixth National Instrument Conference and Exhibit, sponsored by Instrument Society of America, Sam Houston Coliseum, Houston, Texas.

#### Tuesday P. M., March 20

Symposium: Panel Discussion on Performance of DC Amplifiers

Symposium: Matching Schools and Industry

Circuits I—Synthesis and Analysis  
Network Synthesis Applied to Feedback Control, by J. G. Truxal.

Network Synthesis by Use of Potential Analogues, by R. E. Scott.

Transfer Ratio Synthesis by RC Networks, by J. T. Fleck and P. F. Ordung.

Electrical-Mechanical Equivalent Network Synthesis, by A. E. Gerlach.

Linear Network Neighborhood Equivalence, by D. R. Crosby.

Constant-Resistance Varying-Parameter Networks, by L. A. Zadeh.

Electron Tubes I—Tubes Employing Electron Beams

The Rotating Beam Method for Investigating Electron Lenses, by D. E. George and M. Cooperstein.

The Design of 90-Degree Deflection Picture Tubes, by H. Grossbohlin.

A Miniature Traveling-Wave Tube for the Lower UHF Band, by R. Adler.

Beam Analyzer, by L. R. Bloom, D. F. Holshouser, H. S. Wu and W. W. Cannon.

Generation of Sidebands Due to Gain and Phase-Shift Modulations in a Traveling-Wave-Tube Amplifier, by M. Arditi.

A. G. Clavier and P. Parzen.

Microwaves I—Waveguides A

Development of Waveguide Switches for Commercial and Military Applications, by T. N. Anderson.

Low-Loss Waveguide Transmission, by S. E. Miller and A. C. Beck.

Dominant Wave Transmission Characteristics of Oversize Round Waveguides, by A. P. King.

Radial Probe Measurements of Mode Conversion in Large Round Waveguide with TE<sub>01</sub> Mode Excitation, by M. Aronoff.

A Broad-band Microwave Quarter-Wave Plate, by A. J. Simmons.

Symposium: Panel Discussion on the "Empire State Story"

#### Tuesday P. M., March 20

Symposium: Color Television

#### Wednesday A. M., March 21

Symposium: Industrial Instrumentation  
Computers I—Digital Computers

The Raytheon Selection Matrix for Computer and Switching Applications, by K. M. Weiss.

Saturable Reactors as Substitutes for

Electron Tubes in High-Speed Digital Computers, by J. G. Miles.

Ferromagnetic Cores for Three-Dimensional Digital Storage Arrays, by W. N. Pappan.

A Dependable Small-Scale Digital Computer, by J. Connolly.

An Asynchronous Control for a Digital Computer, by D. H. Gridley.

Circuits II—Filters

Time Domain Filters, by J. Snyder.

Pulse Repetition Filters, by D. L. Waidelich.

Optimum Nonlinear Filters, by H. E. Singleton.

Nonlinear Sampling Filters, by W. D. White.

Statistical Filter Theory for Feedback Systems Subject to Saturation, by G. C. Newton, Jr.

Electronic Filter, by H. C. Sterling.

Electron Tubes II—Special Tubes and Techniques

The Plasmatron, a Continuously Controllable Gas Tube, by E. O. Johnson and W. M. Webster.

Switching Time Limitations in Hydrogen Thyratrons, by J. B. Woodford, Jr.

A New Type Heater Cathode Tube for Portable Battery-Operated Equipment, by G. W. Baker.

New Vacuum-Tube Materials, by E. B. Fehr and A. P. Haase.

Properties of Interfaces in Metal-to-Ceramic Seals, by W. H. Christoffers and R. P. Welling.

Microwaves II—Waveguides B

The Precision Measurement of the Equivalent Circuit Parameters of Dissipative Microwave Structures, by A. A. Oliner and K. Kurss.

On the Excitation of Surface Waves, by G. Goubau.

Interaction Between Surface Wave Transmission Lines, by A. A. Meyerhoff.

Multi-Element Directional Couplers, by S. E. Miller and W. W. Mumford.

The Effect of Radiation on the Q of Resonant Sections, by R. A. Chipman, E. F. Carr, and N. A. Hoy.

Symposium: Some Systems Problems of Air Traffic Control

#### Wednesday P. M., March 21

Electronic Instrumentation

Microwave Methods in Gas Analysis, by J. Weber.

X-Ray Liquid Level Gage, by J. E. Jacobs and R. F. Wilson.

Noise Figure Standards, by M. Solow.

(Continued on p 297)



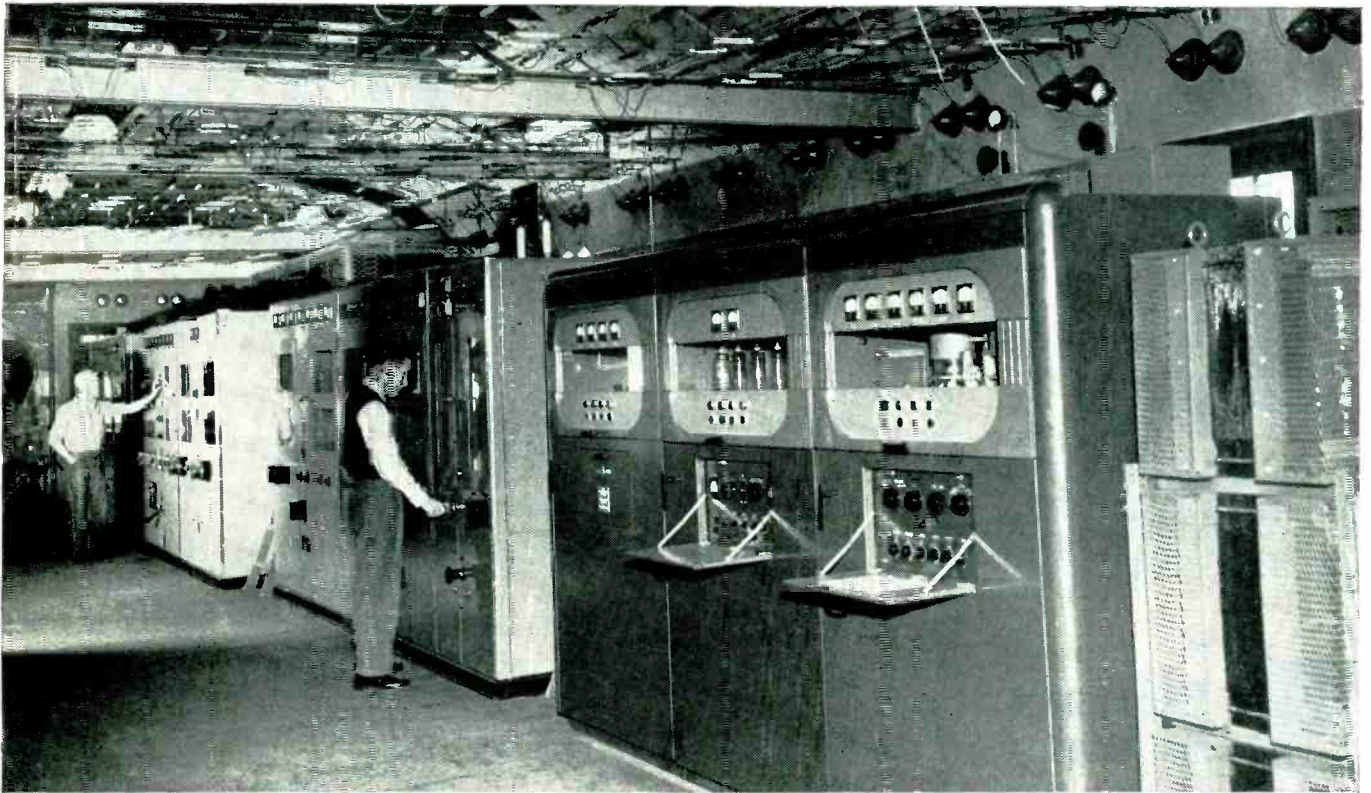

An aisle at the giant Press Wireless transmitting station at Hicksville, Long Island, N. Y., showing 3 of the 35 transmitters (from 2.5 to 50 kw output), in constant use. These transmitters beam news to North America, Central America, and South America,

Europe, Africa, the Middle East, and to Iron Curtain countries, including the U.S.S.R., through the Voice of America and United Nations broadcasts. All the transmitters are keyed and controlled with equipment using Sylvania Radio Tubes.

# SYLVANIA RADIO TUBES HELP PRESS WIRELESS CARRY THE NEWS TO ALL THE WORLD!

Voice of America broadcasts to Russia and the Iron Curtain countries . . . United Nations broadcasts to the world . . . news stories and pictures for the world's newspapers, magazines, and radio stations . . . this is the vital 24-hour-a-day task of the far-flung transmitters and receivers of Press Wireless, Inc. Jointly owned by leading newspapers and news services, Press Wireless is handling the biggest job of news transmission the world has ever known!

With such an urgent mission, dependability is the keynote. And naturally, to insure that dependability, Press Wireless uses Sylvania Radio Tubes by the thousands in its equipment. Like expert production and design engineers everywhere, Press Wireless' staff has found by experience that Sylvania precision, uniformity, and reliability add up to quality that can't be beat. For complete characteristics of radio tubes for every application, or for help on your special problems, write Sylvania Electric Products Inc., Dept. R-1103, Emporium, Pa.

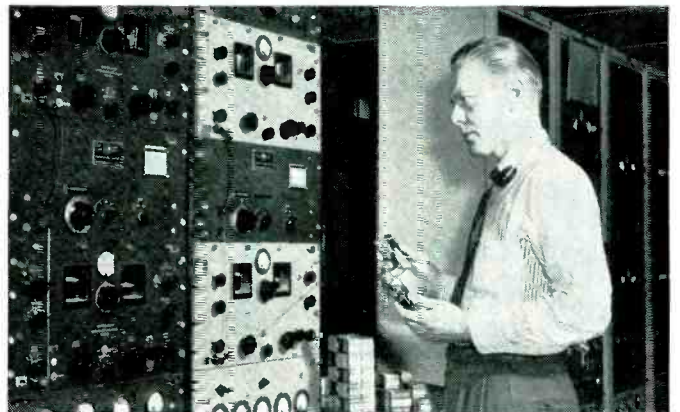

At the Press Wireless Receiving Station at Baldwin, Long Island, N. Y., all 29 receivers use Sylvania Radio Tubes in many applications. Tuned to London, Paris, Rome, Moscow, Madrid, Buenos Aires, Mexico City, and many other news centers, they receive code and voice transmissions as well as teletype, and radio photos for dissemination to all America.



# SYLVANIA ELECTRIC

RADIO TUBES; TELEVISION PICTURE TUBES; ELECTRONIC PRODUCTS; ELECTRONIC TEST EQUIPMENT; FLUORESCENT TUBES, FIXTURES, SIGN TUBING, WIRING DEVICES; LIGHT BULBS; PHOTOLAMPS; TELEVISION SETS



## NEW BOOKS

### TV and Other Receiving Antennas

By ARNOLD B. BAILEY. *John F. Rider Publications, Inc., New York, 1950, 595 pages, \$6.00.*

AN ANTENNA is a wonderful device. It accepts energy from some source of r-f power and, in a manner not too clear to a great many well-trained engineers, creates at a remote point a disturbance which can be translated into a human communication. Some of the answers to the antenna how question will be found in this book.

The periodical literature on antennas, their theory and their design is voluminous but there are not many books on the subject. Those which do exist seem aimed at the erudite reader who is possessed of much mathematical ability. This 600-page volume, therefore, should

#### RELEASED THIS MONTH

Electronics: P. Parker; Longmans, Green and Co., New York; \$10.00.

Introduction to Industrial Electronics: R. Ralph Benedict; Prentice Hall; \$6.35.

Quartz Vibrators and Their Applications: P. Vigoureux and C. F. Booth; His Majesty's Stationery Office, London; \$6.75.

be useful to a broad cross-section of communications engineers. Although the author is speaking mostly about tv antennas, and, therefore, about short-wave radiators, the concepts and illustrations he uses may be employed at other frequencies.

This reviewer does not have the expert knowledge to say whether the author's concepts are rigidly correct or not, but even if not, they are provocative and instructive.

After a review of definitions and terminology, a discussion of the television signal and a discussion of problems of tv reception, the author considers the electromagnetic wave, the radio path, the theory of signal interception, devotes some 85 pages to the center-fed half-wave dipole, discusses parasitic element arrange-



Liberty Hi-Efficiency dichroic mirrors or filters divide the incident light into reflected colored beams and transmitted colored beams. Because these mirrors and filters have almost no light absorption, they permit the use of practically all of the incident light. This low absorption quality is an especially important advantage when using two or more dichroic mirrors or filters to secure more than two beams of light.

The development of these new Liberty Hi-Efficiency dichroic mirrors and filters has made possible the design and production of many new and improved optical and electronic instruments—and has contributed substantially to the betterment of a variety of special optical and electronic apparatus for the defense program. Liberty Hi-Efficiency dichroic mirrors also are used in some types of color television, particularly in industrial color television systems.

Usually these Liberty mirrors and filters are specially produced to satisfy to a maximum degree the specific reflection and transmission qualities required for the specific application. They can be produced to peak in reflection at approximately any part of the spectrum.

Where a photographic record is desired, Liberty Hi-Efficiency dichroic mirrors or filters can be constructed to beam over 90% of the photo active light utilized by the film, and simultaneously beam equally efficiently the residual light rays to another sensing element, such as the eye, a photocell or a photo-relay system. They also are used with cathode ray tubes to separate the phosphor light sources into their several separate peaks.

Liberty Hi-Efficiency dichroic mirrors and filters can be produced with electrical conducting properties in the order of 20 to 40 ohms per square area. This electrical conducting characteristic permits the elimination of static electricity or, alternately, permits the introduction of space charges. Because considerable current can be passed through such electrical conducting dichroic mirrors and filters, they can be heated where required.

Outstanding characteristics of Liberty Hi-Efficiency dichroic mirrors and filters are their extreme durability and the ease with which they may be cleaned. They are highly resistant to corrosion by salt or other corrosive agents. They also are highly resistant to deterioration by solvents—and distinguished for long life in service.

## LIBERTY VACUUM

FIRST SURFACE MIRRORS  
SECOND SURFACE MIRRORS  
NEUTRAL FILTERS

Valuable guides for television technicians

Check the ones that can help you most and see them on approval

1.

### Movies for TV

By *Battison*. All the information you need to choose the best equipment, operate it efficiently and make the most effective use of films on TV. Shows what may go wrong and how to avoid it; how to edit film, produce titles, special effects, commercials, newsreels, combine live scenes with film, and all other techniques. \$4.25

2.

### Television & FM Antenna Guide

By *Noll and Mandl*. Complete data on all VHF and UHF antennas, including information on new types given here for the first time. Shows how to select the right type for the site, where and how to install it, how to minimize noise from transmission line, and all other techniques needed to insure getting the most out of any antenna system. \$5.50

3.

### Television for Radiomen

By *Noll*. Clear, non-mathematical explanation of the operating principles and function of every part and circuit in today's TV receivers and the basic principles of transmission. Full instruction in installation, alignment, testing, adjustment, trouble-shooting. \$7.00

4.

### Radio and Television Mathematics

By *Fischer*. 721 sample problems and solutions show you what formulas to use, what numerical values to substitute, and each step in working out any problem you may encounter in radio, television or industrial electronics. Conveniently arranged for quick reference. \$6.00

#### USE THIS COUPON

The Macmillan Co., 60 Fifth Ave., New York 11

Please send me the books checked by number below. I will either remit in full or return the books in 10 days.

1. 2. 3. 4.

Signed .....

Address .....

# HI-EFFICIENCY DICHOIC MIRRORS OR FILTERS?

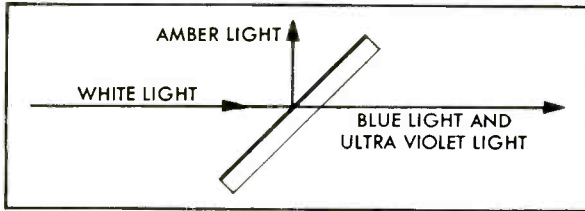

Diagram of typical 45° use of a Liberty Hi-Efficiency dichroic mirror. Such mirrors and filters frequently are used at approximately this angle.

With white light illumination the two separated beams are complementary. With gas discharge tubes or phosphor light sources the two separated beams may be utilized to isolate certain portions of the spectrum of the illumination source.

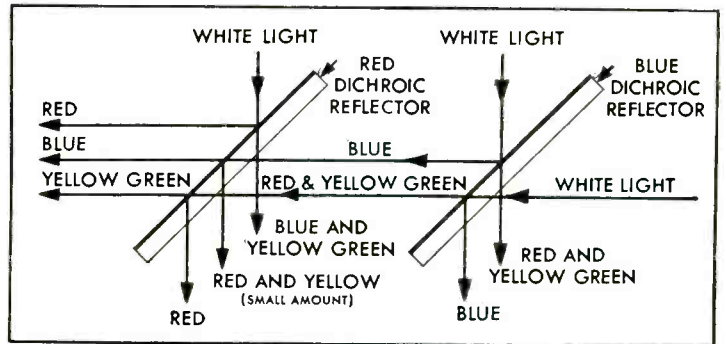

Diagram of typical result obtained by the use of two Liberty Hi-Efficiency dichroic mirrors.

At the left, is the spectrophotometric curve of a Liberty blue-reflecting dichroic mirror recorded at substantially normal incidence. Customer's specification called for peak reflection at 450 millimicrons; our designation for the resultant mirror is 90-450, indicating the approximate reflectivity at the approximate peak.

Comparison of the reflection and transmission curves shows the almost complete absence of light absorption. All Liberty Hi-Efficiency dichroic mirrors and filters possess little or no light absorption.



Liberty Hi-Efficiency dichroic filters possess rather sharp bands. However, these bands are not as sharp as the well-known "interference filters", and are not intended to replace them. Liberty Hi-Efficiency dichroic filters find application where high selective transmission is the determining requirement.

Liberty dichroic filters are made by coating commercial plate glass or optically ground and polished glass, as the use requires. Such construction has apparent advantages for certain applications, as compared with the use of colored glass filters. It completely eliminates the problems arising from defects such as are common in specially made colored glasses, particularly in large sizes. Further, such special colored glasses are not always readily available, and frequently must be made up on special order. In contrast, Liberty Hi-Efficiency dichroic filters are quickly available, with prompt delivery of uniform production lots—and color characteristics are independent of the thickness of the glass support.

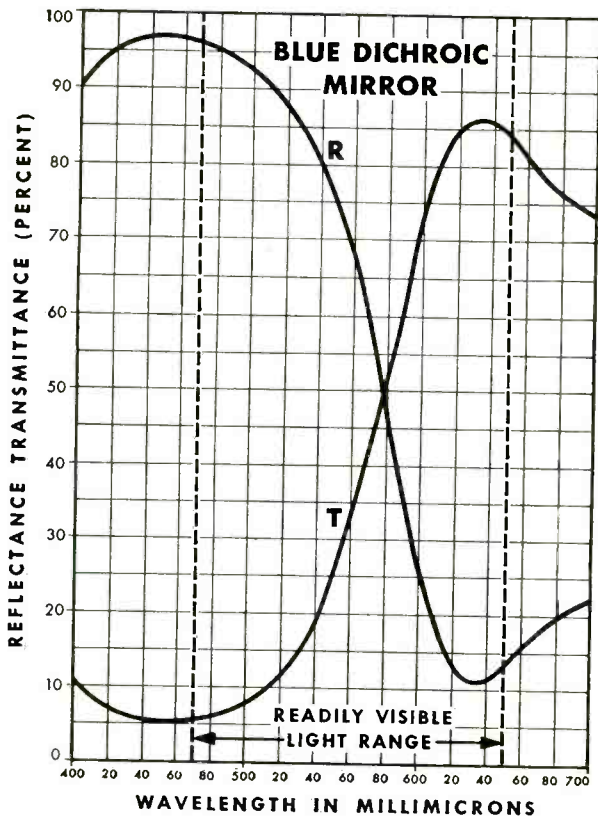

Liberty Hi-Efficiency dichroic mirrors and filters are made in standard production sizes up to 20" x 30"; larger sizes available on special order.

In making inquiry for dichroic mirrors and filters, please specify approximate reflection peak desired, as well as trans-

mission characteristics intended, angle of use and type of light source.

If a phosphor light source is used, please give number or spectral character of the phosphor. Information as to types of sensing elements and their spectral responses also is helpful.

We invite your inquiries on orders of one of a kind — or thousands. Each will receive our early and most experienced attention.

## DEPOSITED COATINGS — LIBERTY MIRROR DIVISION

BEAM SPLITTERS  
ELECTRICAL COATINGS  
LOW REFLECTION COATINGS

LIBBEY • OWENS • FORD GLASS CO.

L 231 NICHOLAS BUILDING • TOLEDO 3, OHIO



# Q E E!

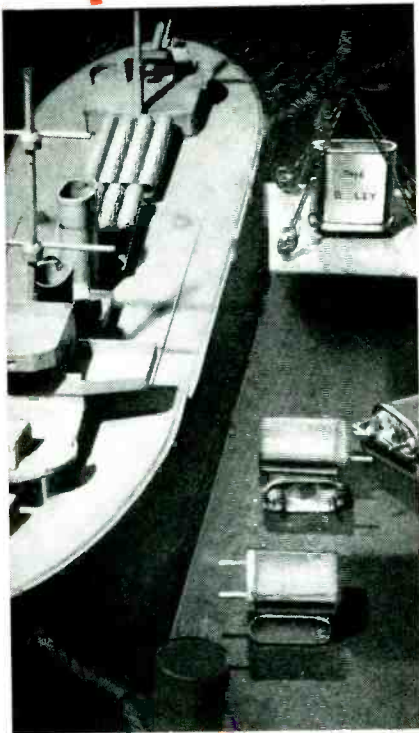

Shown  
Bliley Type  
BH-6

**QUALITY is**

**ESSENTIAL in EMERGENCIES!**

*Emergencies  
demand performance!*

Because of 20 years of engineering skill and proven craftsmanship, Bliley crystals are always "Welcome Aboard" as dependable electronic gear in communications equipment and special electronic devices.

**Bliley  
CRYSTALS**

**BLILEY ELECTRIC COMPANY  
UNION STATION BUILDING  
ERIE, PENNSYLVANIA**

## Backtalk

This department is operated as an open forum where our readers may discuss problems of the electronics industry or comment upon articles which **ELECTRONICS** has published.

### Even More Queasy

DEAR SIRs:

IT SEEMS A SHAME to throw away Bob Wakeman's minus sign, because it makes the quiz even more queasy. I refer to the solution of the November **ELECTRONICS** Quiz problem, which you printed in the December, 1950 issue.

What is the input impedance across the input terminals of a ladder composed of 2-ohm series resistances and 4-ohm shunt resistances, if it is terminated by a negative resistance of  $-2$  ohms? The value of the last shunt resistance in parallel with the negative terminating resistance would therefore be  $-4$  ohms. The last series resistance brings the value back to  $-2$  ohms. Similarly, the  $-2$  ohms is reflected back indefinitely, and  $R = -2$ , no matter how many sections of positive resistance are included.

R. G. MIDDLETON  
Woodside, New York

### Simultaneous Systems

DEAR SIRs:

OUR ATTEMPT to describe the RCA color television system as a dot-multiplex, dot-sequential, or dot-interlace system has apparently caused a great deal of confusion. I was rather perturbed, for example, by the article published in **ELECTRONICS** (R. B. Dome, p 70, Sept. 1950) on the GE system of color television and the editorial comment that this was revival of the simultaneous system, as though the RCA system were not simultaneous. Since sampling multiplies the

**Now Available!**

**MICRODIMENSIONAL  
WIRE**  
*Custom-Enamel*  
to your specifications

The enamel-insulation of our microdimensional wire meets the high standards of quality set by all our products. The enamel is uniform, tough, flexible and has high dielectric strength . . . Send us your specifications or inquire for further details.

**SIGMUND COHN CORP.**  
44 GOLD STREET  
NEW YORK 7, N. Y.

SINCE 1901

To:

**PRIME CONTRACTORS  
and SUBCONTRACTORS  
on GOVERNMENT WORK . .**

*Invitation*  
TO RECEIVE A  
**PRODUCTION  
SAMPLE**  
*Transformer*

BUILT TO YOUR SPECIFICATIONS

*this is our offer to you . . .*

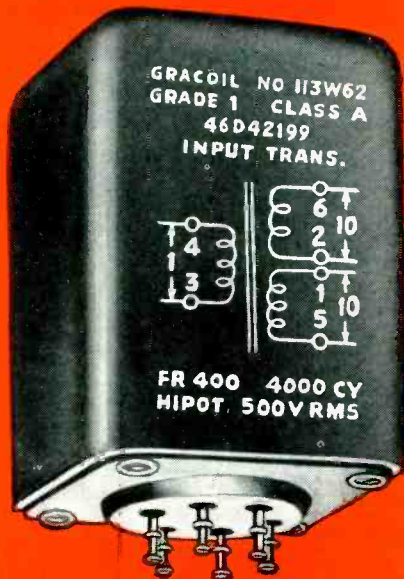

**WE WILL**, without cost or any obligation whatever, design a PRODUCTION SAMPLE transformer (hermetically sealed to JAN-T-27 or MIL-T-27 Government specifications), or open type construction, if unit is to be used for awarded prime or sub-contract work. Our approach stresses quality of product, efficiency in service and an alertness to techniques that discard the old for more functional methods.

*James M. Blackledge*  
PRESIDENT

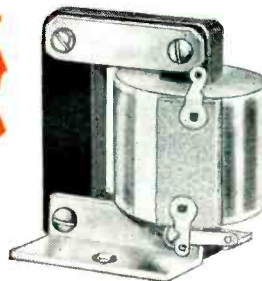

**SEND YOUR  
B/P  
SPECIFICATIONS**

# GRAMER

**TRANSFORMER  
CORPORATION**  
2734 N. PULASKI ROAD • CHICAGO 39, ILLINOIS



# bringing

# Your FASTENERS

# to market

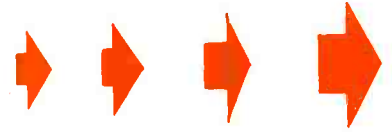

# is a full time job for... electronics

A big tv maker estimates that one billion, eight hundred and sixty-two million (1,862,000,000) fasteners were used in tv set assembly in 1950. That 1,862,000,000 is for fasteners used in the final assembly of tv sets only. It does not include the great quantities of fasteners used in the many tv subassemblies. Nor does it take into account the billions of fasteners used in the more than fourteen million radios produced in 1950 . . . or the fasteners used in the industrial, military, aviation, communication, broadcast, instrument and other fields of electronics. It accounts for only those screws, nuts, washers, rivets, lugs and special fasteners used in the final assembly stage of tv set manufacture. It is just an indication of the proportions the fastener market is attaining in television.

The final assembly stage exemplifies the engineering functions of fasteners in electronics and explains why they are design engineer specified and bought. Television, like many other products, is a mass production item and, wherever it is possible without affecting quality, production shortcuts and economies are designed-in. That is why so many special rivets and self-tapping screws, and so few standard machine screws, nuts and washers are used. It also accounts for the small number of solder lugs used in the average tv set. The metal chassis is designed by the lab with tabs to take the place of the separate solder lugs.

The reasons for designers' fastener specifications are as varied as the fasteners they design-in. The rivets used may be one kind because that kind works better in the riveting machines. The self-tapping screws may be another manufacturer's because he holds to design-specified tolerances. Other special fasteners may be designed-specified because of service or maintenance requirements, simplicity, stability, vibration or other important engineering considerations. The reasons for specific fastener specifications in electronics are varied. The specifiers are always the same — the laboratory design engineers.

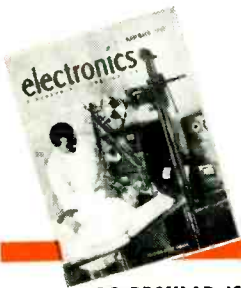

# electronics



**12 REGULAR ISSUES**  
supplying latest technical information, design and product news

A McGraw-Hill Publication • 330 West 42nd St., New York 18, N. Y.

**ANNUAL BUYERS' GUIDE**  
supplying all basic product source and technical specifying data

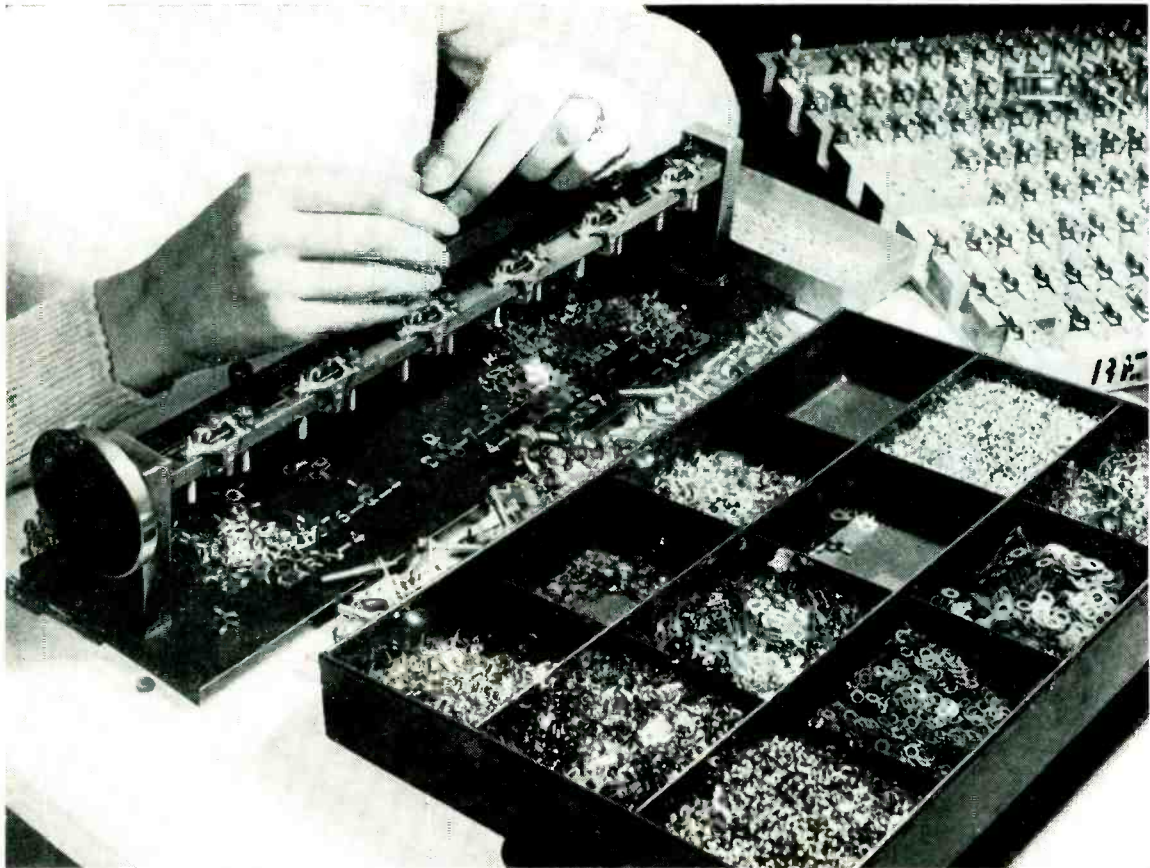

Picture above, like the 1,862,000,000 figure mentioned on the opposite page, is simply an attempt to visualize for you one small portion of the market for fasteners offered by *ELECTRONICS*. This is an assembly line job in which sixteen screws, washers and other special fasteners are installed on a widely used electronic instrument component.

Fasteners like every other component or material used throughout the science-art-industry of electronics are designed-in, specified and bought by engineers. You may feel that fasteners are just "hardware" and as such beneath the attention of the lofty electronists. But, "hardware" or not, and this is important because it is the key to increased fastener sales in electronics, fasteners are important, integral components designed-in, specified and bought by electronic design engineers just as carefully as any other design component.

The design engineers who direct fastener purchasing are subscribers to and readers of *ELECTRONICS*. Its sales pages are for them the chief source . . . sometimes the only one . . . of the information on which they base their specifying-buying. These engineer readers of *ELECTRONICS* constitute your market. They are the men to whom you must bring your product — the men you must reach and influence. That's where *ELECTRONICS* specializes — taking product stories to the important buying factors — and returning sales. That's *ELECTRONICS'* full time job . . . taking products to market. *ELECTRONICS'* subscribers are the men in all the fields of industry who design, specify and buy fasteners. By full use of the sales opportunities in the advertising pages of *ELECTRONICS*, you can take YOUR fasteners or kindred products to market.

---

**THE DIRECT ROUTE TO — — — — — A \$2,000,000,000 MARKET PLACE**



Check

# R-B-M INDUSTRIAL CONTACTORS NOW!

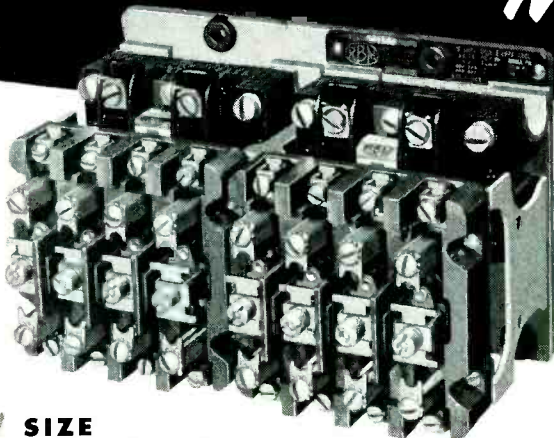

Underwriters' Approved.  
600 Volts AC

## SIZE

### Non-Reversing

2 to 4 Pole 2-3/4" w. x 3-5/8" h. x 3-5/16" d.  
5 to 8 Pole 5-9/16" w. x 3-5/8" h. x 3-5/16" d.

### Reversing

2 to 4 Pole 5-9/16" w. x 3-5/8" h. x 3-5/16" d.

Note: 10 and 15 ampere contactors have same mounting and overall dimensions.

## ACCESSIBILITY

To replace contacts, it is not necessary to disassemble the complete contactor. Just remove the parts comprising the stationary and movable contacts. Contacts can be replaced without disturbing wiring. To change coil, remove magnet frame and coil assembly only. (See illustration below.)

## FLEXIBILITY

Using a screw driver only, you can easily change any pole from normally open to normally closed. No special parts required. 10 and 15 ampere parts are interchangeable.

## RELIABILITY

Laboratory tests involving millions of operations, plus field service of thousands of R-B-M contactors on door operators, radio transmitters, packaging and weighing machinery, hoists, machine tools and many other industrial applications offer proof of dependable, trouble-free performance.

## ADVANCED DESIGN

Melamine Insulation. Molded coil housing. IlSCO solderless connectors. 50/60 cycle magnet coils. Palladium silver contacts. Stainless steel self-contained contact springs.

Where space is a factor, and accessibility a must—use R-B-M industrial contactors. Initial low cost plus dependable performance will save you money. Write for Bulletin 600 and price list on your company letterhead.

Address Dept. F3,

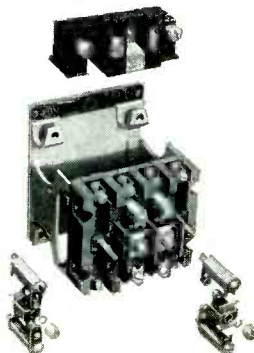

## TUBES AT WORK

(continued from p 138)

difficulties result: the signal received will vary anywhere from essentially nothing, due to cancellation, to about double that for path A alone, due to reinforcement; and the pattern as defined by the field at the test antenna, will be a complex combination of the patterns in two planes, differing in altitude by the angle  $\beta$ . Generally the horizontal pattern is desired, so the two antennas must be on the same level reducing  $H_1$  and  $H_2$  and angles  $\alpha$  and  $\beta$  to the same value.

It is obvious that the only remedy for the interference is to reduce the radiation along path B to a satisfactory minimum. This may be accomplished in two ways. First, the antenna heights are made as large as possible compared to the separation D. This will reduce the field from path B inversely in proportion. Distance D is usually fixed by the frequency of operation and the size of the antennas by a commonly accepted relationship  $D = Kd^2/\lambda$  where K is a value of unity, or greater (depending on the degree of pattern accuracy desired), d is the aperture of the antennas and  $\lambda$  is the wavelength of operation. Hence the height above ground is no longer a matter of simple arbitrary choice. Secondly, the radiation from the source antenna may be made directive in the vertical plane so that there is relatively little radiation at the angle  $\alpha$ .

### Testing Large Antennas

Testing of large antennas at low frequencies will be found to require large distances D and consequently large heights above ground. The cover page illustrates a tower structure designed to meet the requirements of these conditions. The tower structure is mounted on skids and is moved about to suit different distances D by means of a bulldozer. The source antenna is mounted on a sliding frame, which may be elevated to the desired height after the antenna has been constructed and attached to the frame at ground level.

The condition of vertical directivity is demonstrated also. The source antenna consists of two vertical rows of folded dipole antennas, four in each row, fed in phase and so spaced as to give the



**R-B-M DIVISION**  
**ESSEX WIRE CORP.**  
Logansport, Indiana

MANUAL AND MAGNETIC ELECTRIC CONTROLS  
— FOR AUTOMOTIVE, INDUSTRIAL, COMMUNICATION AND ELECTRONIC USE

Only *A SMALL PIECE OF*  
*the pie...*

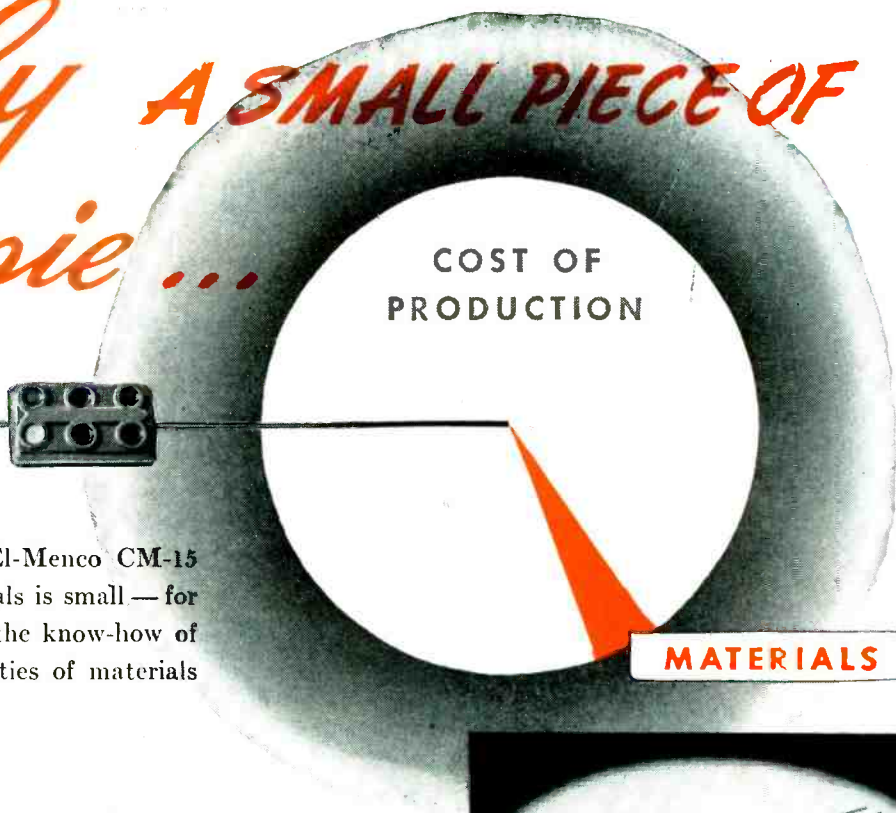

In the price of the El-Menco CM-15 capacitor, the cost of materials is small — for few materials are used. It's the know-how of putting these minute quantities of materials together that really counts.

Tiny as it is, the El-Menco CM-15 high-capacity fixed mica condenser exceeds the strict requirements of the Army and Navy. It is tested for dielectric strength at double its working voltage *before* leaving the factory — insulation resistance and capacity value. You can depend on this mighty midget — even under the most critical operating conditions and climate extremes.

**ALWAYS SPECIFY  
 EL-MENCO CAPACITORS**

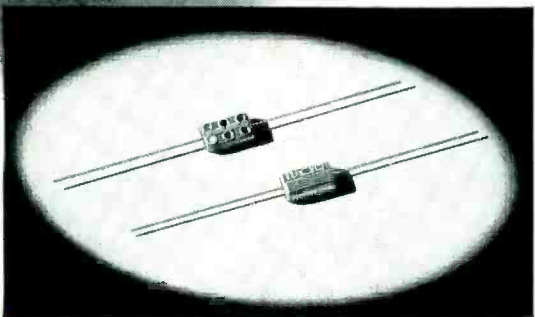

**CM-15 MINIATURE CAPACITOR**

Actual Size 9/32" x 1/2" x 3/16"  
 For Television, Radio and other Electronic Applications.  
 2 mmf. to 420 mmf. cap. at 500v DCw.  
 2 mmf. to 525 mmf. cap. at 300v DCw.  
 Temp. Co-efficient ± 50 parts per million per degree C for most capacity values.  
 6-dot color coded.

**THE ELECTRO MOTIVE MFG. CO., Inc.**  
 WILLIMANTIC CONNECTICUT

Write on your firm letterhead for  
 Catalog and Samples.



**MOLDED MICA** **El-Menco** **MICA TRIMMER**  
**CAPACITORS**

FOREIGN RADIO AND ELECTRONIC MANUFACTURERS COMMUNICATE DIRECT WITH OUR EXPORT DEPT. AT WILLIMANTIC, CONN. FOR INFORMATION.  
**ARCO ELECTRONICS, INC.** 103 Lafayette St., New York, N. Y.—Sole Agent for Jobbers and Distributors in U.S. and Canada



# NEW Miniature Telephone Type Relay

## NEW LK RELAY

**MOUNTING:** End mounting for back of panel or under-chassis wiring. Interchangeable with standard "Strowger" type mounting.

**COIL POWER:** From 40 milliwatts to 7 watts D.C.

**CONTACTS:** Standard 2 amperes, special up to 5 amperes. 2 amperes up to 6 P.D.T. 5 ampere contacts (low voltage) up to 4 P.D.T. Special 20 ampere power contacts S.P.S.T., normally open, paralleled.

### DIMENSIONS:

1 $\frac{5}{8}$ " HIGH, 2 $\frac{7}{32}$ " LONG,  
1 $\frac{3}{32}$ " WIDE

*These are the dimensions  
for the 6 pole relay.*

*Will meet Army and Navy  
aircraft specifications  
as a component unit.*

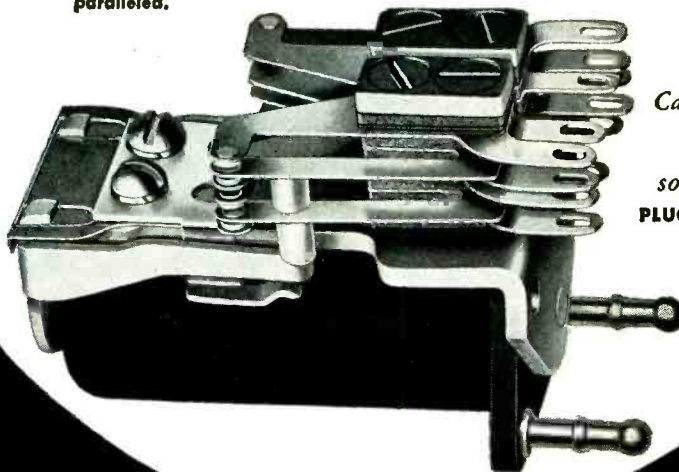

*Can be furnished  
hermetically  
sealed with  
solder terminals.*

**PLUG-IN MOUNTING-SPECIAL.**

## SK RELAY

**MOUNTING:** Front of panel mounting and wiring.

**COIL POWER:** From 100 milliwatts to 4.5 watts D.C.

**CONTACTS:** Same as "LK".

**DIMENSIONS:** 1 $\frac{1}{2}$ " HIGH, 1 $\frac{1}{16}$ " LONG, 3 $\frac{1}{32}$ " WIDE.

*These are the dimensions  
for the 4 pole relay.*

*Will meet Army and Navy  
aircraft specifications  
as a component unit.*

**CAN ALSO BE FURNISHED  
HERMETICALLY SEALED  
WITH SOLDER TERMINALS.  
PLUG-IN—SPECIAL.**

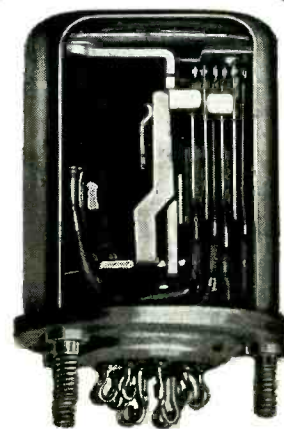

SK, HERMETICALLY SEALED



**ALLIED CONTROL CO. INC.** 2 EAST END AVE., NEW YORK 21, N. Y.

AL-132

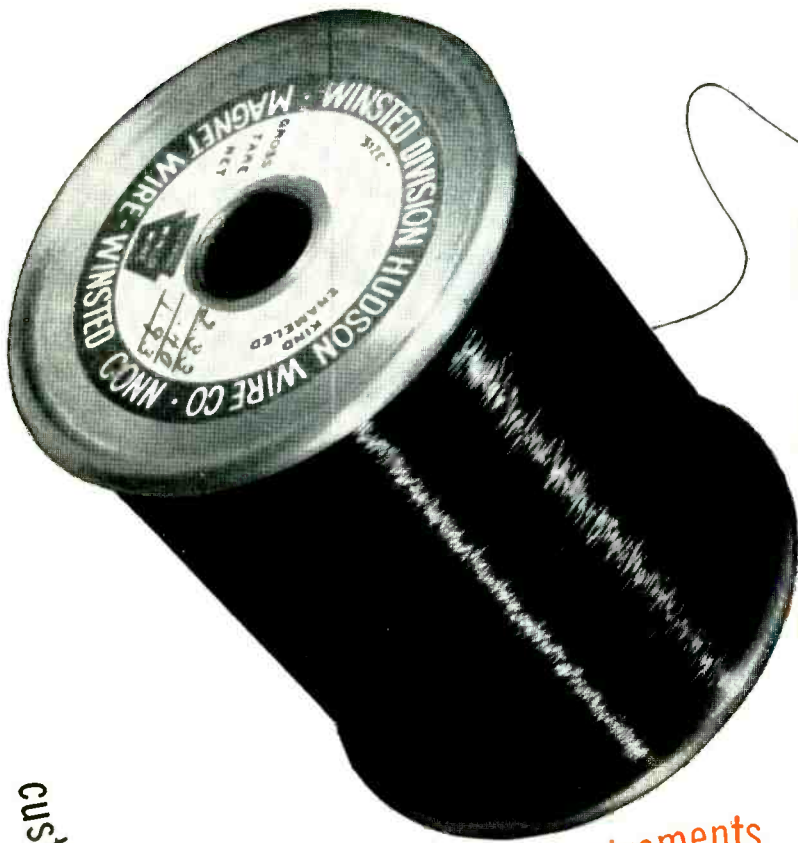

# FINE WIRE made finer

⊙ Custom-made fine wire! Just specify the electrical properties, flexibility, tensile strength, laying speed, uniformity and other characteristics you must have. Our Hudson and Winsted Divisions will meet and maintain your specifications.

Uniformity of product is guaranteed by our critical supervision which guards against variations in size, structure and electrical values. Yes, "Fine Wire Made Finer!" That is why Hudson-Winsted fine wires are the first choice of electrical, radio, television and electronic manufacturers whose products are noted for reliability and long life.

custom drawn ⊙ custom insulated ⊙ requirements to your most exacting ⊙ custom spooled

⊙ Tell us your wire problems and requirements. Our research, engineering and production facilities are at your disposal. Let us quote!

#### BARE WIRES (HUDSON WIRE DIVISION)

Copper	Silver-plated
Brass	Brass
Zinc	Phosphor-Bronze
Tinsel	Silver
Tin	Monel
Nickel-Silver	Lead Wire
Cadmium	Fuse Wire
Oxygen-free	Specialty
Copper	Wires

#### TEXTILE-COVERED WIRES (WINSTED DIVISION)

Nylon	Cotton
Celanese	Rayon
Silk	Fiberglass

All available on bare or enameled wire, single or double covered.

#### INSULATED WIRES (WINSTED DIVISION)

MATERIALS	TYPES	COVERINGS
Copper	Instrument	Plain and Heavy
Aluminum	Tubing	Enamel
Iron	Litz	Formvar
Copper-clad	Multiplied	EZsol (Liquid
Steel	and Twisted	Nylon)
		Cement-coated
		Enamel

#### FINE WIRES (HUDSON & WINSTED DIVISIONS)

Specializing in fine wires, custom-drawn and insulated, to critical needs—size, material, insulation. Your consideration is called particularly to the finest wire sizes—Nos. 44 to 50.

# HUDSON WIRE COMPANY



general offices: ossining, n. y.    winsted division: winsted, conn.



# PREPAREDNESS PRODUCTION

## Enlists

### AMPHENOL

## Vital to the Job of Defense

### LEADS THE FIELD

Amphenol radio and electronic components — AM and RF connectors, plugs, sockets, cables — reflect the cooperative effort that exists between Amphenol engineers and both civilian and government engineers . . . an effort that develops many new *plus* features over and above specifications and keeps Amphenol ahead of the field!

### NEW — RF CONNECTORS

New to Amphenol's UHF series are 2 cable-to-connector fittings and one right angle adaptor with a lower than usual V.S.W.R. A new "HN" angle plug is approximately 40% lighter than the usual adaptor-plug combination. Five new connectors feature Teflon insulation for low dielectric loss and operation up to 500° F. Also new are 4 pressurized panel receptables and modified "N" plugs, jacks, panel jacks and bulkhead panel jacks.

TUBES AT WORK

(continued)

desired horizontal and vertical radiation patterns. No attempt is made to suppress the backward radiation from this antenna, such a procedure being required only when the general space in that direction has possible reflecting surfaces or when a stronger forward field is needed. In the particular setup shown, the antenna separation was 92 feet and the height above ground 28 feet. Measurements were being made in the frequency range 152 to 162 mc.

### Graphic Recorders With Fixed Styli

BY R. S. BARK

*Electronics Engineer  
School of Medicine  
University of Washington  
Seattle, Washington*

MANY FAULTS of moving element recorders such as fragility, instability and irremediable wear could be avoided if the tracing could be made without moving the marking device. If a stationary stylus were placed along the *y* axis of the chart paper and the marking function were moved along its length in accordance with the value being measured, the basic problem of avoiding moving styli would be solved.

One method might be to terminate the bar as a mismatched transmission line and to electronically control a standing wave, electrical or mechanical, along the bar so as to mark the chart paper, thus indicating the quantity being measured.

A simple method is to divide the length of the bar into discrete segments, each responding to a particular value of the quantity being measured. Recording of mechanical motion may be accomplished by a

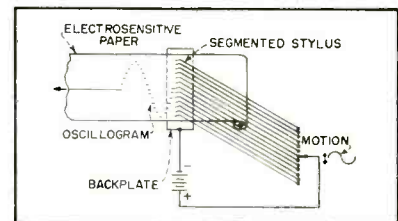

FIG. 1—Simple position-to-position fixed-stylus recorder

March, 1951 — ELECTRONICS



### AMPHENOL

AMERICAN PHENOLIC CORPORATION · 1830 So. 54TH AVE., CHICAGO 50, ILLINOIS

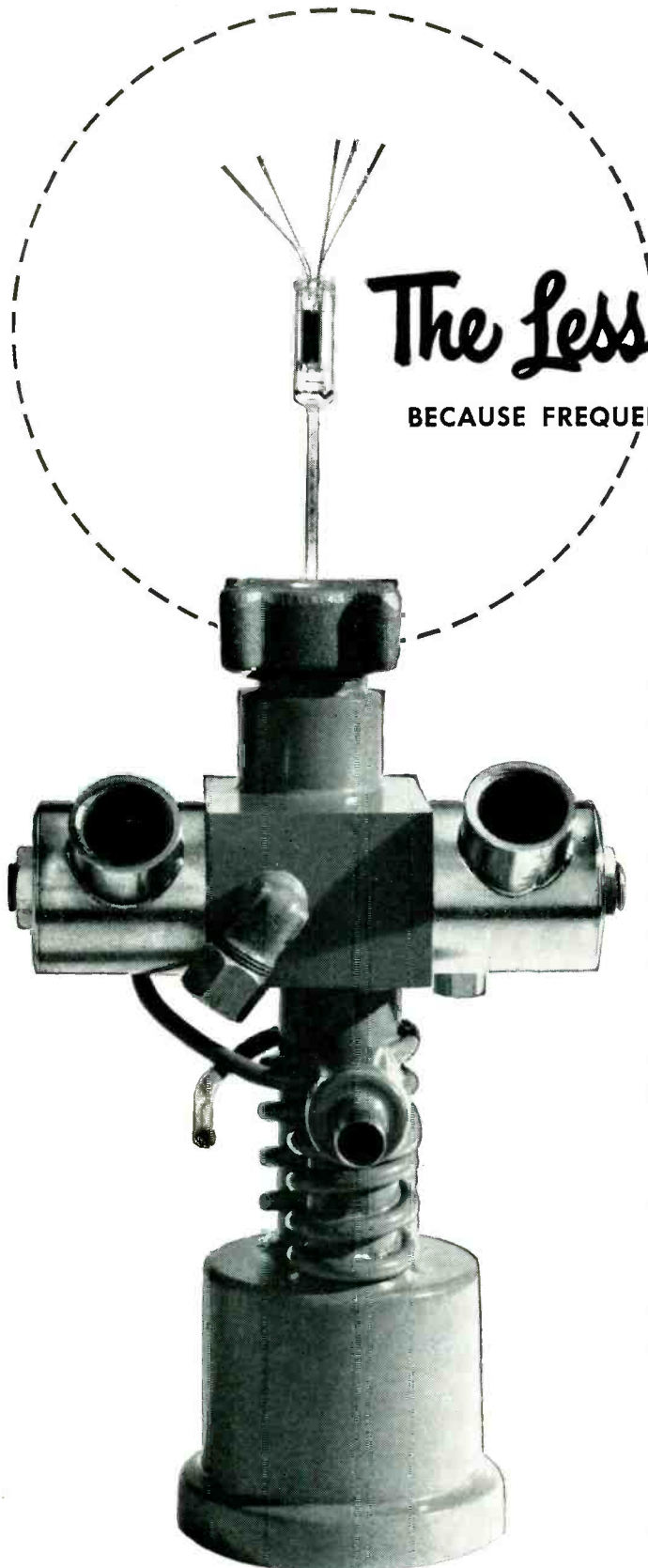

# The Less Getter the Better

BECAUSE FREQUENCIES ARE HIGHER AND TUBES ARE SMALLER

**I**F you manufacture small electronic tubes, DPi's new VMF-5 Exhaust Unit pictured here can provide a happy ending to your quest for lower, more consistent residual gas pressure.

With today's push toward ever-higher frequencies, you can't afford to ignore the effect of residual gas on the low capacitance demanded in tubes: And with the small size of today's tubes, you can't use much getter to "clean up" residual gas, because the metallic film deposited can result in serious inter-element leakage.

VMF-5 Exhaust Units quickly take pressure down to 0.1 micron Hg before the getter flash, as compared with the 10- to 100-micron pressures to which older equipment limits you. They come equipped with water-cooled ports that fit any standard tubulation or can be fitted with ports of your own design. Two a-c solenoid valves (or three if required by the design of your rotary exhaust machine) isolate the diffusion pump during roughing.

The VMF-5 is just one of a series of high vacuum pumps designed by DPi for the specific conditions of the electronics industry. They are made in a wide range of pumping speeds.

Before you go ahead with the design and production of a tube exhaust system, call on DPi. There's no obligation, of course, and chances are that DPi can help build better reliability into your product at less cost. Write: Vacuum Equipment Department, *Distillation Products Industries*, 727 Ridge Road West, Rochester 3, N. Y. (Division of Eastman Kodak Company)

high vacuum research  
and engineering

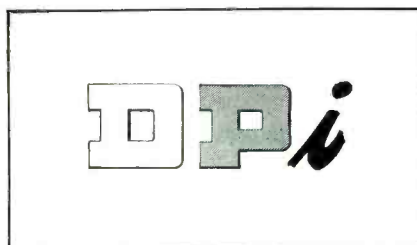

Also . . . vitamins A and E . . . distilled monoglycerides . . . more than 3300 Eastman Organic Chemicals for science and industry.



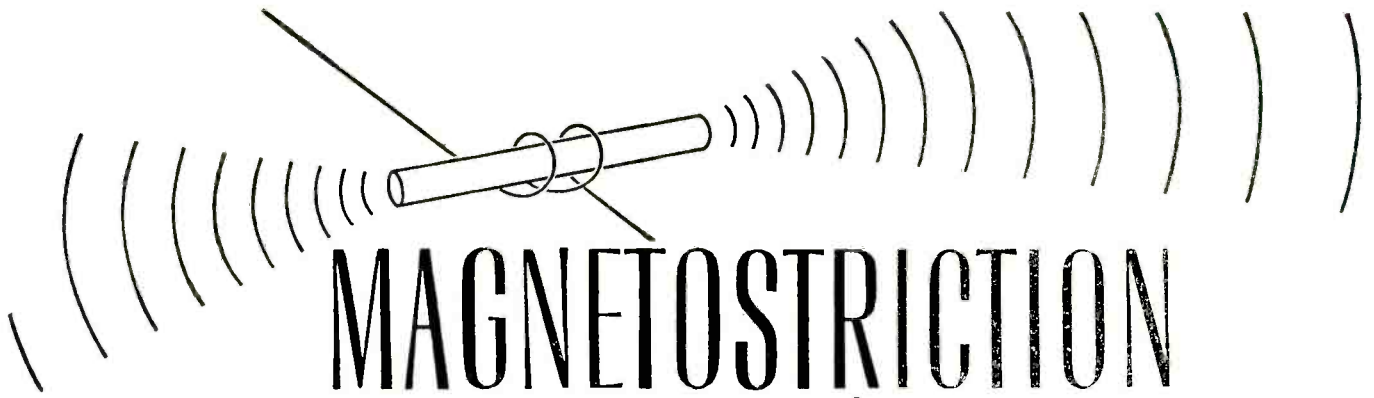

**Once a laboratory curiosity... now serving science  
in surprising ways... with the help of**

**NICKEL**

Like Hertzian waves, Roentgen rays, and radioactivity . . . magnetostriction was once just a physicist's plaything.

Early experimenters noted with interest the unusual behavior of magnetized ferromagnetic materials . . . the "spontaneous" dimensional changes; and inversely, the permeability changes when dimensions were forcibly altered.

But as magnetostriction developed from laboratory demonstration to practical application, it was discovered that few materials offered sufficiently high magnetostrictive response. When the essentials of economy, workability, and availability were considered, the number of suitable materials was still more limited.

• • •

Both research and practice have now established Nickel as a satisfactory solution to this problem. Nickel's magnetostrictive contraction of approxi-

mately thirty parts per million is exceeded only by a few special alloys.

Nickel offers, in addition, excellent corrosion resistance, good resistance to the destructive effects of extreme temperatures, plus strength and hardness equal or superior to that of low-carbon steel. For special applications, even greater hardness can be obtained in Permanickel\* through heat treatment, with only a small loss in mechano-magnetic characteristics.

Nickel is in short supply but if you are interested in magnetostrictive oscillators . . . either for manufacture or application . . . INCO's Technical Service Department will gladly put at your disposal data accumulated from both research and practice.

For your reference files, write for: "Magnetostriction", and "66 Practical Ideas for Metal Problems in Electrical Products."

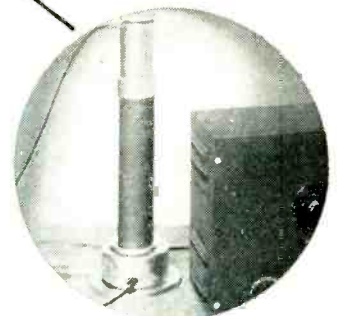

Bacteria Killer. A 9 Kc magnetostrictive oscillator used for sterilization in the chemical and pharmaceutical industries. The magnetostrictive material is laminated Nickel. Made by Raytheon Manufacturing Co., Waltham, Mass.

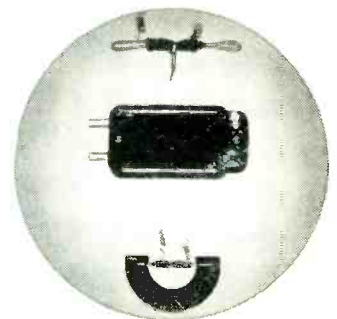

Phonograph Pick-Up: The magnetostrictive unit in this device is a 20-mil Nickel wire which is stretched between the poles of a horseshoe magnet. Variations in torsion caused by deflections of the needle produce flux variations in two pick-up coils that are wound around the stretched Nickel wire.

#### A FEW OF MANY APPLICATIONS FOR MAGNETOSTRICTIVE EQUIPMENT

- "Sonar" and related devices for detecting submarines and ships.
- Raytheon's "Fathometer", for determining depth of waters; locating schools of fish.
- Electrical filters, such as band pass filters for radio receiving sets.
- Homogenization and sterilization of milk.
- Acceleration of chemical reactions and cavitation effects.
- Strain gages.
- Vibration and engine detonation.
- Phonograph pick-ups.
- Frequency control of oscillators operating below 100 Kc.
- Dust and smoke precipitation.

**Coming to the I.R.E. Show?  
Grand Central Palace, N. Y., March 19-22  
Visit us in Booth 35**

EMBLEM OF SERVICE

**NICKEL  ALLOYS**

Monel\* • "R"\* Monel • "K"\* Monel • "KR"\* Monel • "S"\* Monel  
Nickel • Low Carbon Nickel • Duranickel\*  
Inconel\* • Inconel "X"\*

**THE INTERNATIONAL NICKEL COMPANY, INC.**

67 Wall Street, New York 5, N. Y.

\*Reg. U. S. Pat. Off.

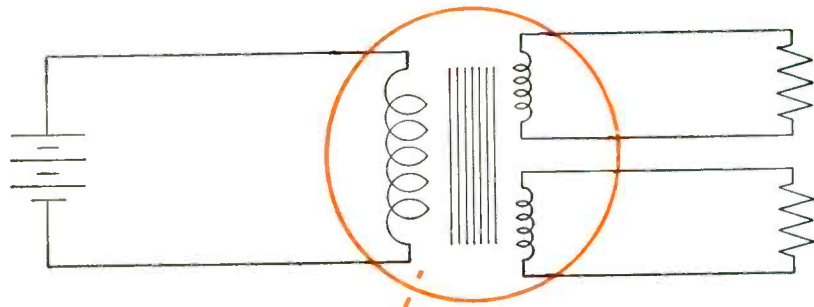

# a DC transformer?

*Certainly...*

## **Bendix Specialized Dynamotors** are made for the Job!



Whenever DC power is required at other than the supply voltage, Bendix\* Specialized Dynamotors function as DC transformers. They can be wound for any input or output voltage between 5 and 1200 volts, and they can deliver power up to 500 watts. Multiple outputs can be supplied to correspond with several secondaries on transformers, and their output voltages can be regulated within close limits regardless of input voltage or load variations. Bendix Specialized Dynamotors are tailored to the exact requirements of each application by the design of the windings used in standardized frames. This reduces the cost, size and weight to an absolute minimum, consistent with the operational requirements. Compliance with Government specifications is assured by the choice and treatment of materials and the basic design. *A complete description of your requirements will enable our engineers to make concrete recommendations . . . All orders are filled promptly and at moderate cost.*

\*REG. U. S. PAT. OFF.

**RED BANK DIVISION OF  
BENDIX AVIATION CORPORATION**  
RED BANK, NEW JERSEY

Expert Sales: Bendix International Division, 72 Fifth Avenue, N. Y. 11, N. Y.

*Write for this colorful and informative book  
—it's free. You'll find it loaded with facts  
and figures about all types of dynamotors.*

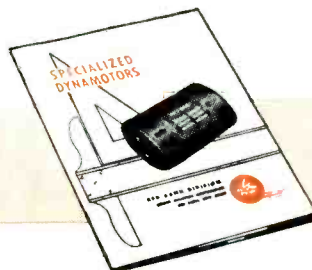





**Resists Violent  
Temperature Changes**

**because all parts are  
MATCHED  
for thermal characteristics**

Switch the temperature back and forth from 340 to  $-55^{\circ}\text{C}$ , over and over, and still you won't affect the stability of Ward Leonard Vitrohm Resistors.

Reason is: Ward Leonard, making all components\*, can control thermal characteristics so as to survive the greatest temperature variations.

Write for Vitrohm Resistor Catalog, Ward Leonard Electric Co., 31 South Street, Mount Vernon, N. Y. Offices in principal cities of U. S. and Canada.

\*Vitreous enamel coating and ceramic cores formulated and made by Ward Leonard . . . wire drawn to Ward Leonard's specifications.

**WARD LEONARD  
ELECTRIC COMPANY**

*Result-Engineered Controls Since 1892*

RESISTORS • RHEOSTATS • RELAYS • CONTROL DEVICES



segmented bar stylus excited from a segmented motion-pickup commutator, the two units being connected by a cable containing a number of electric wires appropriate to the number of segments, as shown in Fig. 1.

Accuracy is independent of marking voltage and calibration is permanent. Accuracy is determined by the resolution of the system, which in turn is set by the number of segments involved in the motion. One hundred segments give one percent accuracy. Frequency response is limited only by the inertia of the pickup transducer arm.

If each bar segment is a tuned reed or actuated through a tuned filter, the recorder will plot frequency. Note that it can plot several frequencies simultaneously so that it can be used as a frequency-spectrum analyzer, see Fig. 2.

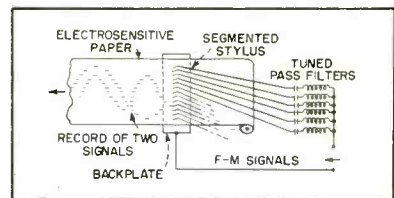

FIG. 2—Frequency-to-position system

External conversion of amplitude to frequency will make the preceding system respond to amplitude. Arrangement of the segments or filters on a logarithmic frequency scale results in a logarithmic recorder of high stability for either frequency or amplitude.

Amplitude, such as voltage, can be translated into position without going through the frequency step just described. A galvanometer may be used, either directly or in a null-balance system, to translate electric current into position by means of an electromechanical commutator. For instance, in a closed-cycle servo (mechanical inverse-feedback) null-balance potentiometer, a commutator on the potentiometer shaft can actuate a segmented bar stylus to electrically mark chart paper, thus eliminating the pen drive and also reducing the total inertia.

The frequency-response limitations of a mechanical commutator may be entirely avoided by an all-

*One Source of Supply - Headquarters for*

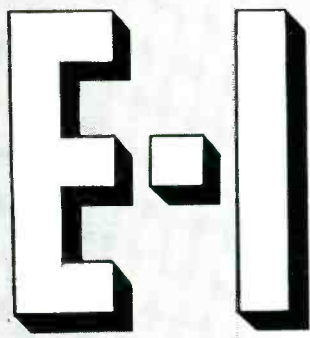

# sealed leads and multiple headers

SEE THEM AT THE I.R.E. SHOW — BOOTH 212

**Standard  
SEALED  
LEADS**

Over 50 standard types to choose from. Made of hard glass, preformed with microscopic air cushioning. Absolutely free from internal strain. Tin dipped for easy soldering. Write for Bulletin 849 for complete information.

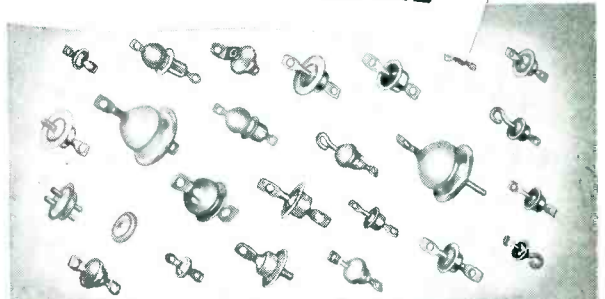

**Standard  
MULTIPLE  
HEADERS**

Over 100 standard types available. All headers vacuum tight, with cushioned glass preforms. Completely strain free, tin dipped, silicone treated. Many optional features including CRT closures. Full information can be obtained by writing for Bulletin 850.



**CUSTOM  
SEALS to  
Specification**

Practically any type of sealed terminal or multiple header can be produced to exact customer requirements. Whether your problem involves a new design or the application of a standard item, E-I engineers offer complete collaboration.

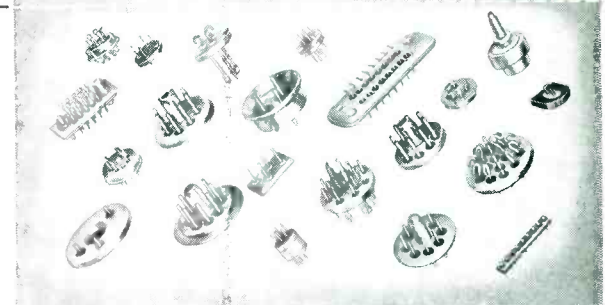

**SAMPLE  
KIT for  
Designers**

Contains 81 standard terminals, 11 different headers. All economy priced items — picked to solve practically any problem. Transparent case with labeled bins for easy selection. Complete kit sells for only \$10.00—check or money order.

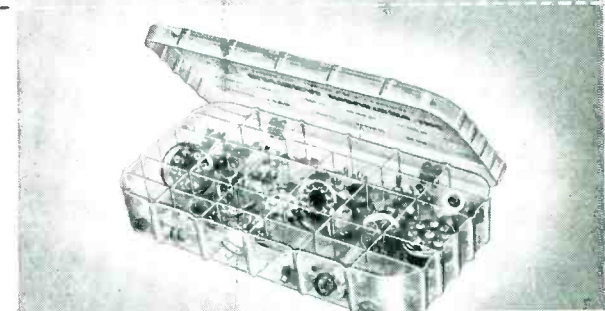

**ELECTRICAL INDUSTRIES, INC**

MANUFACTURERS OF SPECIALIZED ELECTRONIC EQUIPMENT

44 SUMMER AVENUE, NEWARK 4, NEW JERSEY





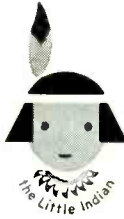

THE LITTLE INDIAN SAYS-

# "Heap good for Signals!"

## SANGAMO TRANSMITTING MICAS



Type G  
(CM 75-80-85-90-95)

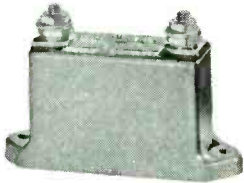

Type F (CM 65-70)



Type H (CM 45-50)



Type A (CM 55-60)

### Built to JAN Specifications

Whether you need a certain characteristic or a combination of several performance features, Sangamo Transmitting Mica Capacitors are "heap good" for your specific capacitor applications. You can safely specify them for use in all types of military, radio and electronic equipment—they are built to meet all standards set by joint Army and Navy Specifications JAN-C-5.

Type G Capacitors are designed for use in medium and high power, high voltage and high current circuits. They are ceramic encased and are fre-

quently connected in gangs to handle heavy loads.

Type F Capacitors are used in similar applications to type G's and are potted in bakelite cases.

Type A and Type H Mica Capacitors are molded in a thermo-setting plastic and are designed for use in low voltage, low power and low current circuits.

Sangamo Transmitting Micas and many other types of Sangamo Mica Capacitors, are fully described in Catalog No. 831. Write for your copy.



Your Assurance of



Dependable Performance

## SANGAMO ELECTRIC COMPANY

SPRINGFIELD, ILLINOIS

IN CANADA: SANGAMO COMPANY LIMITED, LEASIDE, ONTARIO

8C41-2

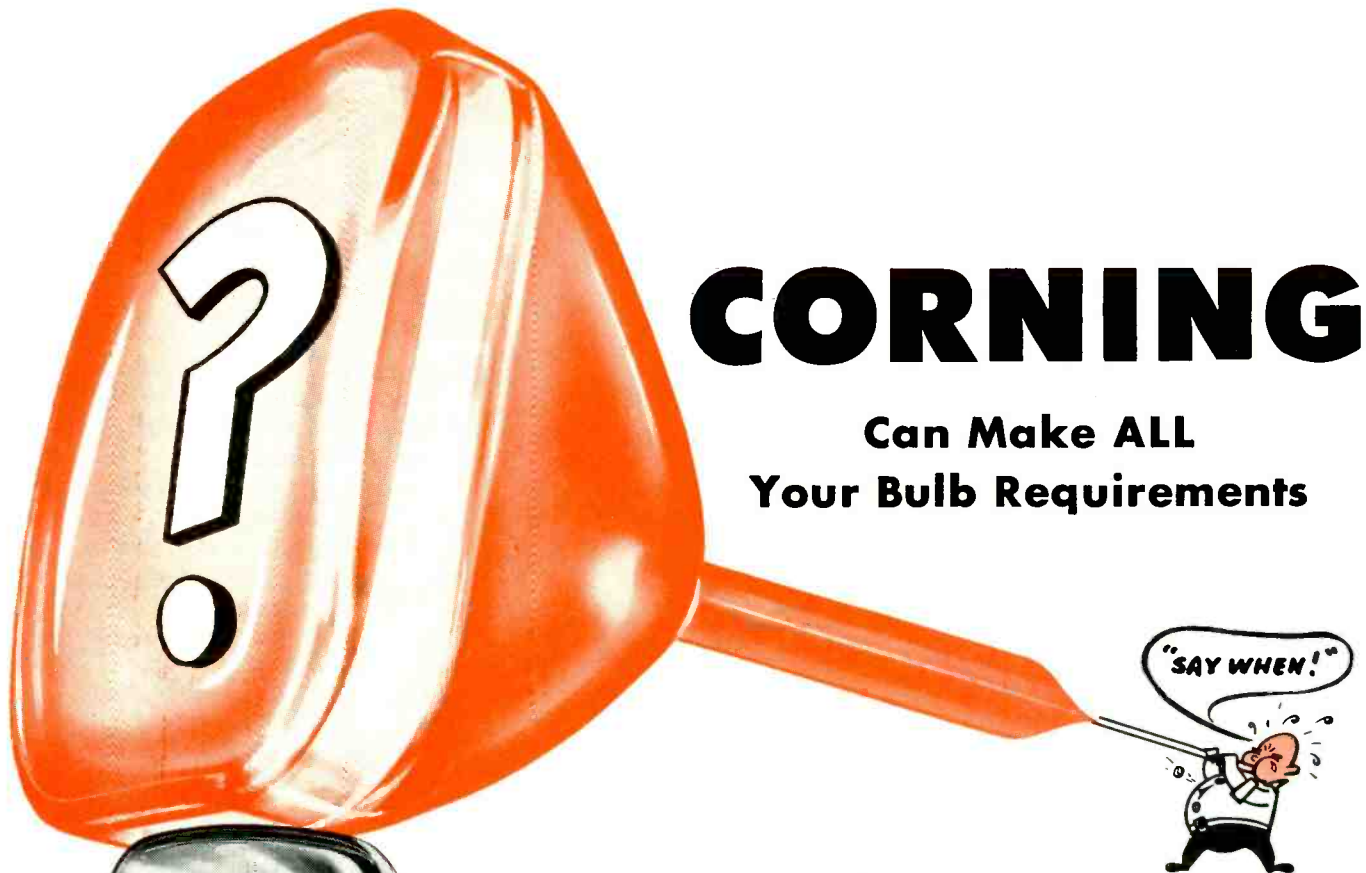

# CORNING

Can Make ALL  
Your Bulb Requirements

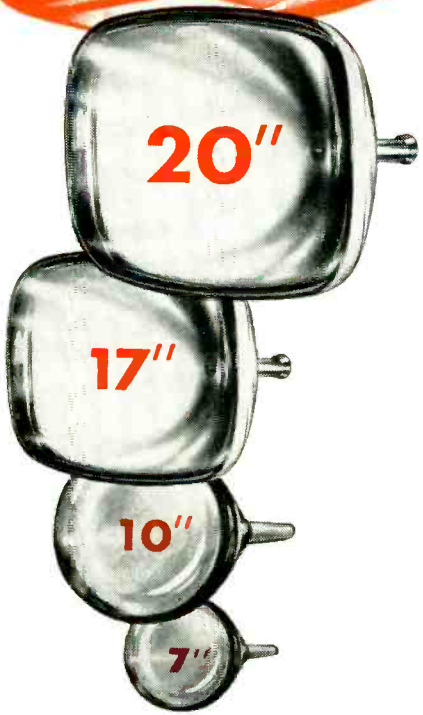

The recently announced 20" *all-glass* television bulb illustrates how tube manufacturers can always look to Corning for the latest developments. There are excellent reasons for this. The adaptability of glass in the hands of Corning technicians is one thing. For another, glass manufacturing methods are flexible. *All-glass* bulbs paced the 1950 trend to rectangular shapes and larger sizes, and continue to lead in 1951.

Size is only part of the story. Specially designed automatic machinery permits manufacturing of *all-glass* TV bulbs on a mass production basis. Corning engineering and research are constantly improving quality, strength and over-all dimensional precision in an effort to help you make the best tubes possible.

It will pay *you* to look to Corning for *all* of your bulb requirements.



**CORNING GLASS WORKS, CORNING, N. Y.**

*Corning means research in Glass*

ELECTRONIC SALES DEPARTMENT — ELECTRICAL PRODUCTS DIVISION

1851 • 100 YEARS OF MAKING GLASS BETTER AND MORE USEFUL • 1951



# METAL on PLASTIC!

Electrostatically Shielded Housing



Instrument Panel

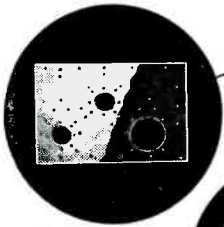

Special Commutator

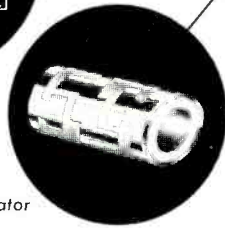

that's  
*Metaplast*

the easy, proved way  
to combine conductor and  
non-conductor **IN ONE PIECE**

to simplify electronic designs  
and assemblies

★ to increase metals'  
corrosion resistance

★ to cut production costs

**Metal-Plated Plastics** combine the qualities of metals as conductors and plastics as insulators to serve a wide variety of unique purposes unfulfillable by a single material. In any application where intricate shapes of conductor and insulator, or thin layers of metal are needed, Metal-Plated Plastics have proved extremely useful. Typical examples are: radar piping, printed circuits, special commutators, slip rings, shielded housings, loop antennae, airplane antennae, Faraday shields, condensers, instrument panels, wave guides, piezo-electric crystals, contacts for electrical leads.

**The Metaplast Process** electroplates a smooth non-porous metal coating, in any thickness, on non-conductive surfaces. Any metal can be used to enhance the vibration and temperature resistance and dimensional stability of the plastic. Superior corrosion resistance is obtained by eliminating the bi-metallic couple resulting from plating one metal over a dissimilar metal.

**Physical Properties of Metal-Plated Plastics** are limited only by the base material, the metal deposited—and the imagination. It is possible to produce a copper plate having a tensile strength of 40,000 p.s.i. and an elongation of 25%. Plating can be varied to give a soft or hard deposit, and finished to any type surface from dull matte to high polish. Absorption of oils, solvents and moisture is eliminated by the continuous metal film preventing swelling and distortion of parts. Temperature resistance is extended 40-50 degrees.

**Metaplast also deposits metal** on all plastics by means of High-Vacuum. This application is for special purposes inasmuch as the thickness of metal is microscopic as compared to electroplated metal.

**Metaplast Silver Conductive Paints**—especially compounded for all printing, spraying and painting processes—are available in a wide variety of formulas. They consist of a lacquer, varnish or other coating medium containing a silver powder in various percentages. They are excellent for making printed circuits. There's no worry about corrosion products as the paint films dry: all corrosion products of silver (sulfides, chlorides, etc.) are good conductors. These paints are sold by the Troy ounce. Write today for Bulletin 51.

**If Your Problem** can be solved by any special application of the Metaplast Process, High-Vacuum or the Metaplast Silver Conductive Paints, outline it to us. We'll gladly tell you of its possibilities.

**Send Us Your Blueprint or Plastic Sample**—molded or machined—for our quotation. We plate to your specifications—in any quantity. Your inquiry involves no cost or obligation.

*Metaplast*

PROCESS, Inc.

9-17 37th Ave., Long Island City 1, N. Y.

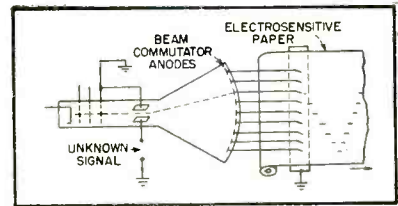

FIG. 3—High-speed beam commutator scanning system

electronic equivalent. An electron-beam commutator can be used, see Fig. 3. Here, the beam of the tube is deflected by the signal to sweep across a series of plates which form the commutator. If the beam current, a few microamperes or a milliampere at most, is insufficient to mark the electrosensitive chart paper, an ordinary triode operating as an on-off switch can be added for each stylus segment. A recorder of two percent accuracy would require 50 segments or 25 twin-triode tubes. This may be expensive, but not excessively so. Such a bank of triodes can also be applied to a mechanical pickup commutator to lessen friction due to contact burning, see Fig. 4.

A beam commutator tube may be avoided by a step-threshold system, using only the triodes, progressively biased, and the stylus segments, see Fig. 5. For any given value of input signal, some of the switching tubes will be beyond cut-off and some will be at full conduction, except one particular tube whose bias will allow it to amplify the locally generated carrier and hence mark at the appropriate stylus segment. If the electric paper had a sharp threshold of marking, any one of several systems could be applied directly to the segments without the use of switching tubes.

Sweep commutation systems, both mechanical and electronic, can be applied. Unlike closed-cycle servo null systems, sweep null systems are fast, not only because all moving parts run at a constant maxi-

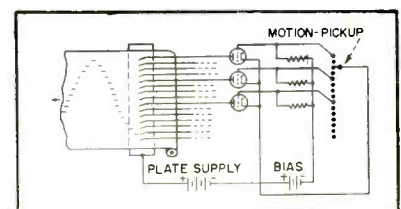
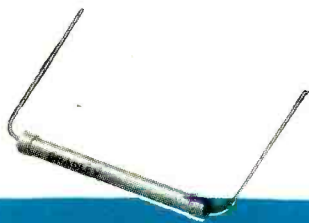

FIG. 4—Use of triodes as switches

# WHY BRADLEY RECTIFIERS CONSISTENTLY EXCEL IN

# PERFORMANCE



**SE8 SERIES — SELENIUM  
FOR HIGH VOLTAGE USES**



**CX14 SERIES — COPPER OXIDE  
FOR INSTRUMENTS**



**SE11 SERIES — SELENIUM  
FOR HIGH CURRENT USES**

## PHOTOELECTRIC CELLS



Bradley Luxtron\* photoelectric cells convert light directly into electrical energy without external power source. Wide range of models, sizes and shapes available.

\*T. M. Reg. U. S. Pat. Off.

**PERFORMANCE AS RATED** is not a hoped for characteristic with Bradley selenium or copper oxide rectifiers. It can be counted upon and planned for.

**THROUGHOUT MANUFACTURE** our rectifiers are subjected to the most rigorous quality control technique ever developed for rectifiers — the Bradley Vacuum Process.

**IN BRADLEY SELENIUM RECTIFIERS**, our unique and exclusive vacuum method eliminates impurities in the raw selenium, prevents contamination during manufacture and assures a secure, even bonding of selenium to the plates.

**IN BRADLEY COPPER OXIDE RECTIFIERS**, the 24K gold counter electrodes and contact surfaces are placed on the copper oxide plates under high vacuum.

**PERFORMANCE AS RATED** is thus an inherent characteristic of Bradley rectifiers — a constant that assures stability of power conversion in your product under all conditions.

*BRADLEY RECTIFIERS... FOR PERFORMANCE AS RATED*

**BRADLEY LABORATORIES, INC.**  
82 MEADOW STREET, NEW HAVEN 10, CONNECTICUT



# COPPER AND BRASS

## now scheduled

### for improved delivery

# ON DEFENSE ORDERS

If you need brass or copper to fill a defense order (DO), get in touch with your nearest Chase warehouse. And ask about our deliveries. Mill shipments are favorable. Warehouse shipments are prompt, and in many cases we can make immediate delivery of small "DO" orders right from stock. With our own mills and with 23 Chase warehouses in large industrial cities from coast-to-coast there is no one in a position to give you better service on your brass and copper requirements.

**ROTATING BANDS.** We are also in an excellent position to supply copper and gilding metal rotating bands of all sizes, clean and properly annealed for trouble-free banding. Your inquiries are invited.

**Chase**  *the Nation's Headquarters for*  
**BRASS & COPPER**  
 WATERBURY 20 CONNECTICUT      SUBSIDIARY OF KENNECOTT COPPER CORPORATION

THIS IS THE CHASE NETWORK . . . *handiest way to buy brass*

ALBANY† ATLANTA BALTIMORE BOSTON CHICAGO CINCINNATI CLEVELAND DALLAS DENVER‡ DETROIT HOUSTON† INDIANAPOLIS KANSAS CITY, MO. LOS ANGELES MILWAUKEE  
 MINNEAPOLIS NEWARK NEW ORLEANS NEW YORK PHILADELPHIA PITTSBURGH PROVIDENCE ROCHESTER† ST. LOUIS SAN FRANCISCO SEATTLE WATERBURY (†Sales Office Only)

**FOR EXTRA FAST STOPS**

**STARTS**

**REVERSES**



**New TYPE R-24  
process control motor**

Holtzer-Cabot Type R-24 motors are designed especially to provide the rapid starts, stops and reverses required by modern, high-speed process control equipment. Extremely low rotor inertia, *plus* high accelerating and decelerating torques, provide extremely quick response. Tests show that, with the dynamic braking connection, the unloaded rotor will *always stop within three-quarters of one revolution!* On geared motors, of course, this means that the output shaft stops in a very small fraction of a revolution.

These motors are 2-phase, squirrel-cage, nonsynchronous induction type. For operation on a single-phase circuit, a capacitor is used in series with one phase. Special high impedance windings are available, suitable for matching standard power tubes.

Available speeds, 1300 RPM (1800 synchronous speed) to  $\frac{3}{4}$  RPM (geared), with torque ratings from 0.5 to 75 oz. in. Can be provided for odd voltages and frequencies, with ball or sleeve bearings. These motors are ideal for Servo-Mechanisms.



**INVESTIGATE NOW . . .** Holtzer-Cabot welcomes inquiries involving special motors

**HOLTZER-CABOT**

DIVISION OF NATIONAL PNEUMATIC CO., INC.

**BOSTON 19, MASSACHUSETTS**

*"Manufacturers of fine electrical apparatus since 1875"*



# A Better Product through *Sound* Research



WITH *Magnecorder*  
High Fidelity Tape Recorders For Industry

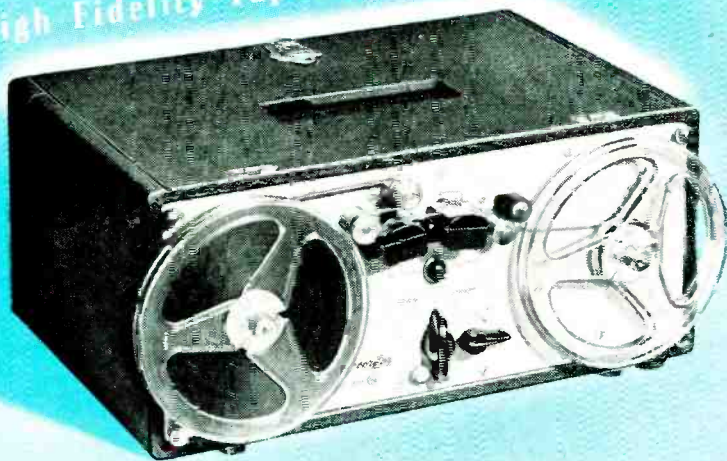

NOISE ANALYSIS • PROCESS CONTROL

VIBRATION TESTS • TELEMETERING

Used by more engineers  
than all other professional  
tape recorders combined

**Magnecord, Inc.**

360 NORTH MICHIGAN AVENUE  
CHICAGO 1, ILLINOIS

### Write for NEW CATALOG

Magnecord, Inc., Dept. EA-3  
360 N. Michigan Ave., Chicago 1, Ill.  
Send me further information on Magnecord  
tape recordings for industrial "Sound" Research.

Name.....

Company.....

Address.....

City..... Zone..... State.....

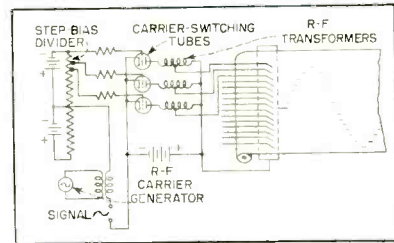

FIG. 5—Progressively biased switching system

imum speed with no time lost for stopping and starting about the point of marking, but also because no speed need be sacrificed to cure hunting instability, see Fig. 6.

In this example, a motor repeatedly sweeps a potentiometer and also a commutator on the same shaft. At the instant when the potentiometered voltage equals the unknown, a null-operated switch, electronic if fast response is desired, connects the marking current to the stylus commutator segment being swept at that instant, thus marking at the correct point on the chart paper. An all-electronic equivalent is made possible by using a beam commutator or a series of biased triodes as commutator segments and a saw-tooth sweep instead of a motor-driven sweep, see Fig. 7. The sweep rate must be high enough to take at least several samples of each signal impulse.

The accuracy or resolution of the fixed segmented stylus system is ultimately determined by the commutation accuracy, the number of segments and by the mechanical precision of the apparatus. The latter is the precision of nonmoving parts, analogous to the markings on a ruler. Hence, this system avoids many of the dynamic inaccuracies of moving styli and, rather, depends upon our more basic standard of accuracy, the static unit of length.

With a segmented bar stylus the number of segments may be great

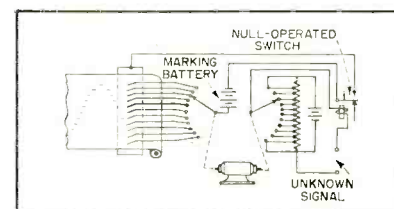

FIG. 6—Motor-driven sweeping commutator and potentiometer



# face value\*

It doesn't take an expert to pick out a Zetka picture tube. Seen in use, it is amazingly brilliant, clear and sharply focused. For many reasons: only Zetka utilizes the power-tube method of production plus a hypersensitive inspection of the tube screen. The extremely long pumping process insures an ultra-hard, gas-free tube that will out-perform any similar product on the market. And, as a final precaution, each and every Zetka tube (no spot checking permitted) is set-tested in the factory before being shipped. It makes sense, therefore, doesn't it, that, if you're building your reputation on face value, the Zetka tube, in all its brilliance, will be your most outstanding feature. Rectangulars and rounds in 16", 17", 19" and 20".



# zetka

# Zetka

THE ARISTOCRAT OF TELEVISION TUBES

**TELEVISION TUBES, INC.** 131-137 GETTY AVE. • CLIFTON, N. J.

For 37 years, Zetka has been a respected name in the radio and television industry.



# Need Thin Gage Bimetal?

General Plate makes

# Truflex

THERMOSTAT  
METAL

as thin as .0005"

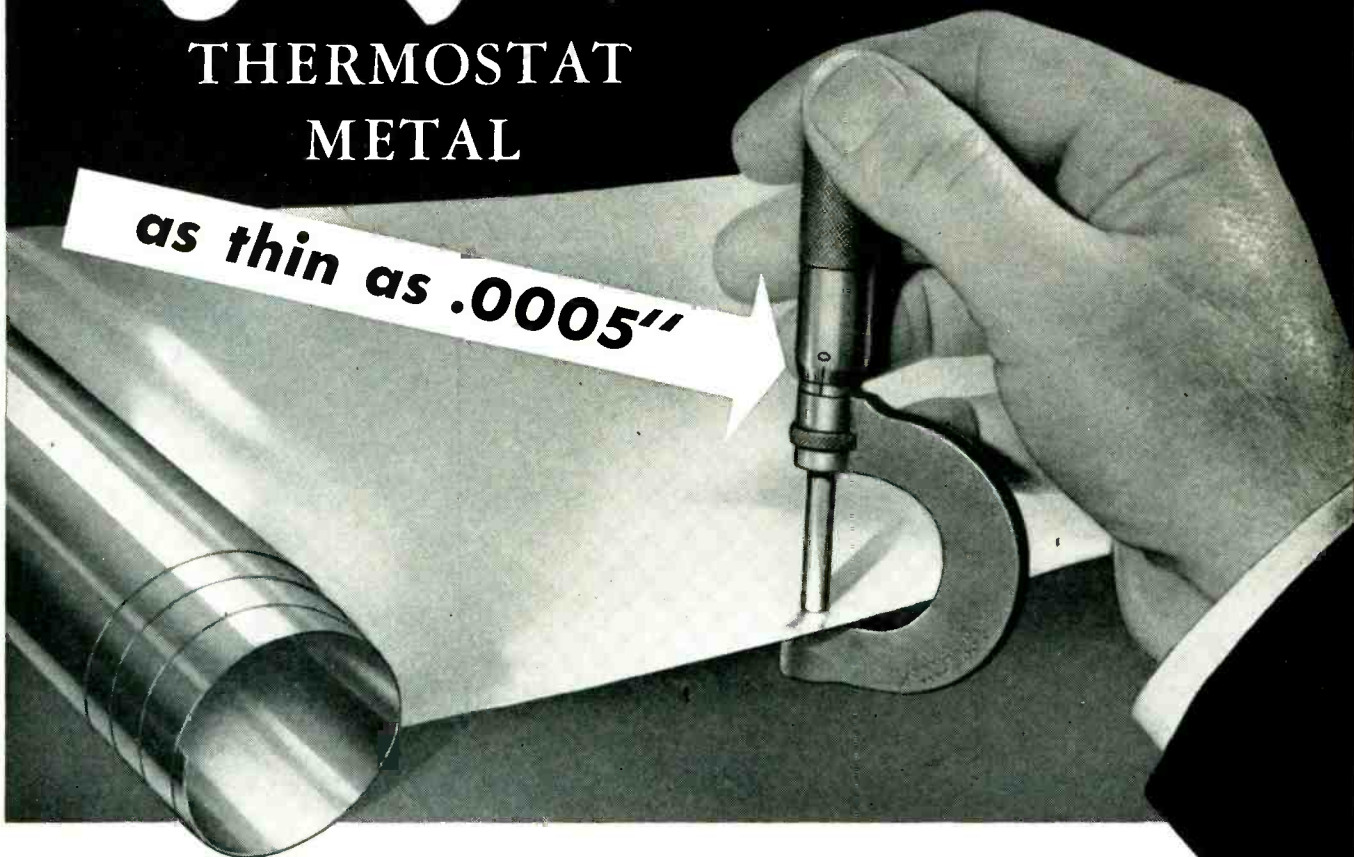

Have you a thermostat metal problem requiring exceptional thin gage metal? General Plate can provide the solution with *Truflex* bimetal in thicknesses down to .0005" or  $\frac{1}{4}$  the thickness of a human hair. And even in this unusual thinness, every succeeding order comes to you an exact duplicate of the original . . . uniform in tolerances, temperature reaction and performance.

General Plate thin gage *Truflex* Thermostat metal applications include instruments, thermometers and electronic equipment . . . as quick-acting thermostats where space and mass is at a pre-

mium . . . as thermal compensating coils or springs in thinner than "hairspring" dimensions.

General Plate manufactures *Truflex* Thermostat metal in a complete line of combinations to meet practically all requirements. It is available in strip, coils, sheets, ranging in widths from .020" to 8" . . . or in fabricated parts ready for installation into your products. Write for information and engineering assistance.

## GENERAL PLATE

Division of Metals and Controls Corporation  
30 FOREST ST., ATTLEBORO, MASS.

### OTHER GENERAL PLATE PRODUCTS INCLUDE

Precious to base metal laminations  
Base metal laminations  
Alcuplate (copper or aluminum)  
Silver solders  
Laminated contacts, buttons, rivets  
Platinum-fabrication-refinery  
Age-hardening Manganese Alloy 720

50 Church St., New York, N. Y. • 4326 N. Elston Ave., Chicago, Ill. • 757 W. Third St., Mansfield, Ohio • Detroit, Mich. • Los Angeles, Calif.

YOU CAN BE **SURE**.. IF IT'S  
**Westinghouse**

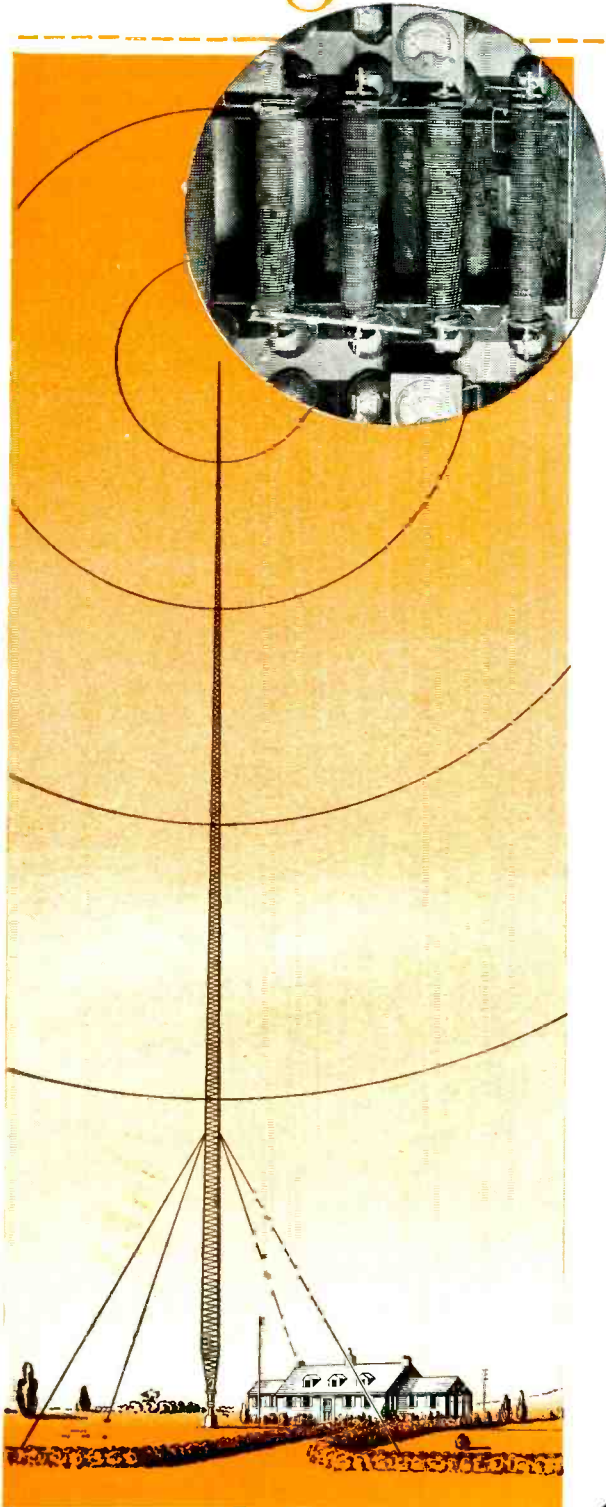

# No Program Interruptions

**How KDKA MAKES SURE  
with Selenium Rectifiers**

You, too, can have a power rectifier that is good for the *life* of your transmitter. Gone forever will be those costly program interruptions caused by the sudden necessity of replacing power tubes.

Since Selenium stacks were installed at KDKA, power rectifiers are no longer critical components. In addition to many years of service, these Selenium rectifiers provide other benefits. No warm-up period or filament power required . . . ability to withstand relatively high inverse surges . . . takes temporary or prolonged overloads without damage.

Why not be assured of stable operation of your power rectifier . . . of program continuity at full signal strength. Your nearby Westinghouse representative will tell you how to get the job-proved Rectox. Ask him for a copy of DB-19-025 or write Westinghouse Electric Corporation, Post Office Box 868, Pittsburgh 30, Pa. J-21568



**Westinghouse**  
*Rectox*

**Rectifiers & Chargers for  
ALL INDUSTRIES**



*Announcing...*  
IMPROVEMENTS IN THE

# BALLANTINE BATTERY OPERATED ELECTRONIC VOLTMETER

Achieving a tenfold increase in sensitivity, higher input impedance, improved low frequency response and substantial reduction in size and weight.

## VOLTAGE RANGE:

100 microvolts to 100 volts in 6 decade ranges.

## INPUT IMPEDANCE:

2 megohms shunted by 8 mmfd on high ranges and 15 mmfd on low ranges.

## FREQUENCY RANGE:

2 cycles to 150,000 cycles.

## ACCURACY:

3%, except 5% below 5 cycles and above 100,000 cycles.

- Available multipliers increase the voltage range to 1,000 or 10,000 volts.
- Available precision shunt resistors permit the measurement of AC currents from 1 ampere down to one-tenth of a microampere.
- Features the well-known Ballantine logarithmic voltage and uniform DB scales.
- Battery life over 100 hours.
- Can also be used as a flat pre-amplifier with a maximum gain of 60 DB. Because of the complete absence of AC hum, the amplifier section will be found extremely useful for improving the sensitivity of oscilloscopes.

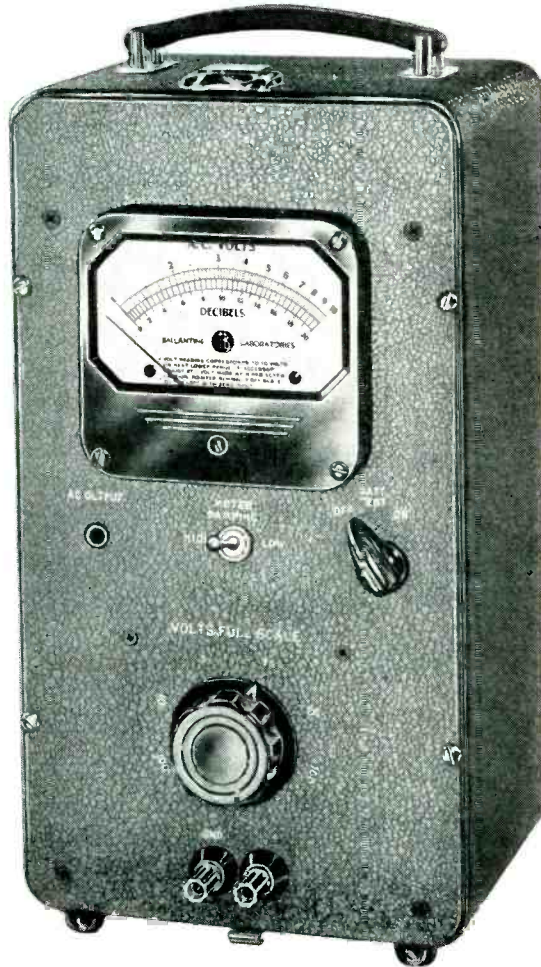

### MODEL 302B

Size: 6 $\frac{3}{8}$ " x 7 $\frac{1}{2}$ " x 12 $\frac{3}{8}$ "  
Weight: 14 lbs.  
Price complete with cover and batteries: \$225.

For further information on this Voltmeter and the Ballantine Model 300 Voltmeter, Wide-Band Voltmeters, Peak to Peak Voltmeters and accessories such as Decade Amplifiers, Multipliers, and Precision Shunt Resistors, write for catalog.

# BALLANTINE LABORATORIES, INC.

100 FANNY ROAD, BOONTON, NEW JERSEY



TUBES AT WORK

(continued)

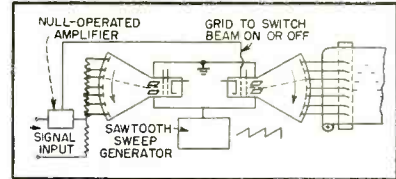

FIG. 7—Beam-commutation potentiometer

enough to give a highly accurate tracing, yet this tracing may appear broken into discrete dots such as those shown in the figures. The remedy is closer spacing or angled overlapping of the stylus segments, thus producing a continuous-line recording.

Several signals may be simultaneously recorded by one segmented stylus. If, for example, three motion-sensitive commutators are used with one stylus, the traces may be identified by having faint marking from signal No. 1, heavy marking from No. 2 and regularly interrupted marking from No. 3.

The ultimate high-frequency response of this system, aside from any commutation or sweep attachments, depends upon the time and intensity required to mark the paper. That is, transient pulses will be reproduced at full amplitude until their time duration is too short to cause marking of the chart paper. Pulse-stretching of very short transients and intensity-modulation of the stylus marking current should make possible a frequency range of several thousand cycles per second.

Conventional chart paper drives may be used for recording low-frequency phenomena. However, for high-frequency phenomena, the paper speed must be greater. To have a millisecond pulse occupy an inch of chart paper requires a paper drive of 83 fps, which may involve the waste of a large amount of chart paper in getting up to the speed required for recording. It is suggested that a short length of paper be wrapped around the periphery of a continuously revolving motor-driven drum. A pair of fast switches, electronic if necessary, can limit the oscillogram to just the one revolution, and can also be used to initiate the phenomena being measured, such as a nerve action-potential. Long, fast records can be driven by having a strip of straight, nonrolled chart paper sud-

# MORE FOR YOUR MONEY

# WITH **BENDIX SCINFLEX** ELECTRICAL CONNECTORS

## MOISTURE PROOF

### PLUS

- Pressure Tight
- Radio Quiet
- Single-piece Inserts
- Vibration-proof
- Light Weight
- High Insulation Resistance
- Easy Assembly and Disassembly
- Fewer Parts than any other Connector
- No additional solder required

The importance of a completely moisture-proof electrical connector can scarcely be exaggerated. But in addition to this important characteristic, there are a host of other exclusive features that make Bendix Scinflex connectors outstanding for dependable performance. For example, the use of Scinflex dielectric material, an exclusive Bendix development of outstanding stability, increases resistance to flash over and creepage. In temperature extremes, from  $-67^{\circ}\text{F}$ . to  $+275^{\circ}\text{F}$ . performance is remarkable. Dielectric strength is never less than 300 volts per mil. If you want more for your money in electrical connectors, be sure to specify Bendix Scinflex. Our sales department will be glad to furnish complete information on request.

### PLUS

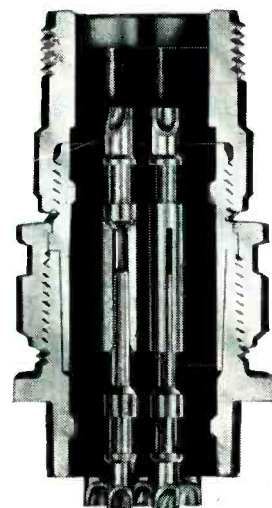

#### SHELL

High strength aluminum alloy . . . High resistance to corrosion . . . with surface finish.

#### CONTACTS

High current capacity . . . Low voltage drop.

#### SCINFLEX ONE-PIECE INSERT

High dielectric strength . . . High insulation resistance.

**SCINTILLA MAGNETO DIVISION of**  
SIDNEY, NEW YORK

Export Sales: Bendix International Division, 72 Fifth Avenue, New York 11, N. Y.

FACTORY BRANCH OFFICES:

117 E. Providencia Ave., Burbank, California • 23235 Woodward Ave., Ferndale, Michigan • 7829 W. Greenfield Ave., West Allis 14, Wisconsin.  
582 Market Street, San Francisco 4, California





**EFFICIENCY IS THE KEYNOTE!**

**NEW DRIVE FOR PRODUCTION EFFICIENCY  
MEANS NEW DEMAND FOR INTER-COM SYSTEMS!**

Model  
HU-15V  
HU-24V



The model HU-15V is a medium sized speaker suitable for all paging and talk-back applications. All ATLAS paging speakers are designed to offer a maximum sensitivity in talk-back systems.

The weather proof universal line matching transformers are easily attached to any model. Designed for constant impedance, constant voltage systems and 50 ohm lines.

The model HU-24V is an oversized speaker having the obvious advantage of a longer air column length. Suitable for music as well as speech in industrial applications.

Our expanding anti-aggression effort calls for quick conversion of many plants to war production. New levels of efficiency must be attained.

For full efficiency, a modern inter-com and paging system is a must.

The demand for good sound equipment will be heavy. Will you be ready? NOW is the time for you to establish yourself as a dependable source of industrial electronic equipment.

ATLAS can help you build a profitable sound equipment business. We are ready to supply you with equipment to meet every conceivable inter-com and paging requirement.

Model TP-15V . . . TP-24V

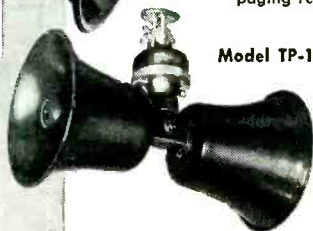

The TP type speakers are available in two sizes. These dual two-way speakers produce two speaker results from a single location for long corridors, hallways, etc.

All ATLAS speakers are priced Right! COMPARE! But remember, we make no compromise with quality.

Don't miss your best new business opportunity in years. Write us TODAY for full details.



**ATLAS** Sound Corp.

1450 39th Street, Brooklyn 18, N. Y.

in Canada: Atlas Radio Corp., Ltd., Toronto, Ont.

## CONTINUOUSLY VARIABLE DUAL - HEAVY DUTY REGULATED DC SUPPLIES

### ✓ FEATURES

- ✓ DUAL regulated outputs, continuously variable, 0 to 600 volts.
- ✓ Maximum current 200 milliamperes each, or 400 combined.
- ✓ Regulation better than .5%.
- ✓ 6.3 volts AC at 10 amperes center-tapped.
- ✓ Ripple voltage less than 10 millivolts.
- ✓ Stabilized bias supply.



### MODEL D6 POWER SUPPLY

Dual Output . . . Heavy Duty

✓ Request Bulletin No. 53 for Detailed Specifications

**Oregon** ELECTRONICS  
MFG. CO.  
206 S.W. WASHINGTON ST., PORTLAND 4, ORE., U.S.A.

# Paris International Trade Fair

FOUNDED 1904

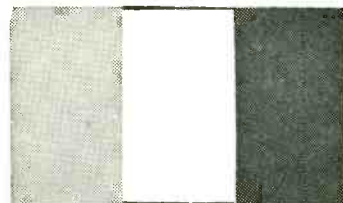

over 10,000  
exhibitors  
from France  
and abroad

April 28  
to May 14

Parc de la Foire de Paris  
Porte de Versailles  
Paris

Special Sections:

ELECTRONIC MANUFACTURING,  
COMMUNICATIONS

and

INDUSTRIAL ELECTRONICS

### INFORMATION

French Chamber of Commerce  
of the United States

630 Fifth Ave. • New York 20, N. Y.

# LITTON INDUSTRIES NEWS

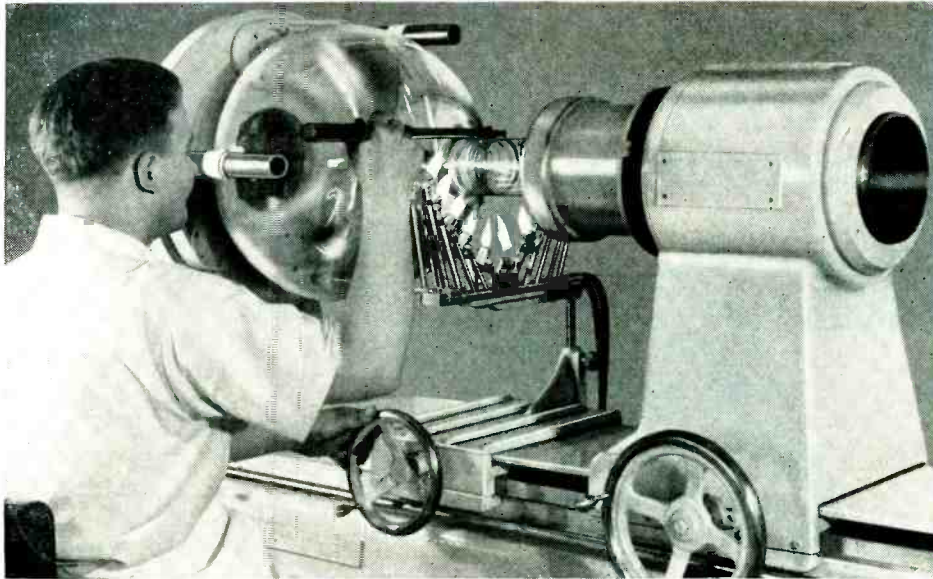

## LITTON GLASSWORKING LATHES SPEED PRECISION ASSEMBLY OF TV KINESCOPE, VACUUM TUBES

Modern vacuum tubes have extremely close alignment tolerances. Often, sub-assemblies must be separately aligned before junction. During sealing, both assemblies must be rotated in perfect phase to maintain this alignment.

Versatile, adaptable Litton Glassworking Lathes meet these requirements. They are built on a normalized cast iron bed, with precision ground ways and axial alignments of highest accuracy and positive phase. The lathes will chuck and hold units such as copper anodes to runouts of .001".

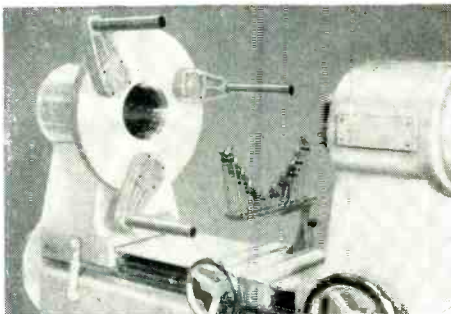

Close-up of spindle head, Litton Model K lathe, showing exceptionally large diameter opening of universal chuck

Air passages are arranged to avoid contamination, yet permit use of neutral gasses when sealing glass to metal. Burners provide the narrowest possible heating area commensurate with ample total heat. Continuously variable spindle speed, which makes possible much glassworking without blowing, is optional on all models. Foot pedals control the air or neutral gas supply, and the oxygen and gas volume. Convenient hand controls govern carburetion and air intake to the spindles.

Leading TV tube makers use Litton Glassworking Lathes to speed production of kinescope tubes 10" to 27" in diameter. Manufacturers find that the speed and handling ease of Litton lathes enable glassworkers to seal tube funnels to domes in minimum time—with complete control of glass distribution. Since most manufacturers align sub-assemblies on the lathe, the accurate phasing of Litton spindle heads is also an important factor.

Reliable Litton Glassworking Lathes are adaptable to the widest possible variety of glassworking jobs. Five models offer a choice of radial clearance ranging from 4" to 17½", and axial working lengths from 20¾" to 75½".

## LITTON SPOTWELDERS OFFER HIGH POWER, EXTREME FLEXIBILITY FOR PRECISION JOBS

Litton Model A Precision Spotwelder offers broad applicability of use in the manufacture of vacuum tubes. It makes possible the quick altering of production setups. Rated 2 kva continuous duty, it efficiently handles average sized



or very precise jobs. Accurate alignment and absence of side play permit butt welding or parallel welding of small wires without rolling. Foot pedals and switches control top mandrel and power supply. Model A spotwelder has 6½" throat depth and extension jaws can be added.

## SPOTWELDER TIMER

A new timer for the Litton Model A Spotwelder has been developed by Litton Industries and will be available for delivery soon. The timer employs two simple controls. One adjusts weld time in steps of 1, 2, 3, 5, 7, 10, 15, 25 and 60 cps. The other adjusts heat control in 6 steps. Proper adjustment of these controls makes possible precision welds up to the 2 kva rating of the welder.

## LITTON INDUSTRIES

SAN CARLOS, CALIFORNIA, U. S. A.

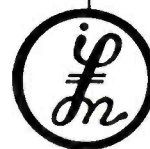

DESIGNERS AND MANUFACTURERS of:  
Glassworking Lathes and Accessories,  
Vertical Sealing Machines, Burner Equipment,  
Precision Spotwelders, Oil Vapor  
Vacuum Pumps, Glass Baking Ovens,  
Vacuum Tubes and Tube Components,  
Magnetrons, High Vacuum Molube Oil,  
Microwave Equipment.



take a look INSIDE—and see why

**CHICAGO**

**IS TODAY'S  
PREFERRED  
TRANSFORMER**

**CHOICE OF ENGINEERS—  
CHICAGO'S Sealed-in-Steel  
New Equipment Line**

Here's the actual proof that demonstrates why CHICAGO units are ideal for application in new equipment, why they meet the express requirements of today's most-used tubes and circuits. Here are the "inside" facts of CHICAGO "Sealed-in-Steel" design:

1. Drawn steel cases for "steel wall" protection against moisture, for unsurpassed strength and rigidity, for convenient mounting, and for compact, streamlined appearance.
2. Uniformly-wound precise coil structures, for cool operation and superior electrostatic shielding in power units, and minimum leakage with optimum coupling in audio units.
3. Core of high-grade, non-aging silicon steel brought to high efficiency by scientific heat-treating in CHICAGO'S own annealing ovens.
4. Core and coil vacuum-impregnated with varnish; alternating vacuum and pressure, combined with heat, removes all moisture. Final high-temperature baking achieves a perfectly impregnated coil and core locked against vibration.

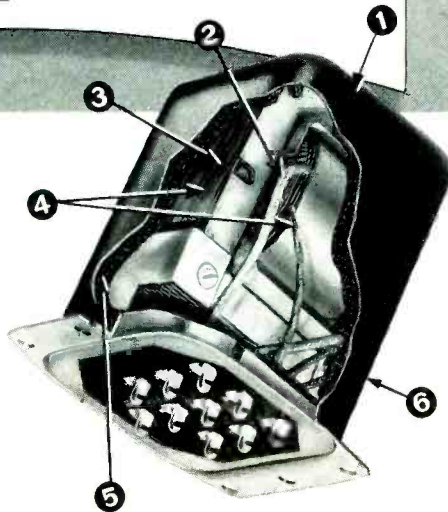

5. Special, moisture-resistant compound fills all internal free space. Compound prevents corrosion and helps maintain cool operation. Heat conduction is faster than in conventional mountings where coil and core are surrounded by air.
6. Units are checked by quality controls throughout manufacture; inspected for materials and workmanship; tested electrically at various stages; rigid concluding tests insure efficient performance and long, dependable operating life.

**Available in 4 Constructions to Meet Most Requirements**

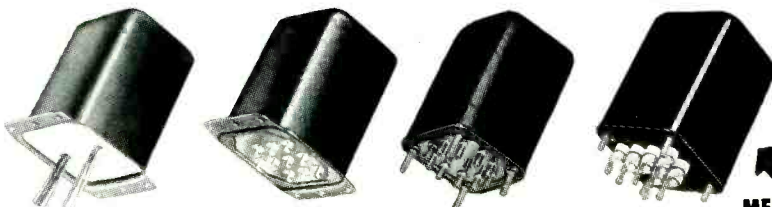

- C-Type.** With 10" color-coded stripped and tinned leads brought out through fibre board base cover. Flange-mounted unit.
- S-Type.** Steel base cover fitted with phenolic terminal board. Convenient numbered solder lug terminals. Flange-mounted unit.
- B-Type.** Steel base cover soldered into case. Phenolic terminal board with solid steel pin terminals. Stud-mounted unit.
- H-Type.** Steel base cover deep-seal soldered into case. Terminals hermetically sealed. Ceramic bushings. Stud-mounted unit.

**MEETS  
JAN-T-27  
SPECS**

**SEND FOR "NEW EQUIPMENT TRANSFORMER" CATALOG**

You'll want the full details on CHICAGO'S New Equipment Line. Lists Sealed-in-Steel units for all purposes: Power, Bias, Filament, Filter, Plate, Reactor, Audio (in 3 frequency ranges), JAN-T-27, Modulation, etc. Write for your Free catalog today—or get a copy from your distributor.



**CHICAGO TRANSFORMER**

DIVISION OF ESSEX WIRE CORPORATION

3501 ADDISON STREET • CHICAGO 18, ILLINOIS



denly snatched between a pair of oppositely turning drive rollers whose speed is reinforced by fly-wheels or by a heavy drive motor.

**Need for Improvement in Selenium Rectifiers**

BY J. T. CATALDO  
*Project Engineer  
Signal Corps Engineering Laboratories  
Fort Monmouth, New Jersey*

SELENIUM RECTIFIERS are finding more and more widespread use in the electronics industry today. Although the unidirectional conductivity of selenium was investigated as early as 1878 by R. Sabine, it was not until 1938 that selenium rectifiers, as such, appeared commercially in this country.

Today, because of the ever increasing requirements of light weight, compactness and economy and because of shortages in many types of tubes, selenium rectifiers have found application in almost every branch of electronics. Their most popular application has been as a rectifier to convert a-c power to d-c power for tube circuits.

*Limitations*

As is usually the case with new components, certain limitations to their use exist. For commercial application, the inherent limitations of selenium rectifiers do not present a difficult problem. However, because of rigid military equipment requirements, certain improvements have to be made in this field. The present major requirements for

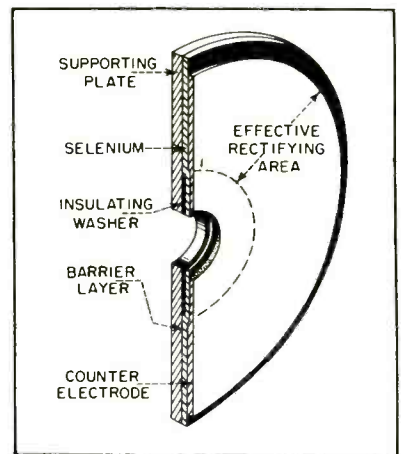

Cross section of selenium rectifier plate. The center area around the assembly hole is coated with an insulating varnish or a thin insulating washer prior to application of the selenium



*Atmosphere* unlimited...



## Northern Test Chambers

# PROVE YOUR PRODUCT

Assure maximum value from each research dollar invested and from every hour of human effort expended in your development or manufacturing program by relying on Northern-Zaleski test chambers for complete, accurate test data—the soundest foundation on which to base your operation.

Northern-Zaleski atmospheric test chambers (with fully automatic cycling and recording systems, if desired) are your assurance of complete dependability and highest precision in meeting all test requirements. Temperature ranges of  $-150^{\circ}\text{F}$ . to  $+200^{\circ}\text{F}$ ., humidity ranges of 10% to 98%, and simulated altitude ranges of 0 to 100,000 feet are available in standard chambers of from 3 to 800 cubic feet. Field construction to 25,000 cubic feet.

*Laboratory facilities to run JAN spec tests*

*Research and development services available  
Test chamber repair-rebuilding-maintenance*



*makes the difference!*

*Northern-Zaleski, Limited*

PRATT OVAL, GLEN COVE, LONG ISLAND, N. Y.





## MIDGET CONDENSER MICROPHONE

for **PRECISION SOUND MEASUREMENTS** or **HIGH QUALITY SOUND RECORDING**

- Rugged Construction
- Exceptional Calibration Stability
- Unaffected by Variations in Humidity

Built to give years of service without adjustments and without change in calibration. Even without dessicators, Kellogg Midget Condenser Microphones show no detectable drift in laboratory service. Proven in use for optimum performance for over 15 years.

### PRINCIPAL CHARACTERISTICS:

**RESPONSE**—the response for the cavity and coupler sound measurements type Model A is about -58db when referred to 1 volt/dyne/cm<sup>2</sup>. This response is flat to within 1db from 100 to 7000cps and to within 3db from 60 to 10,000cps. The overload on Model A occurs above 140db.

In the free field type Model B the response is about -55db referred to 1 volt/dyne/cm<sup>2</sup>.

This response is flat to within  $\pm 3$ db from 20 to 12,000cps and to within  $\pm 3$ db from 20 to 15,000 cps with the grill removed. The overload level for this model is approximately 130db.

**MATERIAL**—Diaphragm—.001" ST-17 aluminum alloy. All other major components are brass. External surfaces are bright gold plated and lacquered. **CAPACITY**—Approximately 40mmf. **INSULATION RESISTANCE**—100,000 megohms minimum measured at 250 volts. **POLARIZING VOLTAGE**—150-300 volts. 150-225 volts is the recommended range.

Users include government laboratories, universities, audio development laboratories, sound studios and industrial plants manufacturing sound equipment.

Model B is available either uncalibrated or with free field calibration. Prompt delivery on both models — be sure to specify type desired.

Send for full specifications today. Write Dept. 26-C.

# KELLOGG

 SWITCHBOARD AND SUPPLY COMPANY  
Established 1897

MIDGET CONDENSER MICROPHONE

4612 SOUTH CICERO AVENUE • CHICAGO

## STANCOR

# TRANSFORMERS

for every electronic application

450 types carried in stock • Write for catalog.

**STANDARD TRANSFORMER CORPORATION**  
3578 ELSTON AVENUE • CHICAGO 18, ILLINOIS

## PHYSICISTS

And

## SENIOR RESEARCH ENGINEERS

• • •

## POSITIONS NOW OPEN

• • •

Senior Engineers and Physicists having outstanding academic background and experience in the fields of:

- Microwave Techniques
- Moving Target Indication
- Servomechanisms
- Applied Physics
- Gyroscopic Equipment
- Optical Equipment
- Computers
- Pulse Techniques
- Radar
- Fire Control
- Circuit Analysis
- Autopilot Design
- Applied Mathematics
- Electronic Subminiaturization
- Instrument Design
- Automatic Production Equipment
- Test Equipment
- Electronic Design
- Flight Test Instrumentation

are offered excellent working conditions and opportunities for advancement in our Aerophysics Laboratory. Salaries are commensurate with ability, experience and background. Send information as to age, education, experience and work preference to:

**NORTH AMERICAN AVIATION, INC.**

*Aerophysics Laboratory*

Box No. K-4, 12214 S. Lakewood Blvd.  
DOWNEY, CALIFORNIA

Save time by contacting

# UNITED

for the wide range of

## JAN APPROVED GAS RECTIFIERS & THYRATRONS

Complete Technical Data  
Sent On Request

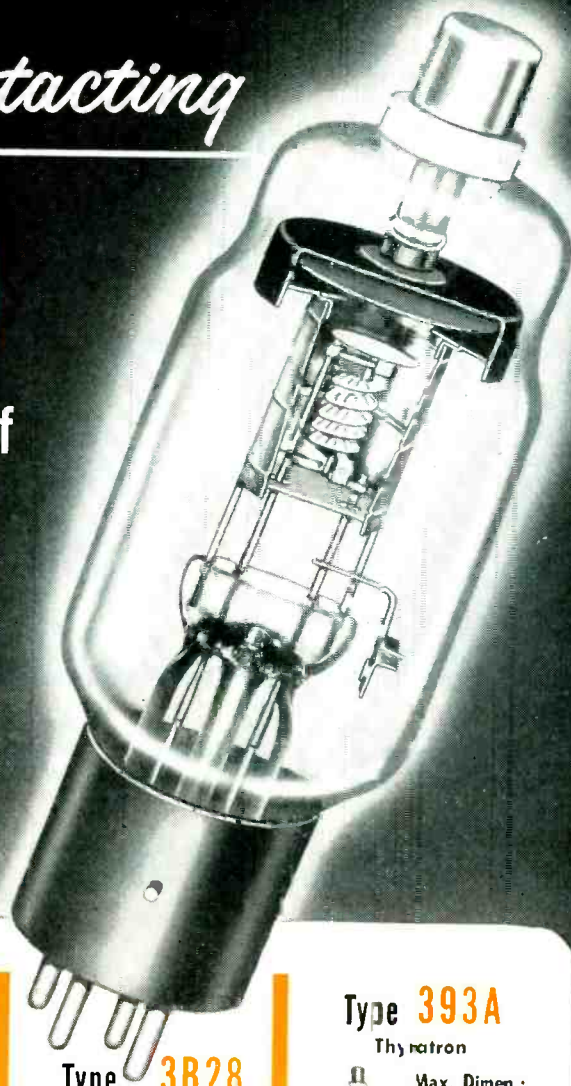

### Type 4B32

Rectifier



Max. Dimen.:  
Ht. 3-1/2"  
Diam. 1-5/16"

Ratings:  
E 5.0 volts  
If 3.75 amps.  
e<sub>px</sub> 10 KV  
Io 2.5 amps.  
Ib 5.0 amps.

Atmosphere:  
Zeron Gas

### Type 323B

Thyatron



Max. Dimen.:  
Ht. 6-9/16"  
Diam. 2-3/16"

Ratings:  
E<sub>f</sub> 2.5 volts  
I<sub>f</sub> 7.0 amps.  
e<sub>px</sub> 1250 volts  
I<sub>o</sub> 1.5 amps.  
I<sub>b</sub> 6.0 amps.

Atmosphere:  
Argon-Mercury

### Type 3B28

Rectifier

Max. Dimen.:  
Ht. 6-5/32"  
Diam. 2-1/16"

Ratings:  
E<sub>f</sub> 2.5 volts  
I<sub>f</sub> 5.0 amps.  
e<sub>px</sub> 10 KV  
I<sub>o</sub> 250 ma.  
I<sub>b</sub> 1.0 amp.

Atmosphere: Xenon Gas

### Type 393A

Thyatron



Max. Dimen.:  
Ht. 6-10/16"  
Diam. 2-1/16"

Ratings:  
E<sub>f</sub> 2.5 volts  
I<sub>f</sub> 7.0 amps.  
e<sub>px</sub> 1250 volts  
I<sub>o</sub> 1.5 amps.  
I<sub>b</sub> 6.0 amps.

Atmosphere:  
Argon-Mercury

### Type 3C23

Thyatron



Max. Dimen.:  
Ht. 3-1/8"  
Diam. 2-1/16"

Ratings:  
E<sub>f</sub> 2.5 volts  
I<sub>f</sub> 7.0 amps.  
e<sub>px</sub> 1.50 volts  
I<sub>o</sub> 1.5 amps.  
I<sub>b</sub> 6.0 amps.

Atmosphere:  
Argon-Mercury

### Type 355A

Thyatron



Max. Dimen.:  
Ht. 9-1/2"  
Diam. 3-3/16"

Ratings:  
E<sub>f</sub> 2.5 volts  
I<sub>f</sub> 16.0 amps.  
e<sub>px</sub> 350 volts  
I<sub>o</sub> 4.0 amps.  
I<sub>b</sub> 16.0 amps.

Atmosphere:  
Argon-Mercury

### Type 354A

Thyatron



Max. Dimen.:  
Ht. 9-1/2"  
Diam. 2-5/16"

Ratings:  
E<sub>f</sub> 2.5 volts  
I<sub>f</sub> 16.0 amps.  
e<sub>px</sub> 1500 volts  
I<sub>o</sub> 4.0 amps.  
I<sub>b</sub> 16.0 amps.

Atmosphere:  
Mercury Vapor

### Type 575A

Rectifier



Max. Dimen.:  
Ht. 11-1/16"  
Diam. 3-1/16"

Ratings:  
E<sub>f</sub> 5.0 volts  
I<sub>f</sub> 10.0 amps.  
e<sub>px</sub> 15 KV  
I<sub>o</sub> 1.5 amps.  
I<sub>b</sub> 6.0 amps.

Atmosphere:  
Mercury Vapor

UNITED



ELECTRONICS, 42 Spring Street, Newark 2, N. J.

(TRANSMITTING TUBES EXCLUSIVELY Since 1934)





## MOSINEE plants fibres for industry

In Mosinee Industrial Forests, seedlings by the thousands are being planted annually to replace the trees used for products of industry, assuring future supply of fibres vital to many products.

Also, on privately-owned acreage, Mosinee supplies the seedlings and know-how to convert otherwise waste land to fibre-producing forests for the future.

This reforestation is the first step in the process of making Mosinee Fibres that work for industry.



MOSINEE PAPER MILLS CO.  
MOSINEE, WISCONSIN

**MOSINEE**  
makes fibres work for industry

military applications are: high ambient temperature operation, climatic protection and reduction in size.

Signal Corps equipment must meet full operational requirements at 55 C and, in addition, must be operable at 71 C after sustained storage at 74 C. Present selenium rectifier ratings are based on an ambient temperature of 35 C, which is the ambient operating temperature of most commercial equipment. For operations at temperatures above 35 C the rectifier has to be derated for voltage and/or current at 55 C. Therefore, a larger size unit must be used to prevent overheating and damage to the rectifier. Recently, an announcement was made by a manufacturer that selenium rectifier plates are being produced which can be operated at 120 C. This claim is based on the use of a higher melting point alloy for the counter electrode and a modified heat treatment process.

### *New Coatings*

It can be readily understood that a sealed unit for operation at 55 C and high humidity is appreciably larger than a unit of the same electrical output for operation at 35 C and ambient humidity. Government Laboratories are presently investigating both the possibility of replacing oil with other fluids, to effect a reduction in size and weight, and the development of coatings to withstand severe climatic conditions.

The prime effort of industry is directed toward the development of more suitable coating materials. Development of a new coating for selenium rectifiers is a complex and time-consuming project, because of the numerous problems involved, the most important of which are: the forward resistance of the rectifier should not increase with application of coating material; the reverse resistance should not decrease with application of coating; because of the inherent characteristics of selenium rectifiers, the curing or baking temperature for the coating should be limited to below 100 C; and the coating should be chemically compatible with any approved moisture- and fungus-proofing varnishes and lacquers

*A New Concept in Precision Potentiometers . . .*

## THE MODEL J Helipot

Precise Mechanical Concentricity

High Electrical Accuracy

Ball Bearing Construction

Independent Phasing

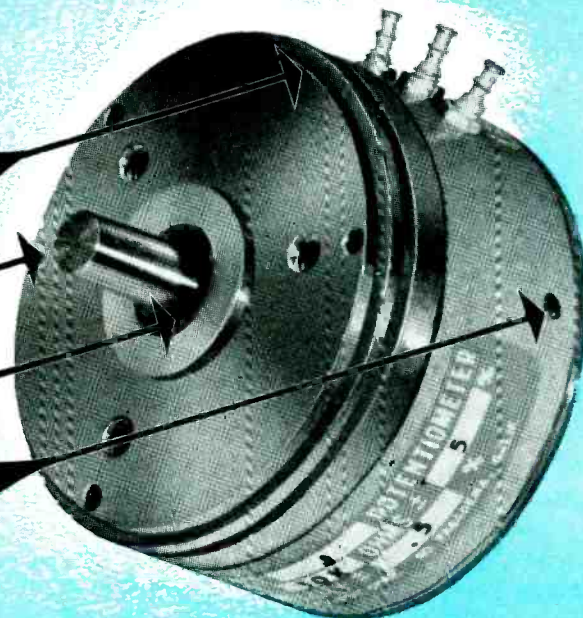

*. . . combined with mass-production economies!*

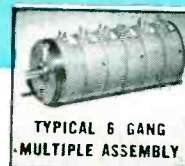

*If it's a tough potentiometer problem, bring it to Helipot*

—for Helipot has facilities and know-how unequalled in the industry for mass-producing precision potentiometers with advanced operating and electrical features.

This recently-developed 'Model J' Helipot, for example, combines several revolutionary advancements never before available in the potentiometer field . . .

### Precise Mechanical Concentricity

Modern servo mechanisms and computer hook-ups require high mechanical precision to insure uniform accuracy when connected to servo motors through close-tolerance gears and couplings.

In the "Model J," close concentricity between mounting surface and shaft is assured by a unique mounting arrangement. The unit can be aligned on either of two wide-base flange registers and secured with three screws from the front of the panel . . . or it can be secured with adjustable clamps from the rear of the panel to permit angular phasing. Or if preferred, it can be equipped with the conventional single-hole bushing type of mounting.

In addition to accurate mounting alignment, exact rotational alignment is assured by the long-life, precision-type ball bearings upon which the shaft rotates. Precise initial alignment coupled with negligible wear mean high sustained accuracy.

### High Electrical Accuracy

Helipot products have long been noted for their unusually high electrical accuracy and the "Model J" embodies the latest advancements of Helipot engineering in this field.

For example, tap connections are made by a new Helipot welding technique whereby

the tap is connected to only ONE turn of the resistance winding. This unique process eliminates "shorted section" problems!

High linearity is also assured by Helipot's advanced production methods. Standard "Model J" linearity accuracies are guaranteed within  $\pm 0.5\%$ . On special order, accuracies to  $\pm 0.15\%$  (capacities of 5000 ohms and up) have been obtained.

### Ball Bearing Construction

The shaft of each "Model J" is carefully mounted on precision-type ball bearings that not only assure sustained rotational accuracy, but also provide the constant low-torque operation so essential for servo and computer applications. Starting torque is only  $\frac{3}{4}$  of an inch-ounce ( $\pm .25$  in. oz.)—running torque, of course, is even less.

### Independent Phasing

When using the "Model J" in ganged multiple assemblies, each section can be independently phased electrically or mechanically—even after installation on the panel—by means of hidden internal clamps controlled from outside the housing. Phasing is simple, quick, accurate!

### Mass-Production Economies

In addition to its many other unique features, Helipot engineers have developed unusual techniques that permit mass-production economies in manufacturing the "Model J". Actual price depends upon the number of taps required, special features, etc. . . . but with all its unique features, you will find the "Model J" very moderate in cost.\*

### Wide Choice of Designs

The "Model J" Helipot is available in a wide selection of standard resistance ranges—50, 100, 1,000, 5,000, 10,000, 20,000, 30,000 and 50,000 ohms . . . in single- or double-shaft designs . . . with choice of many special features to meet virtually any requirement within its operating field.

\*Write for Bulletin 107 which gives complete data and price information on the versatile "Model J" Helipot!

**THE Helipot CORPORATION**  
South Pasadena 2, California

Field Offices: Boston, New York, Philadelphia, Rochester, Cleveland, Detroit, Chicago, St. Louis, Los Angeles and Fort Myers, Florida. Export Agents: Fratham Co., New York 13, New York.



## Sensational New NYLON Lacing Cords win approval of "Big Name" Companies\*

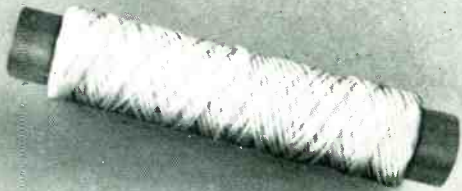

\* names on request

"Never anything like it before", say the big companies in the electronics field. They're referring to Heminway & Bartlett's new fungus-proof Nylon Lacing Cords, specially coated to resist mold and micro-organisms and at the same time retain malleability.

With a tensile strength to suit your particular problem, and a synthetic resin finish with a melting point of over 190°, these new cords meet every installation requirement.

We'll be glad to give you complete information, including samples for field testing. No obligation, of course.

THE HEMINWAY & BARTLETT MFG. CO., 500 Fifth Avenue,  
New York 18, New York. Branches: Chicago, Ill., St. Louis,  
Mo., Cincinnati, Ohio, Charlotte, N. C., Gloversville, N. Y.

### HEMINWAY & BARTLETT

FUNGUS-PROOF

*Nylon Lacing Cords*

## Unless the Dry Battery You Need Is Listed in This Free Manual...



**BURGESS  
ENGINEERING  
MANUAL**

### BURGESS ENGINEERS WILL DESIGN A NEW BATTERY TO MEET YOUR SPECIFICATIONS

It's all part of the Burgess Service! This complete Engineering Manual lists *hundreds* of battery types developed by Burgess Engineers to meet new requirements. If the specific battery you need is not among them, the complete Burgess facilities, design, production, and engineering will be placed at your disposal to build the battery you need in any quantity—large or small!

**Write for ENGINEERING MANUAL and CHECK SHEET**

No obligation. By return mail you will receive the FREE Engineering Manual listing the complete line of Burgess Batteries together with specifications; also the Burgess "Check Sheet" on which you may outline your requirements in the event that the battery you need has not already been developed. Address:



## BURGESS BATTERY COMPANY

(DEPT. E1) FREEPORT, ILLINOIS

## Top-Flight Business Leaders

### SHIP TODAY

### VIA TWA



TWA's new, fast, all-cargo "Sky Merchant" Fleet speeds your shipments to important markets in U. S. and overseas.

Experienced shippers know the smartest way to ship is via dependable TWA All-cargo "Sky Merchants."

Direct routes and connections serve more than 60 important market centers in the U. S. All-cargo flights overseas every week end, as well as frequent flights direct to London, Frankfurt, Paris, Zurich, Geneva, Milan, Rome.

### Check these outstanding advantages:

1. Save shipping time.
2. Obtain faster, wider distribution.
3. Replenish stocks practically overnight.
4. Reduce risk of pilferage, damage, loss.
5. Save costs on crating and insurance.
6. Receive careful, dependable handling of all shipments by TWA cargo specialists.
7. And remember, TWA service meets the urgency of every emergency.

Make a memo—NOW—to phone TWA (Trans World Airlines) for information, rates, schedules, quick pick-up service. Request interesting folder from Cargo Sales Manager, TWA, 60 East 42nd Street, New York 17, N. Y.



All TWA flights carry  
Air Mail and Air  
Cargo.

# TWA

TRANS WORLD AIRLINES

U.S.A. • EUROPE • AFRICA • ASIA



# Master Pieces of Hermetic Sealing —Proven to Reduce Rejects!

**PLUG IN TYPE HEADERS**

OC-8  
16 CHARACTERS  
.093 D. PIN  
.050 I.D.  
FLASH OVER VOLTAGE  
6000V PIN TO RIM

OC-12  
16 CHARACTERS  
.0330 PIN  
.030 I.D.  
6500V PIN TO RIM

**MULTIPLE TYPE HEADERS**

1000 SERIES AVAILABLE  
WITH 2 TO 10 TERMINALS

2000 SERIES AVAILABLE  
WITH 2 TO 6 TERMINALS

FLASH OVER VOLTAGE  
6500V PIN TO RIM

6500V PIN TO RIM

**NEO-SIL HERMETIC SEALS  
INDIVIDUAL TYPE TERMINALS**

E-1  
FLASH OVER  
VOLTAGE  
2500V

E-3  
FLASH OVER  
VOLTAGE  
5500V

E-4  
FLASH OVER  
VOLTAGE  
5530V

**TEST DATA**

The result of the Electrical Testing Laboratories Inc., Report #330655, dated March 18, 1949, on this material shows the following:

Volume Resistivity at 800 Volts d-c  
Room Temperature 25°C R.H. 30 percent  
Megohm-inches  $1.4 \times 10^6$  ohm-centimeters  $3.5 \times 10^{12}$

**Dielectric Constant and Dissipation Factor**

Dielectric Constant	Dissipation Factor	Loss Factor
9.22 @ 60 cycles per second	.058	5.32
6.17 @ 1 megacycle per second	.0455	.28
5.35 @ 50 megacycles per second	0.20	1.1

Dielectric Strength at 60 cycles  
Volts per mil — 370

Durometer Average —  $80 \pm 5$   
Temperature — Rated as a Class A material conservatively + 105° to -70° centigrade.

The Flashover Voltages indicated were taken at a temperature of 68° Fahrenheit, and 47% Relative Humidity.

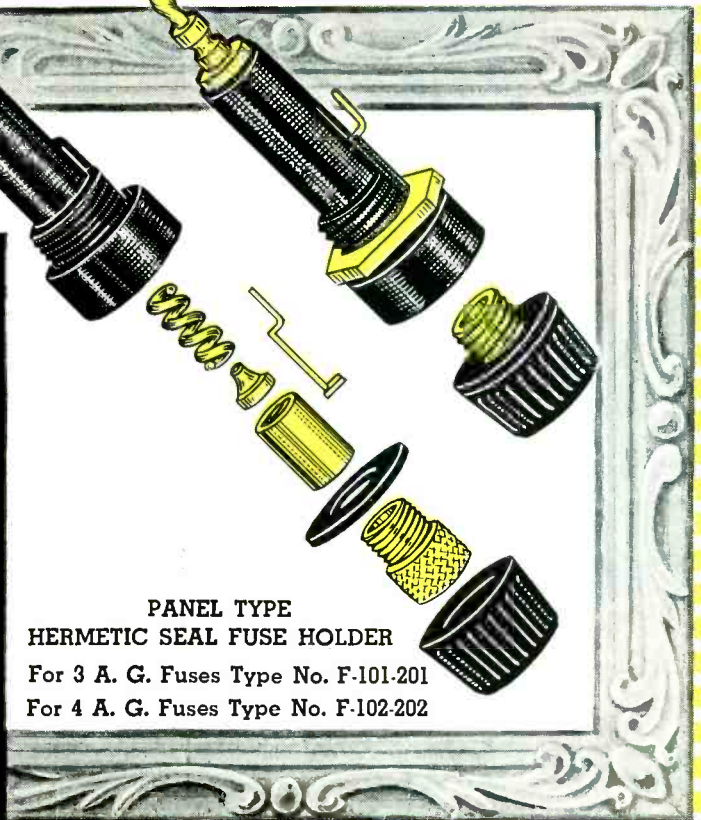

**PANEL TYPE  
HERMETIC SEAL FUSE HOLDER**  
For 3 A. G. Fuses Type No. F-101-201  
For 4 A. G. Fuses Type No. F-102-202

NEO-SIL proven dependable Hermetic sealing components will reduce your rejects resulting from breakage, strain, cracks, physical shocks, etc. Each NEO-SIL component is pressure checked at 25 lbs. P.S.I. —to meet military requirements. As a unit, NEO-SIL synthetic compound is suitable insulation when bonded to various metals to resist abusive temperature cycling, salt water, high pressure, high vacuum and most acids and alkalis.

In addition to the Panel Type Hermetic Seal Fuse Holder illustrated, NEO-SIL offers many other specialty components: Molded Cable with plugs attached—4 Pin Female Panel Connector—Meter Hermetic Seal Gasket—5 Pin Female Panel Connector—Rotary Hermetically Sealing Panel Bushing.

Your special problems are solicited.



26 CORNELISON AVE., JERSEY CITY 4, N. J.



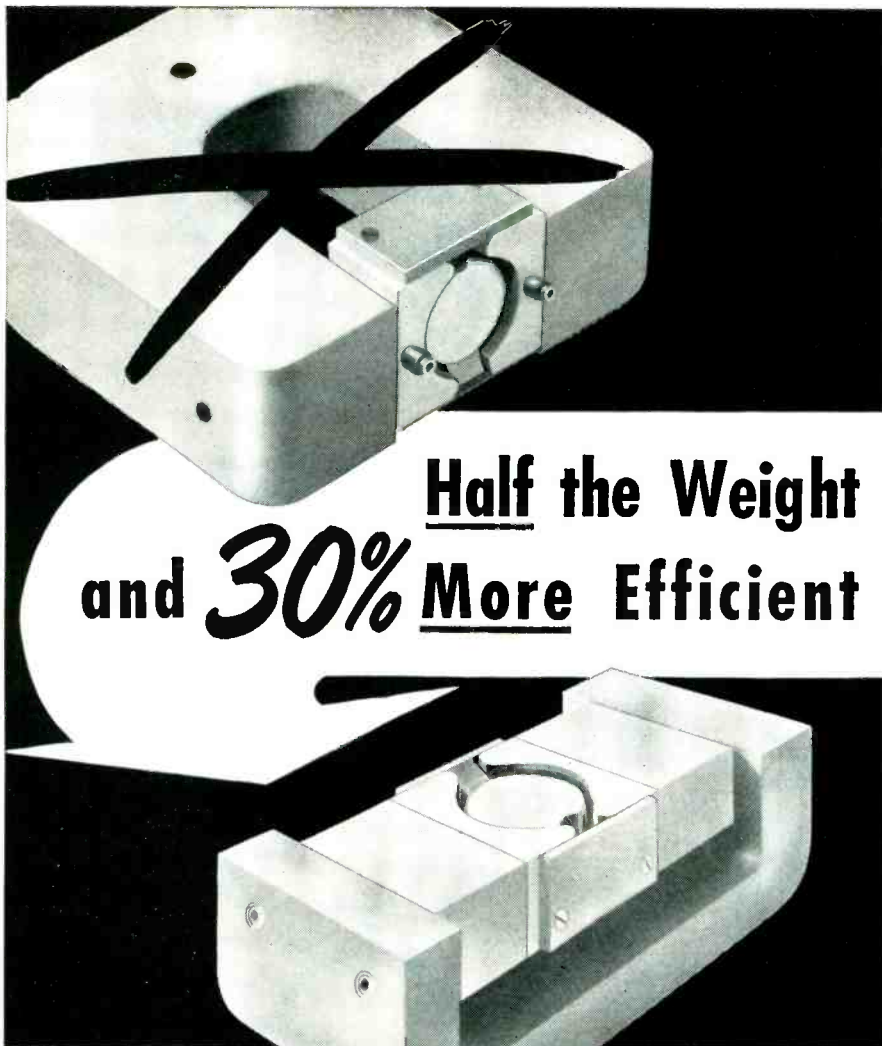

**Half the Weight  
and 30% More Efficient**

Before Thomas and Skinner Engineers were called in by Associated Research, Inc., to redesign the permanent magnet assembly for the Keeler Polygraph, commonly called the "lie detector," the magnetic unit weighed a total of 5.57 pounds.

After redesigning, the unit weighed only 2.93 pounds—with the bonus of 30% more gauss in the air gap.

The compact, weight-saving unit engineered by Thomas and Skinner consists of .58 of Alnico V, 1.82 pounds of iron circuit and 0.47 pounds of pole pieces . . .

compared with the old assembly of 5.10 pounds of Alnico I and 0.47 pounds of pole pieces.

This material saving, space saving application is typical of the permanent magnets designed by Thomas and Skinner. Behind every recommendation is the accumulated experience of 50 years of specialization in problems of this type—a half century of designing, engineering and producing magnetic units.

Call in Thomas and Skinner for a review of your permanent magnet applications.

*Specialists in magnetics: permanent magnets and laminated cores*



**THOMAS & SKINNER Steel Products Company**  
1120 East 23rd Street • Indianapolis, Indiana

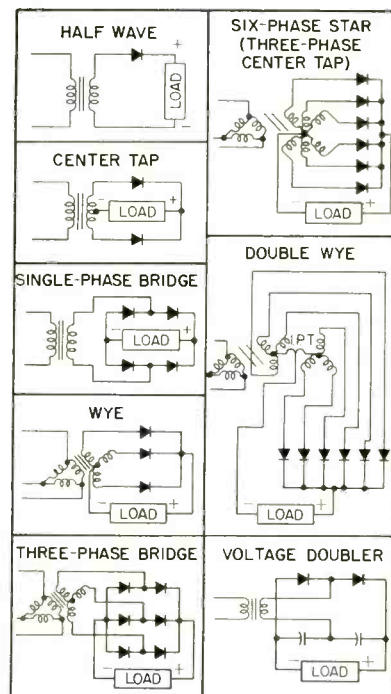

Typical selenium rectifier circuit applications

which may be applied to equipments in normal moisture- and fungus-proofing treatments.

The coating must withstand ten cycles of the Standard Moisture Resistance Test for Component Parts, and must not peel, flake, blister or show any signs of damage. Announcement has been made recently of the development of some new coatings which are currently being evaluated at the Signal Corps Engineering Laboratories.

*Size Reduction*

The reduction of the size of rectifiers has been limited by the voltage rating of each plate. The first selenium rectifier plates produced commercially were limited to a maximum inverse voltage rating of 14 volts. Development of better barrier layers led to a rating of 18 volts per plate. Post-war work by most of the manufacturers resulted in the development of 26-volt plates with manufacturers currently claiming development of a 33-volt and a 40-volt plate. The 26-volt plates have been evaluated by the Signal Corps Engineering Laboratories and are currently being used in the design of new equipment.

Considerable development work is being performed by industry under government laboratory contracts on selenium rectifiers leading toward

NOW FOR THE FIRST TIME

IN TV—

1 kw AT 900 mc

PLUS  
CERAMIC  
CONSTRUCTION



**NEW**  
**GL-6019**

See this great new G-E power tetrode at the I.R.E. Show in New York, March 19 to 22. Or wire or write for descriptive folder ETD-152. *Electronics Department, General Electric Company, Schenectady 5, New York.*

GENERAL  ELECTRIC

185-K3



# DO YOU KNOW?

— that a **PILOT LIGHT**  
CAN IMPROVE YOUR PRODUCT  
. . . . add attraction — safety — service?

Ask **DIALCO**

- what lamp to use
- how to use it
- what it will do
- what it will cost

**THIS MAY BE THE ONE**  
Designed for low cost NE-51 Neon

- Built-in Resistor • Patented
- U/L Listed • Rugged

Catalogue Number 521308 — 997  
for 110 or 220 volts.

### SAMPLES

for design purpose  
**NO CHARGE**

**NEW!** Write for the  
"HANDBOOK OF PILOT LIGHTS."

Write us on your design problems.



**The DIAL LIGHT COMPANY of AMERICA**

Foremost Manufacturer of Pilot Lights.

900 BROADWAY, NEW YORK 3, N. Y. TELEPHONE SPRING 7-1300

## new! 1951 ALLIED CATALOG

**free!**  
212-Page  
Buying  
Guide

World's Largest Stocks  
**ELECTRONIC SUPPLIES**  
for **INDUSTRY** and  
**BROADCAST STATIONS**



### One Complete Dependable Source for Everything in Electronics

Simplify your purchasing—send your consolidated orders to ALLIED—the single, complete source for all Electronic Supplies. Depend on ALLIED for the world's largest stocks of special tubes, parts, test instruments, audio equipment, accessories—complete quality lines of electronic supplies. Our expert Industrial supply service saves you time, effort and money. Send today for your FREE copy of the 1951 ALLIED Catalog—the only complete, up-to-date guide to Electronic Supplies for Industrial and Broadcast use.

**ALLIED RADIO CORP.**

833 W. Jackson Blvd., Dept. 11-C-1, Chicago 7, Illinois

We Specialize in Electronic  
Equipment for Research,  
Development, Maintenance  
and Production Operations

**SEND FOR  
FREE 1951  
ALLIED CATALOG**

**Spincraft**  
SKILL WILL DO IT®

provides  
**a low cost source**

for the  
**Production of  
Electronic Parts**

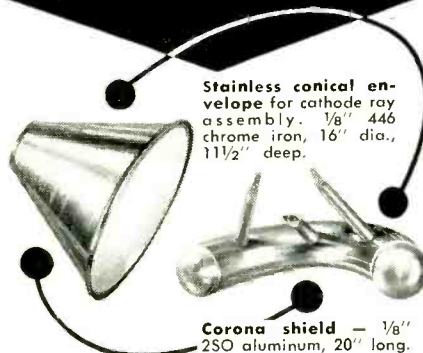

Stainless conical envelope for cathode ray assembly. 1/8" 446 chrome iron, 16" dia., 11 1/2" deep.

Corona shield — 1/8" 250 aluminum, 20" long.



Rectangular TV envelope — mass produced of 1/8" 430 chrome iron, 24" wide, 16" high, 9" deep.

Beaded static shield — 18 U. S. ga. cold rolled steel, 8" dia.

**STUDY** these illustrations of Spincraft "engineering" — interesting examples of a high order of ability to "work" metal by spinning and fabricating. Best of all, these methods pay off in time gained — and substantially lower costs, both on large and small runs.

Progressive new Spincraft techniques may help simplify your production problem in any metal — just as they have helped others in the electronics industry. Your inquiry is welcome — and you are invited to send for the new Spincraft Data Book, a stimulating source of ideas for engineers, designers and plant production men. Write today.

**Spincraft**  
SKILL WILL DO IT®  
INCORPORATED

4143 W. State St. Milwaukee 8, Wis.  
Heretofore known as  
Milwaukee Metal Spinning Co.

# FERRAMIC

## cores by GENERAL CERAMICS

Ferramics are soft magnetic materials featuring:

- HIGH PERMEABILITY**
- HIGH VOLUME RESISTIVITY**
- HIGH EFFICIENCY**
- LIGHT WEIGHT**
- ELIMINATE LAMINATIONS**



T Y P E O F F E R R A M I C M A T E R I A L

PROPERTY	UNIT	A 34	B 90	C 159	D 216	E 174	G 254	H 419	I 141	J 472
Initial permeability at 1mc/sec	—	15	95	220	410	750	410	850	600	330
Maximum permeability	—	97	183	710	1030	1710	3300	4300	1010	750
Saturation flux density	Gauss	840	1900	3800	3100	3800	3200	3400	1540	2900
Residual magnetism	Gauss	615	830	2700	1320	1950	1050	1470	660	1600
Coercive force	Oersted	3.7	3.0	2.1	1.0	0.65	0.25	0.18	0.41	.80
Temperature coefficient of initial permeability	%/°C.	0.65	0.04	0.4	0.3	0.25	1.3	0.66	0.3	0.22
Curie point	°C.	280	260	330	165	160	160	150	73	180
Volume resistivity	Ohm-cm	1x10 <sup>9</sup>	2x10 <sup>5</sup>	2x10 <sup>3</sup>	3x10 <sup>7</sup>	4x10 <sup>5</sup>	1.5x10 <sup>8</sup>	1x10 <sup>4</sup>	2x10 <sup>5</sup>	—
Loss Factor:										
at 1 mc/sec	—	—	.00016	.00007	.00005	.00008	.00008	.00030	.0033	.000055
at 5 mc/sec	—	.0004	.0011	.0008	.0012	.002	.00075	.00155	.005	—
at 10 mc/sec	—	.0005	—	—	—	—	.0017	.00275	—	—

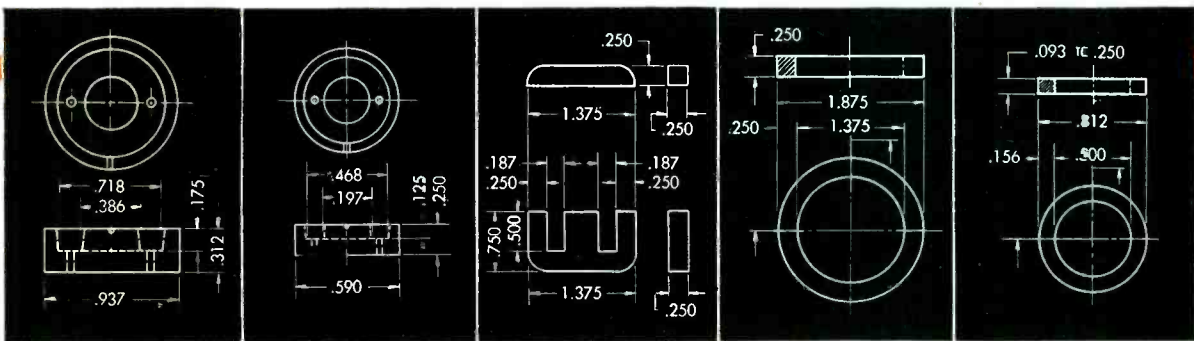

BOOTH 47  
at the  
IRE SHOW

**General CERAMICS AND STEATITE CORP.**  
GENERAL OFFICES and PLANT: KEASBEY, NEW JERSEY

MAKERS OF STEATITE, TITANATES, ZIRCON PORCELAIN, FERRAMICS, LIGHT DUTY REFRACTORIES, CHEMICAL STONEWARE, IMPERVIOUS GRAPHITE



# PRECISION FREQUENCIES

**ACCURACY: 1 PART IN 100,000 (OR BETTER) .001%**

**FOR USE IN  
SUCH FIELDS AS**

AVIATION  
ASTRONOMY  
BALLISTICS  
HIGH-SPEED PHOTOGRAPHY  
VISCOSITY MEASUREMENT  
NUCLEAR PHYSICS  
TELEMETERING  
RADIATION COUNTING  
FLUID FLOW  
CHEMICAL REACTION  
NAVIGATION  
SCHOOL LABORATORIES  
INDUSTRIAL RESEARCH LABS.  
ACCURATE SPEED CONTROL

The controlling unit of these frequency standards is a bi-me-allic fork, temperature-compensated and hermetically sealed against humidity and variations in barometric pressure. When combined with related equipment, accurate speed and time controls are afforded by mechanical, electrical, acoustical or optical means.

Instruments of our manufacture are used extensively by industry and government departments on such precision work as bomb sights and fire control.

Whatever your frequency problems may be, our engineers are ready to cooperate.

*When requesting further details, please specify the Type Numbers on which information is desired.*

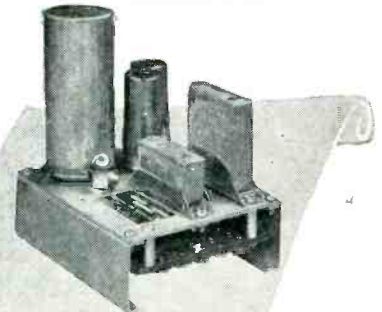

**TYPE 2001-2. BASIC UNIT**

Frequencies, 200 to 1500 cycles.  
Dividers and Multipliers available for lower and higher frequencies.  
Miniaturized and JAN construction.  
Output, 6 volts.

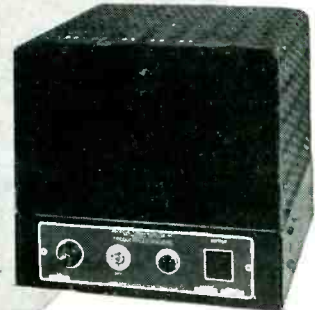

**TYPE 2005. UTILITY UNIT**

consists of Type 2001-2 and booster to provide 10 watts at 110 V at 60 cyc. Input, 50-100 cyc.



**TYPE 2121A. LAB. STANDARD**

Outputs, 60 cycle, 0-110 Volts.  
120-240 cycle impulses.  
Input, 50-400 cycles, 45 W.

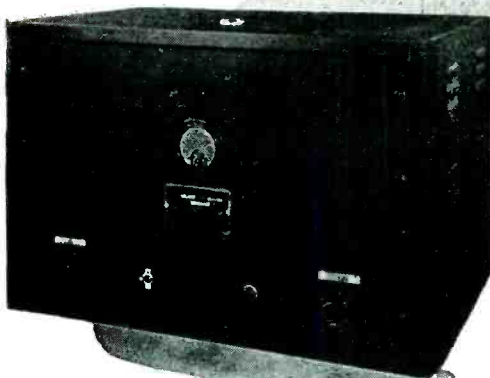

**TYPE 2111. POWER UNIT**

50 W output, 0-110 V at 60 cyc.  
Input, 50-100 cyc., 275 W.

**American Time Products, Inc.**  
580 Fifth Avenue  
New York 19, N. Y.

OPERATING UNDER PATENTS OF THE WESTERN ELECTRIC COMPANY

higher voltage plates, higher temperature plates, and improved coatings, including the various thermoplastics and casting resins. In addition, extensive basic research work on semiconductors is being performed at various universities for the laboratories of the Government, in the hope that development of a proved theory of operation will lead to a design and production of better semiconductors.

### Emergency Wire-Line To Radio Circuits

BY  
LIEUTENANT COLONEL DAVID TALLEY  
*Signal Corps  
United States Army Reserve*

TO PROVIDE direct person-to-person conversations between responsible personnel during emergency conditions, temporary interconnecting of wire lines to radio channels may be required until wire circuits are restored. This article describes briefly the construction and operation of a simplified four-wire radio, two-wire telephone termination set for such operation.

Circuits and apparatus described are based on standard commercial practices and design considerations. With proper audio-gain adjustments, speech levels should conform to wire-line transmission requirements providing there is no excessive interference.

Radio circuits are four-wire circuits, two wires to the transmitter input and two from the receiver output, and are essentially one-way devices. The telephone network operates on a two-wire basis and, in order that radio be used as an extension of the wire network, it is necessary to match the four-wire radio network into the two-wire telephone line.

If the radio circuit is operated on a push-to-talk or simplex basis, the connection may be made easily. Figure 1 illustrates one suggested method for a telephone line connection for simplex operation. It is desirable for transmission purposes that the radio receiver's output and the radio transmitter's in-

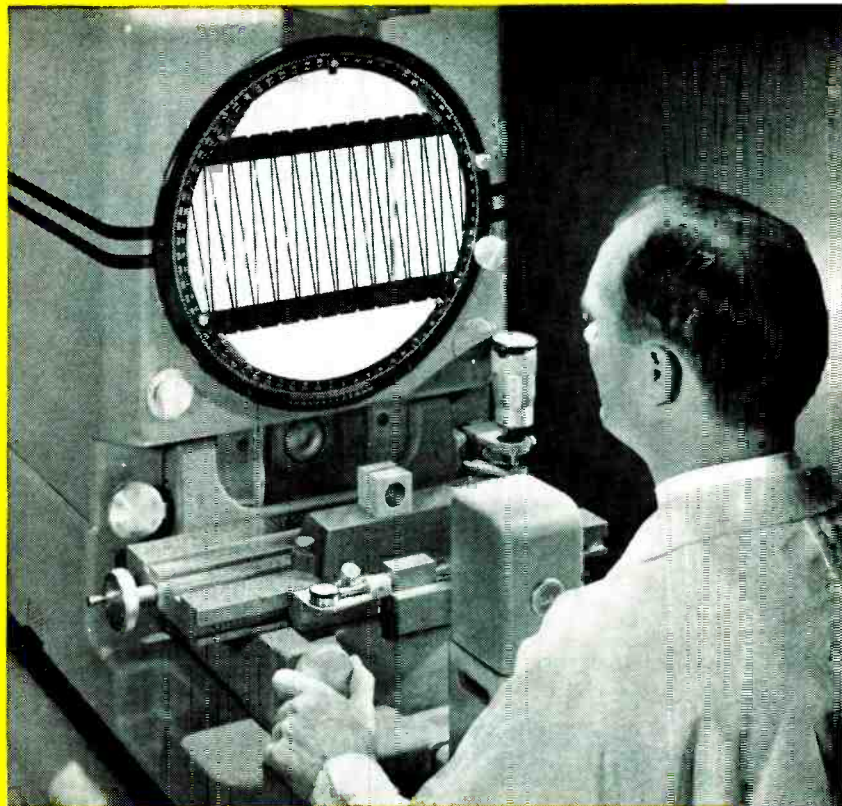

## WANT A REPUTATION FOR PRECISION? Inspect Your Parts Magnified on a Bright Screen

The Kodak Contour Projector, Model 2, has unique features that permit efficient staging fixtures to keep inspection costs low and inspection standards high.

There's a full eight inches between lens and object, unchanging for any of six quickly dialed magnifications up to 100X—all comfortably visible in a lighted room on an uncurtained 14" screen. You can put the object in any of five planes: vertical, horizontal downward, at left of lens, at right, or atop a glass table. And, just by flipping a switch, you get illumination through the projection lens itself to show surface detail and explore deep recesses.

For complete details about this versatile projection microscope and its measuring accessories, just send in the coupon.

### the KODAK CONTOUR PROJECTOR

shows contours, of course...  
surface details... deep recesses



**EASTMAN KODAK COMPANY**  
Industrial Optical Sales Division  
Rochester 4, N. Y.

48

Please send your booklet on the Kodak Contour Projector.

NAME \_\_\_\_\_ (Please print)

COMPANY \_\_\_\_\_

ADDRESS \_\_\_\_\_

CITY \_\_\_\_\_ ZONE \_\_\_\_\_

STATE \_\_\_\_\_

**Kodak**  
TRADE-MARK



here's your ANSWER to the  
**colored wire shortage!**



**E-Z CODE WIRE MARKERS** simplify the assembly of wiring circuits by number or standard NEMA color code—answer problems created by a colored wire shortage. They maintain accuracy...minimize rejections...simplify inspection...and get the most from new, inexperienced employees, even when assigned to the most complicated wiring projects. E-Z Codes, with the exclusive Speed-Tab, are faster to remove from carrying card, quicker to apply (*without moistening*) and adhere permanently to wire and cable, even when pulled through conduit. They are unaffected by heat and humidity. E-Z Codes are the efficient, low-cost answer to your colored wire shortage problem.

WRITE FOR SAMPLES TODAY!



600 East Second Street  
 Los Angeles 54, Calif., Dept. E-2  
 740 Luckystone Avenue  
 St. Louis 22, Mo.  
 Rocket Distributors, Bayside, L. I., N. Y.

**A  
G  
A  
S  
T  
A  
T**  
 TYPE 1

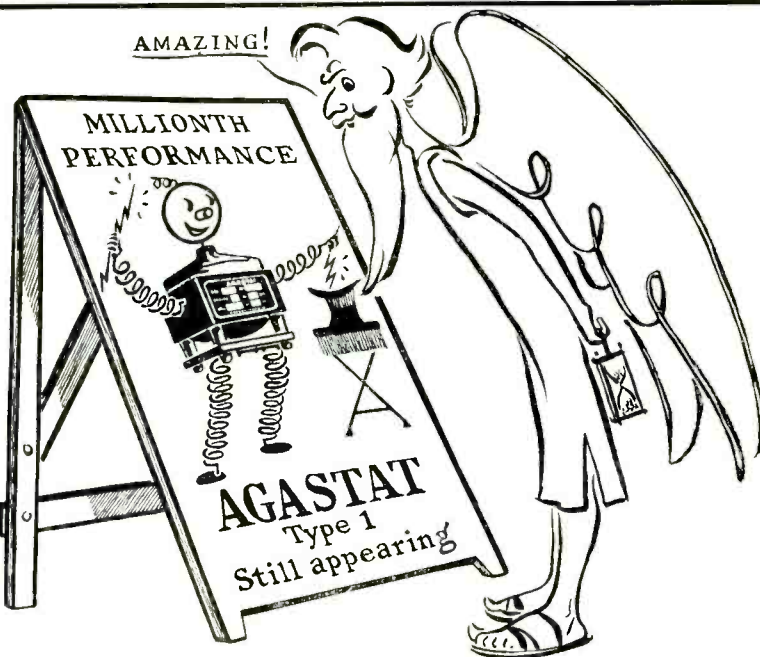

TIME DELAY STARTS WHEN COIL IS ENERGIZED. For continuous duty for both AC and DC service. Small, compact, well-designed. Literature on request.



**AMERICAN GAS ACCUMULATOR COMPANY**  
 1027 NEWARK AVENUE • ELIZABETH 3, N. J.

**HICKOK**

*Laboratory*  
**MODEL**  
**TUBE TESTER**

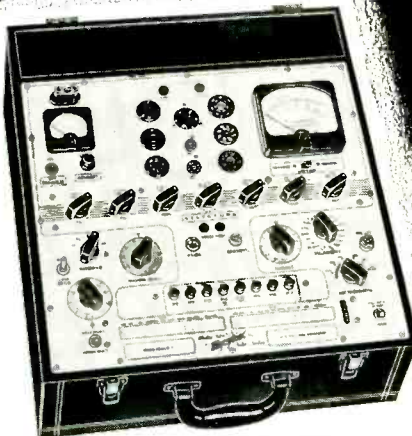

MODEL 539

*Especially Accurate*

- Dynamic Mutual Conductance . . . Readings in Micromhos.
- Permits choice of 3 A.C. signals, .25, .5, and 2.5 volts.
- Vernier adjustment permits accurate setting of grid voltage.
- Optional self-bias arrangement.
- Provision for insertion of plate milliammeter for measuring plate current.
- Separate A.C. meter measures line voltage at all times.
- D.C. grid bias and D.C. plate and screen voltages.
- Tube life and gas test for accurate matching of tubes.
- Tests all tubes normally encountered in all phases of electronic work.
- Designed with professional accuracy for engineers and engineering technicians.

See the Model 539 at your jobbers or write for additional information today!

**The HICKOK ELECTRICAL INSTRUMENT COMPANY**

10527 Dupont Ave., Cleveland 8, O.

*Our 40th Anniversary*

*R*adios are different now



...and in this era of engineering progress  
**MODERN ELECTRONICS LOOK TO HI-Q\***  
 Capacitors • Trimmers • Choke Coils • Wire Wound Resistors

● No science has grown faster or gone farther than electronics since those first amazing crystal receivers picked words and music out of the air. And in the development of modern radio, TV, communications and other electronic equipment, one of the prime contributions to dependability, long life and compactness has come from the use of ceramic components as perfected by **Hi-Q**.

Though **Hi-Q** output in four plants is now at the rate of several million units a month, there is no variation in the quality or high performance characteristics of its capacitors, trimmers, choke coils and wire wound resistors. Engineering watchfulness and rigid production control insure the maintenance of uniform precision standards well within the limits of minute tolerances. And it has become an industry maxim that in the development of special components to meet unusual requirements, **Hi-Q** engineers are the most competent and resourceful in their field. Their services are available to your organization in helping solve any problems you may have.

JOBBERS — ADDRESS: 740 Belleville Ave., New Bedford, Mass.

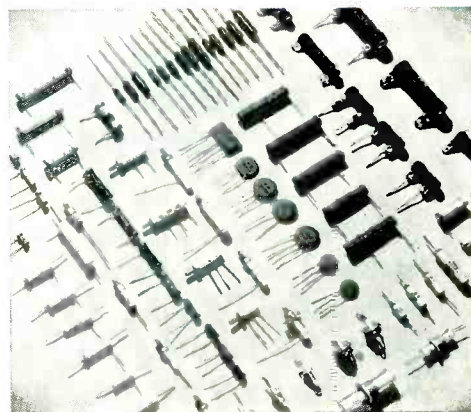

**BETTER 4 WAYS**

- ✓ PRECISION
- ✓ UNIFORMITY
- ✓ DEPENDABILITY
- ✓ MINIATURIZATION



\* Trade Mark Registered, U. S. Patent Office

*Electrical Reactance Corp.*  
 OLEAN, N. Y.

SALES OFFICES: New York, Philadelphia, Detroit, Chicago, Los Angeles

PLANTS: Olean, N. Y., Franklinville, N. Y. Jessup, Pa., Myrtle Beach, S. C.



# ALTEC amplifiers...

...perform



...and perform

and perform



...without failure!

Especially now, when material shortages may make replacement parts impossible to find, dependable Altec quality pays extra dividends. Equipment failures can mean the loss of thousands of dollars. Altec superiority, in engineering, large safety factors, conservative ratings and the use of quality components, is the best possible insurance against these costly breakdowns. Invest wisely. Buy the amplifiers that give the greatest value. Buy Altec amplifiers. They perform... and perform... and perform.

9356 Santa Monica Blvd., Beverly Hills, Calif.  
161 Sixth Avenue, New York 13, New York

**ALTEC**  
LANSING CORPORATION

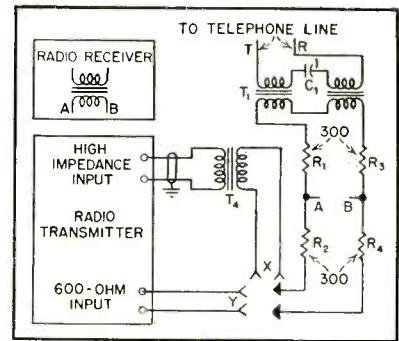

FIG. 1—Telephone line connection for simplex or push-to-talk manual switching facilities

put have terminal impedances of 500 or 600 ohms in order to match the telephone line.

In Fig. 1, the 300-ohm resistances,  $R_1$ ,  $R_2$ ,  $R_3$  and  $R_4$ , form a dividing network. During reception, the audio output of the radio receiver is divided approximately equally between the input circuit of the radio transmitter and the winding of repeating coil  $T_1$ . The audio power in the transmitter's input is lost as the radio transmitter is inoperative. This audio loss is unimportant because the average communication receiver has output to provide more than enough audio to the telephone line including this 3-db loss.

When the transmitter is in operation, the input from the telephone line divides equally between the transmitter's input and the receiver's output circuit. The speech level from the telephone line should be sufficient to fully modulate the radio transmitter with normal gain adjustments. It may be necessary, however, to "ride the gain" to compensate for varying speech levels from the telephone line during the conversation period.

#### Full Duplex Method

Occasions may arise where the use of full duplex operations would be advantageous. This type of operation requires that the radio transmitter and receiver be connected to the telephone line in such a manner as to permit simultaneous conversations without switching the transmitter on and off. This method may be employed, for example, on the 2- and 11-meter bands where unmodulated carrier emissions are authorized. It also can be

# Know Your Plastics

**FOR ELECTRICAL INSULATION PARTS REQUIRING**

**Low Power Factor**

**Low Loss Factor**

**High Resistivity**

**Dimensional Stability**

**Low Water Absorption**

**Choose BAKELITE "Low-Loss" Phenolic Molding Materials**

The BAKELITE line of plastics contains a group of Phenolic materials developed expressly for difficult electrical insulating jobs. These superior materials offer custom molders and product designers the needed properties, electrical and mechanical, for communications equipment, marine electrical parts, and automotive applications.

## RANGES OF VALUES FROM ELECTRICAL TESTS

Dielectric Strength (D149-44) S/T 1/8", volts/mil	300-400
Dielectric Strength (D149-44) S/S 1/8", volts/mil	250-350
Volume Resistivity (D257-46), meg.-cms.	10 <sup>6</sup> -10 <sup>8</sup>
Dielectric Constant (D150-47T)	
60 cycles	4.8-6.5
1,000 cycles	4.6-5.5
1,000,000 cycles	4.5-5.2
Power Factor (D150-47T)	
60 cycles	0.01-0.07
1,000 cycles	0.006-0.05
1,000,000 cycles	0.005-0.02
Loss Factor (D150-47T)	
60 cycles	0.05-0.46
1,000 cycles	0.03-0.28
1,000,000 cycles	0.02-0.10

## RANGES OF VALUES FROM MECHANICAL TESTS

Compressive Strength (D695-44), 15,000 to 24,000 psi. Tensile Strength (D651-48) (1/8"), 5,000 to 7,000 psi. Flexural Strength (D790-45T), 9,000 to 12,000 psi. Modulus of Elasticity in Flexure (D790-45T), 25-35 x 10<sup>5</sup> psi.

## RANGES OF VALUES FROM MISCELLANEOUS TESTS

Other property ranges of BAKELITE "Low Loss" Phenolics are as follows: Molded specific gravity, 1.66 to 1.92; thermal coefficient of expansion, linear per deg. C. (D696-44), 2 x 10<sup>-5</sup>; heat distortion temperature (D648-45T), 230-350 deg. F.; water absorption (D570-42), per cent gain in weight, 0.01-0.07.

Address inquiries to Dept. BR-47.

### BM-262 NATURAL "LOW LOSS" MATERIAL

Properly molded, it is the top quality low-loss phenolic. Requires greater care in molding than other low-loss materials. Supplied on a "made to order" basis at slightly higher cost than the other materials.

*Typical uses:* Parts for radio receivers and amplifiers, electronic condensers, audio oscillators, signal generators.

Recommended to molders and manufacturers desiring approval under MIL-P-14A

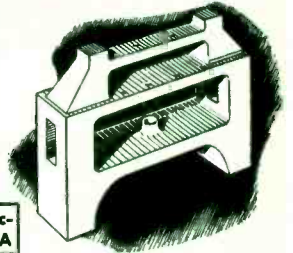

### BM-16981 NATURAL "LOW LOSS" MATERIAL

Has exceptionally good electrical properties which are retained under moist service conditions. Easier to mold than BM-262, and somewhat lower in cost.

*Typical uses:* Electronic capacitors, resistors, and parts for radio, radar, X-ray and similar equipment.

Recommended to molders and manufacturers desiring approval under MIL-P-14A

The black counterpart of this material is BM-17080.

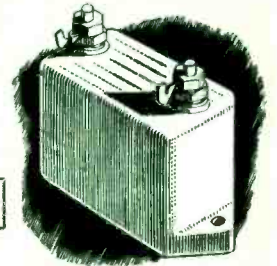

### BM-17748 NATURAL "LOW LOSS" MATERIAL

Has greater moldability than either BM-16981 or BM-262. Good electrical properties under moist service conditions. More stable dimensionally than most phenolic molding materials.

*Typical uses:* Coil forms, vacuum tube bases, condenser housings and resistors.

Recommended to molders and manufacturers desiring approval under MIL-P-14A

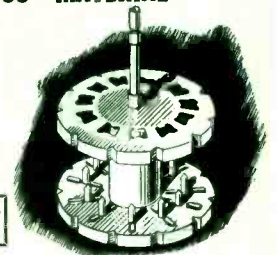

### BM-13017 NATURAL "LOW LOSS" MATERIAL

Has greatest moldability of all materials in the "low loss" group. Has excellent electrical insulating properties in general, although not intended for high frequency service. Highly resistant to moisture. Dimensionally stable.

*Typical uses:* For less exacting electrical service such as automotive ignition parts and various types of resistors.



# BAKELITE Phenolic PLASTICS

**BAKELITE DIVISION**  
Union Carbide and Carbon Corporation  
30 East 42nd Street, New York 17, N. Y.



HF and UHF power leakage  
positively and economically  
controlled by  
new gasket material

The unique combination of controlled resiliency, stability and conductivity found in Metex "Electronic Weather Stripping" makes it particularly effective as a shielding material for such electronic applications as radar equipment, high frequency heating, television broadcasting and high frequency communication.

It is available in strips or in die-formed gaskets of the shape, size and volume required by the particular application. Economical in cost, the use of this material permits further savings in assembly time and eliminates much costly machining of closure surfaces that would normally be required.



#### "Electronic Weather Stripping"

The base material is a knitted—not woven—wire mesh which is made from any metal that can be drawn into wire. Knitting produces a mesh consisting of a multiplicity of interlaced loops which increase the normal resiliency of the wire and, by their hinge-like action, permit freedom of motion without loss of stability.

These characteristics are retained even when multiple layers of this mesh are compressed to form gaskets or strips. The result is a compressible, resilient, cohesive, conducting material with a large internal surface area. Where hermetic sealing is also required, these gaskets are made in combination with neoprene or similar materials.

#### Applications

Among the varied applications where Metex "Electronic Weather Stripping" has already proved its effectiveness and economy are: Air craft pulse modulator shields, waveguide choke-flange gaskets, shielding metal housings, replacing beryllium-copper fingers and springs on TR or ATR tubes, and ignition shielding to prevent radio noise interference. The facilities of our engineering department are available at any time to assist you in determining the possible adaptability of "Electronic Weather Stripping" to your specific requirements. A letter, addressed to Mr. R. L. Hartwell, Executive Vice President, and outlining briefly your particular problem will receive immediate attention.

## Metal Textile Corporation

641 East First Ave.

Roselle, N. J.

March, 1951 — ELECTRONICS

## NAMEPLATE PROBLEMS?

Send for this Manual of . . .

## MEYERCORD DECAL NAMEPLATES

### HOW TO SOLVE NAMEPLATE PROBLEMS ON ANY SURFACE

Most useful nameplate manual ever offered! Shows hundreds of uses for durable, washable Decal nameplates—as trademarks, instructions, charts or diagrams—in all sizes, colors and designs. Application is fast, easy, economical. On metal, glass, wood, china, plastic, leather, rubber, crinkle-curved, flat or flexible surfaces, Meyercord Decals provide low cost permanent identification.



# FREE!

WRITE FOR YOUR FREE COPY  
BUSINESS LETTERHEADS,  
PLEASE, DEPT. 41-3

## The MEYERCORD Co.

World's Largest Decal Manufacturer

5323 W. LAKE ST.

CHICAGO 44, ILL.

## "Black boxes" to your specifications RESEARCH · DEVELOPMENT · PRODUCTION

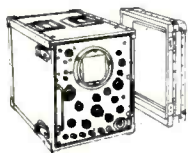

Special Test Equipment

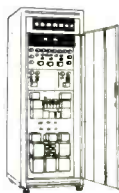

Regulated Power Supplies

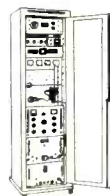

U.H.F. Equipment



Plotting Boards—such as the Vari-plotter Model 205 Series for accurately presenting X vs Y, curve following, point plotting, etc.

Electronic Associates, Inc., is a coordinated group of electronic engineering consultants fully equipped to perform electronic research, development and production. They include engineering, production, and administrative personnel capable of handling a wide range of problems including design studies, applied research, and the production of highly complex electronic devices.

Plant facilities comprise laboratories; model, welding and machine shops; paint, anodizing, and test departments; assembly and tool rooms; foundry and other contributing functions of production.

A few of the many products the Concern has manufactured are illustrated here.

See us in our Booth 98-99  
RADIO ENGINEERING SHOW  
New York, March 19-22

More detailed information will be furnished on request.

## ELECTRONIC ASSOCIATES, INC.

Long Branch, New Jersey

# Precision Built

*for the  
Finest Equipment*

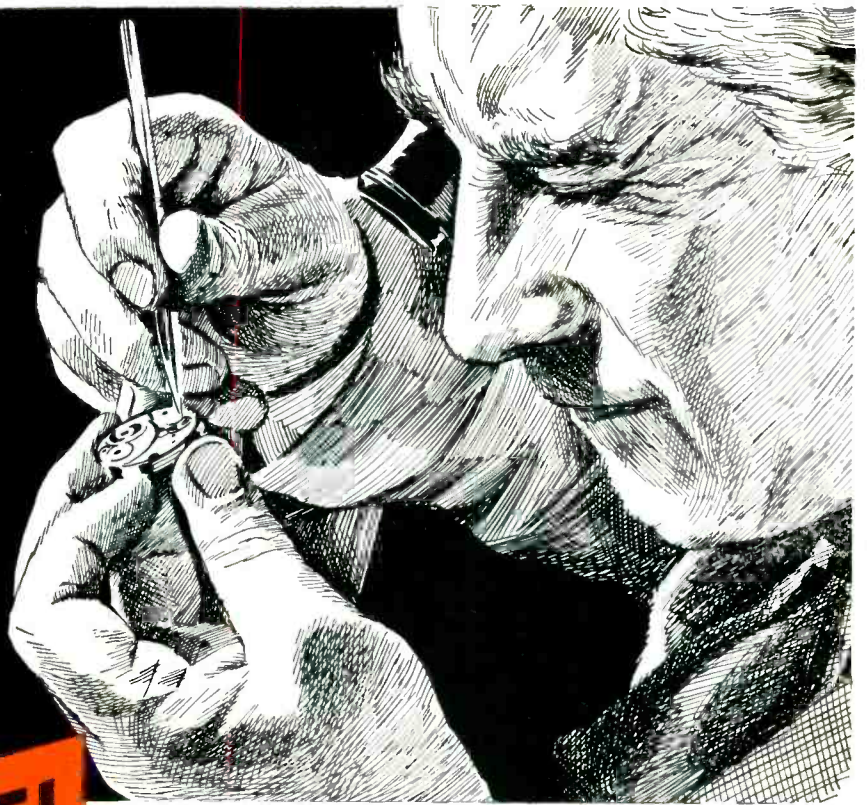

# FERRANTI

## Transformers

Our long experience in building all types of transformers, including hermetically sealed units, qualifies us as a dependable supply source for transformers used in military applications. We offer sound engineering and faultless craftsmanship . . . custom design with the economy and speed of modern mass production methods.

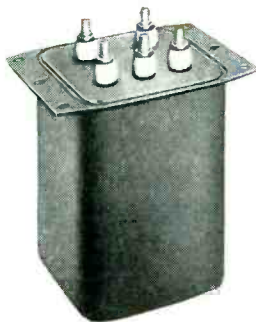

*Hermetically Sealed Types for MIL-T-27 applications . . . Special Cores . . . High Temperature Insulation . . . as well as all normal types for every purpose.*

**FERRANTI ELECTRIC, INC.**

30 Rockefeller Plaza, New York 20, New York

*There is No Finer Name in Transformers than*

# FERRANTI



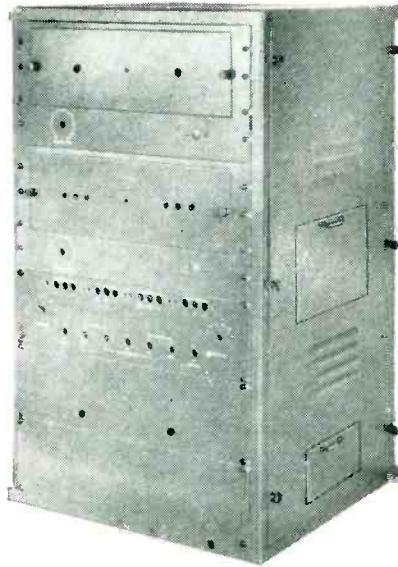

used for cross-band operations from 2 to 10 meters, 11 to 20, and 75 meters and so on.

While usable results may be obtained by bridging together the transmitter input, receiver output and telephone line termination, the audio gain of the radio circuit must be kept down to very low values or oscillations (singing) will result because of the continuous path existing around the radio circuit loop. To overcome these difficulties, telephone engineering practices prescribe a hybrid circuit, Fig. 2. In the ideal case, the balancing network  $C_2, R_5$  is an exact replica of the impedance presented at the terminals leading into the wire line. Under these conditions, any voltage impressed by the radio receiver's output will leave the points, across which the transmitter is bridged, at the same potential. Therefore, no energy is transferred to the radio transmitter's input circuit. Incoming signals from the telephone line, however, will produce a voltage across the input of the radio transmitter. Theoretically, this method permits circuit stability with high audio gains.

For perfect balancing, it would be necessary to provide a special network for the particular telephone line which connects to the radio equipment. It has been found, for all practical purposes, that a compromise balance, as  $C_2, R_5$ , may be utilized to represent the average impedance of the telephone line. Sufficient audio gain values can be obtained with this balancing network for telephone operations and, at the same time, it will maintain a sufficient margin of safety below the singing point. To save space,

We're Ready to Give You  
**PROMPT DELIVERY** on

**CABINETS**

**HOUSINGS**

**CHASSIS**

**SHELF ASSEMBLIES**

**CORRY-JAMESTOWN** is gearing its facilities once again to the production of sheet metal components and finished assemblies for the electronics industry. We're ready with the latest time-saving metal fabricating equipment . . . skilled craftsmen . . . a staff of highly specialized engineers . . . and the production know-how of 30 years experience fabricating steel, stainless steel and aluminum. Best of all, a high regard for quality has always been second nature with us. We're ready, *right now*, to sit down with you over your blueprints . . . or to send you detailed information on our equipment, our capacity, etc. Your inquiries are invited.

*We have the skilled manpower and facilities you need*

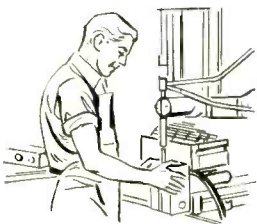

FAST, AUTOMATIC WELDING EQUIPMENT



LARGE VARIETY OF PRESSES AND BRAKES

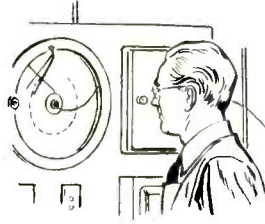

MODERN AUTOMATIC FINISHING EQUIPMENT

**CALL, WRITE OR WIRE US TODAY!**

**CORRY-JAMESTOWN MFG. CORP.**

CORRY, PENNSYLVANIA

*Makers of famous Steel Age office furniture*

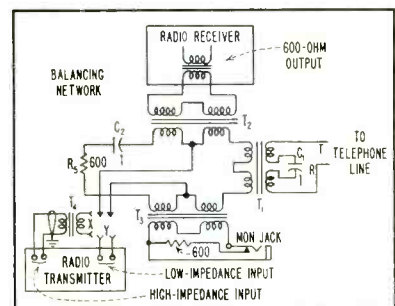
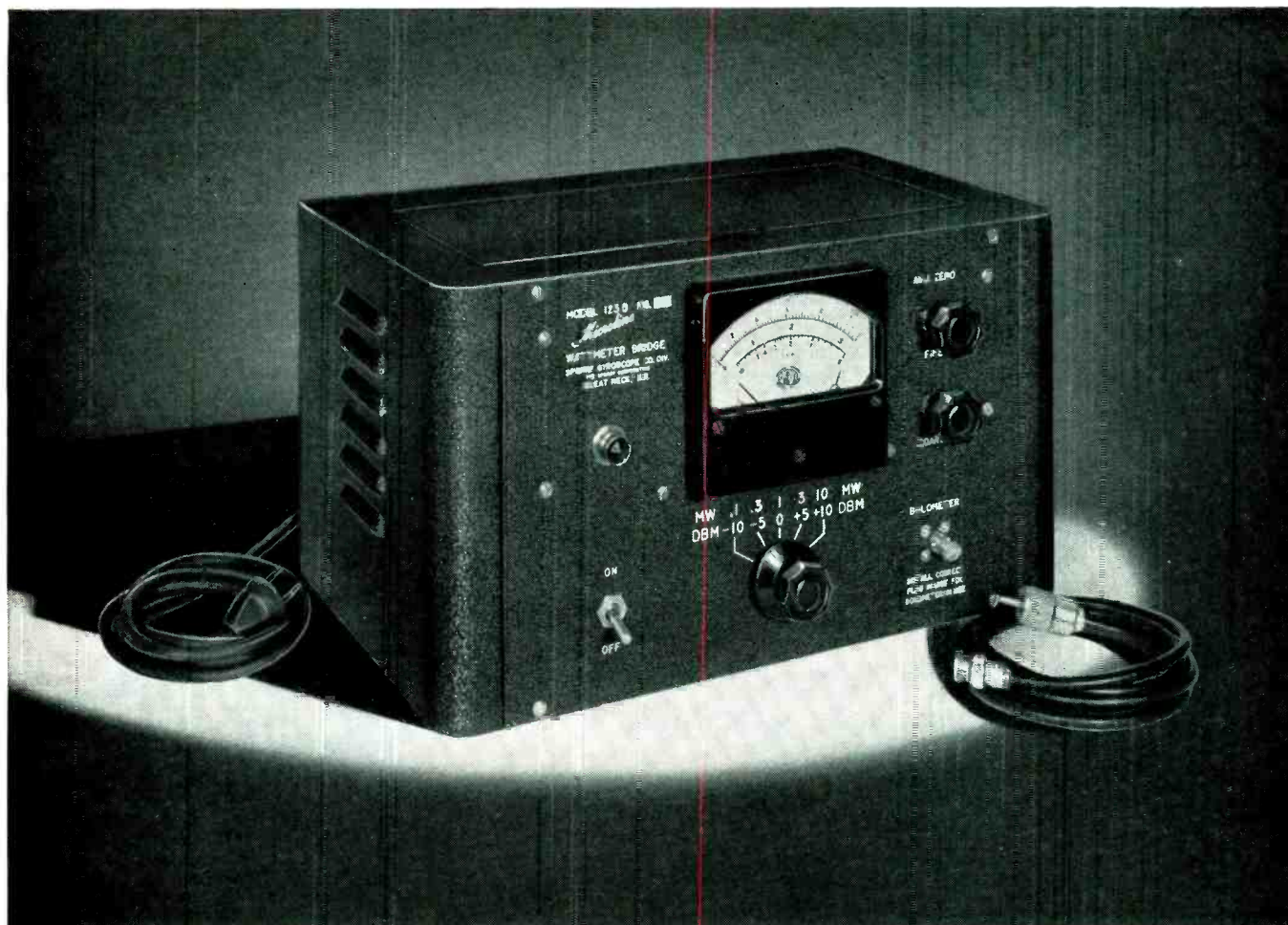

FIG. 2—Telephone line connection for full duplex operations or for initial simplex where duplex switching is planned for future use



## ACCURACY AND FLEXIBILITY WITH NEW WATTMETER BRIDGE

Another addition to Sperry's complete line of microwave test and measuring equipment, *Microline*, is a new, highly-accurate Wattmeter Bridge. Model 123B is extremely versatile and will not be made obsolete by future requirements in bolometer operating resistance.

► With accuracy to which power dissipated in the bolometer element can be measured to  $\pm 3\%$  of the full scale reading, this meter is capable of operation with either thermistor or barretter. This is possible by the selection of the proper plug-in unit (listed in table at right).

► Model 123B is calibrated in both milliwatts and DBM. Five power ranges are available 0-0.1, 0.3, 1.0, 3.0 and 10.0 milliwatts. Pulse power, as well as c-w power, can be measured with this bridge and appropriate bolometers.

► Write our Special Electronics Department for further details.

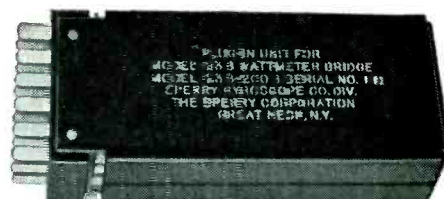

Model 123B Wattmeter Bridge is supplied with any one of the following plug-in units:

- 200B for 200 ohm barretter operation
- 125B for 125 ohm barretter operation
- 200T for 200 ohm thermistor operation
- 135T for 135 ohm thermistor operation
- 100T for 100 ohm thermistor operation

Visit our booths 57-58-59 at the Radio Engineering Show, March 19-22.

# SPERRY *GYROSCOPE COMPANY*

DIVISION OF THE SPERRY CORPORATION, GREAT NECK, NEW YORK · CLEVELAND · NEW ORLEANS · NEW YORK · LOS ANGELES · SAN FRANCISCO · SEATTLE



Announcing a **NEW**

# CIRCUIT ELEMENT the SIGNATRON

A high Q electro-mechanical resonator of small size and great stability for use as

- A **TRANSDUCER** of pressure, temperature, acceleration, displacement, strain, etc. for FM telemetering systems.
- An **OSCILLATOR** of near crystal stability with a wide tuning range.
- A **DISCRIMINATOR** to convert FM signals to amplitude variations.
- A **FILTER** with a Q range from 300 to 2500.

WILL BE DEMONSTRATED AT OUR EXHIBIT BOOTH 271,  
IRE SHOW, NEW YORK, MARCH 19-22

for information write

**RAHM INSTRUMENTS Inc., 12 W. Broadway, N. Y. 7, N. Y.**

manufacturers of

Direct Recording Oscillographs and Amplifiers

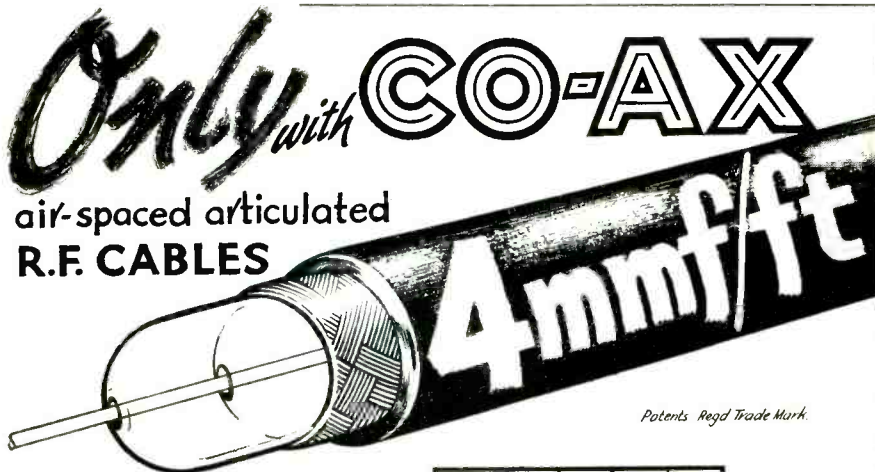

Patents Regd Trade Mark.

## THE LOWEST EVER CAPACITANCE OR ATTENUATION

We are specially organized to handle direct enquiries from overseas and can give

**IMMEDIATE DELIVERIES FOR U.S.A.**

Billed in Dollars Settlement by your check.  
Transaction as simple as any local buy.

**TRANSRADIO LTD**

CONTRACTORS TO H.M. GOVERNMENT  
138A CROMWELL ROAD - LONDON SW7 ENGLAND  
CABLES: TRANSRAD. LONDON.

LOW ATTEN TYPES	IMPED OHMS	ATTEN db/100ft of 100 Mc/s.	LOADING A/w	O.D."
A 1	74	1.7	0.11	0.36
A 2	74	1.3	0.24	0.44
A 34	73	0.6	1.5	0.88
LOW CAPAC TYPES	CAPAC mmf/ft.	IMPED OHMS	ATTEN db/100ft 100Mc/s.	O.D."
C 1	7.3	150	2.5	0.36
PC 1	10.2	132	3.1	0.36
C 11	6.3	173	3.2	0.36
C 2	6.3	171	2.15	0.44
C 22	5.5	184	2.8	0.44
C 3	5.4	197	1.9	0.64
C 33	4.8	220	2.4	0.64
C 44	4.1	252	2.1	1.03

★ Very Low Capacitance cable.

**HIGH POWER  
FLEXIBLE**

**PHOTOCELL  
CABLE**

**V. L. C. ★**

Where the  
Requirements  
are Extreme...

Use  
**SILVER  
GRAPHALLOY**

For extraordinary  
electrical performance



**THE SUPREME BRUSH  
AND CONTACT MATERIAL**

### IN BRUSHES

- for high current density
- minimum wear
- low contact drop
- low electrical noise
- self-lubrication

### IN CONTACTS

- for low resistance
- non-welding character

Graphalloy is a special  
silver-impregnated graphite

Accumulated design experience counts —  
call on us!

**GRAPHITE METALLIZING  
CORPORATION**

1055 NEPPERHAN AVENUE, YONKERS 3, NEW YORK

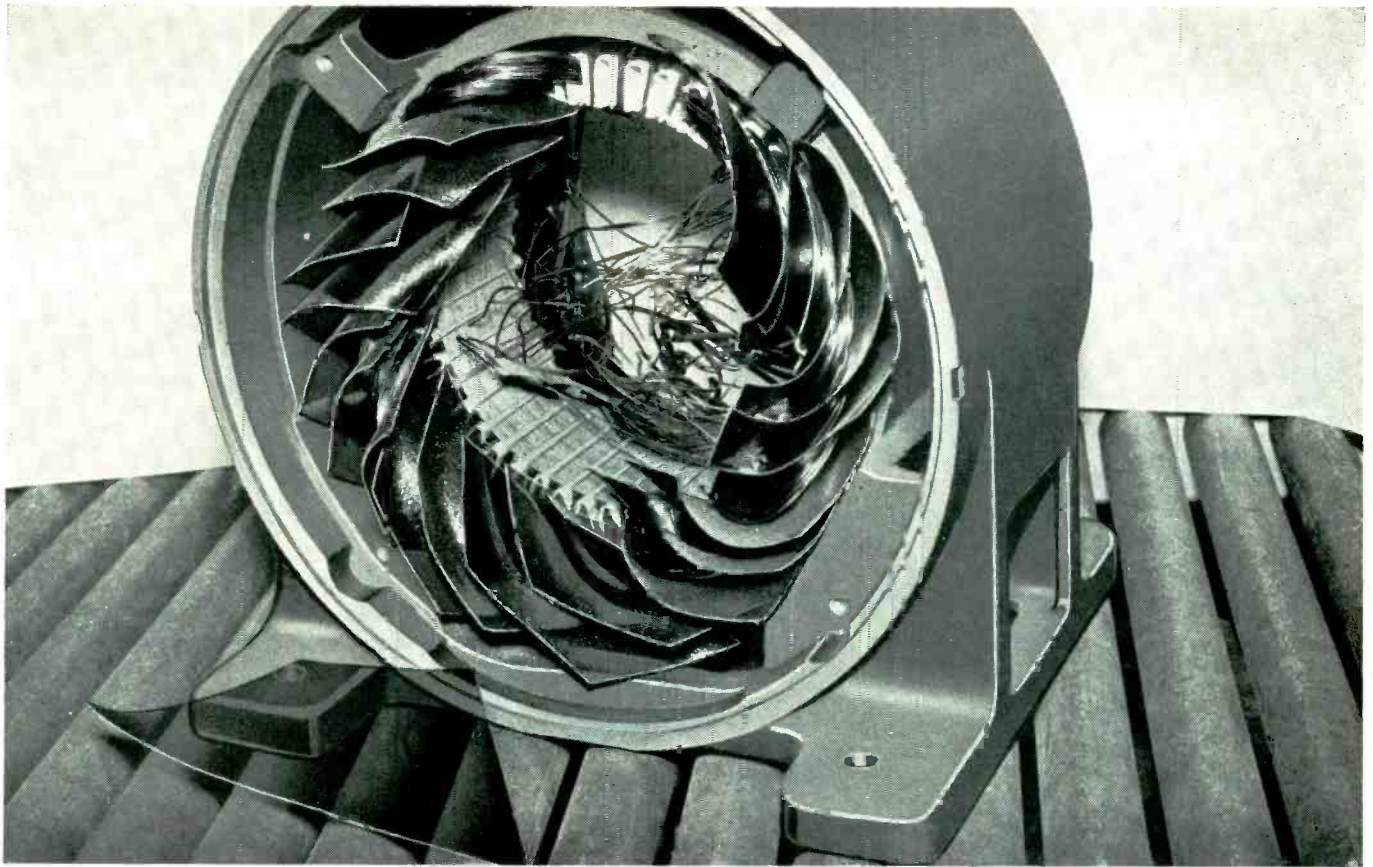

## When insulation must stand 500° Heat ...look to **IRVINGTON'S** Class "H" Line

Whether you are winding for service at high ambient temperatures — for increased *continuous* power ratings — for greater *short-time* overload capacity ...

Or *designing* for space-and-weight savings ...

You will find the Class "H" insulation you want in the complete Irvington line.

Depending on service requirements, *your* high-temperature insulation job may call for Silicone Varnished Fiberglas\*, in yard goods, tape or tubing forms; Silicone Glass Mica; Silicone Saturated or Silicone Coated Asbestos; Silicone Rubber Coated Fiberglas; Silastic\*\*Tape, Teflon Coated Fiberglas.

We make them *all* — we're ready to help you use *each* to best advantage. Write for a free copy of our book — Irvington Class "H" Insulations — it contains samples. Perhaps you'd prefer to talk with one of our engineers. The coupon below is for your convenience. Send it today. No obligation.

\*Owens-Corning Fiberglas Corp. \*\*Dow Corning

Look to  
**IRVINGTON**  
 for insulation leadership  
 INSULATING VARNISHES  
 VARNISHED CAMBRIC  
 VARNISHED PAPER  
 VARNISHED FIBERGLAS  
 INSULATING TUBING  
 CLASS "H" INSULATION



Send this convenient coupon now

# Irvington

VARNISH & INSULATOR COMPANY

6 Argyle Terrace, Irvington 11, New Jersey

Irvington Varnish & Insulator Co.  
 6E Argyle Terrace, Irvington 11, N. J.

EL-3/51

Please send me a free copy of "Irvington Class 'H' Insulations".

I'd like to see one of your engineers. Please have him phone or write for an appointment.

Name..... Title.....

Company.....

Address..... Phone.....

City..... State.....



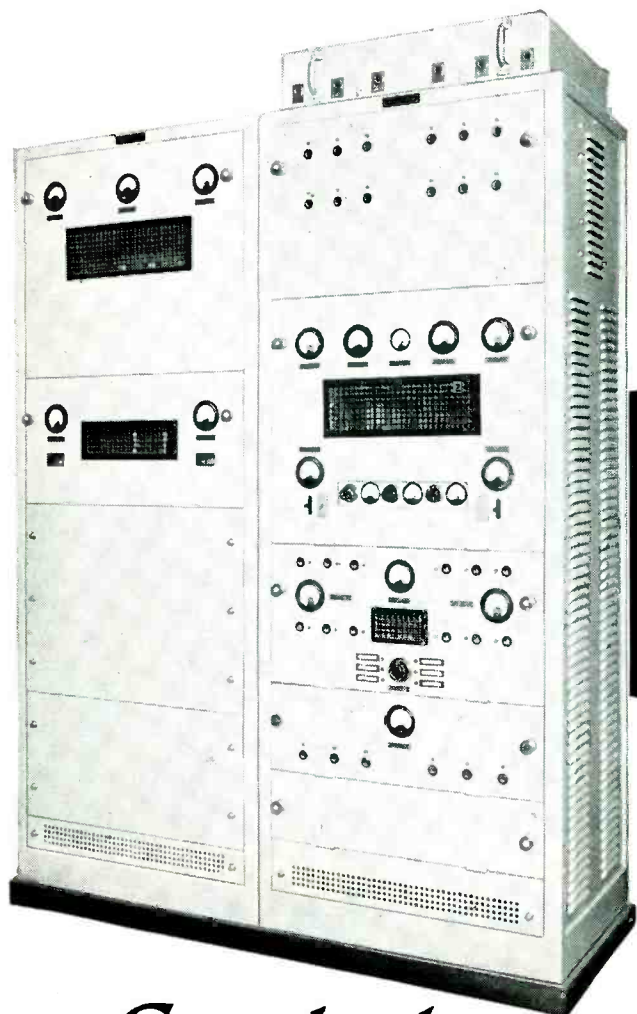

Available for  
**immediate  
delivery**

## Standard High Frequency Transmitter

### Type E. S. 4 - A

A short wave general purpose transmitter specially designed to meet the requirements of modern low and medium power commercial installations.

<b>Service</b>	C.W., $\frac{1}{4}$ power C.W., M.C.W., Telephony and F.S.K.
<b>Frequency Range</b>	1.76-20 mc/s (15-170 metres) with 6 pre-set frequencies.
<b>Output Power</b> (Into Antenna Circuit)	800-1,300 watts Carrier on C.W. and F.S.K. 250 watts Carrier on M.C.W. and Telephony.

<b>Principal Features</b>	Provides a number of independent operating channels. Any one of the operating channels can be selected instantly. Any channel will operate into common or separate, balanced or unbalanced aeriels or lines. Automatic connection of appropriate aerial for channel selected. Provision of variable frequency control combined with "spot" frequency operation. Speech amplifier incorporates V.O.G.A.D. High-speed keying available if required. Complete remote control including channel, service and aerial selection. Deep, high quality modulation on telephony. Compactness-accessibility-ease of maintenance. With suitable Drive Unit, the transmitter provides frequency-shift as well as "on/off" keying services. Tropical finish.
---------------------------	---

## Standard Telephones and Cables Limited

An I.T. & T. Associate  
RADIO DIVISION . New Southgate, London, N.11, England.

the three transformers or repeating coils,  $T_1$ ,  $T_2$  and  $T_3$  of Fig. 2, may be combined into one hybrid coil as shown in Fig. 3. The overall dimensions of such a hybrid coil are only about  $3\frac{1}{2}$  by 2 by 2 inches. The use of a single transformer of the multiwinding hybrid type makes it possible to assemble the entire four-wire—two-wire termination set on a 4 by 8-inch size panel.

### Use of Monitoring Jack

The monitoring jack connected across the secondary winding of transformer  $T_3$ , Fig. 2, may be utilized for the following purposes:

(1) A pair of head-phones may be plugged into the jack to monitor the communication channel.

(2) A db meter, vtvm, or similar device may be inserted to measure

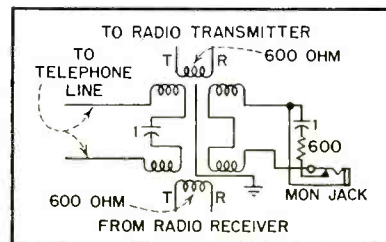

FIG. 3—Duplex switching connection with the repeating coils combined into one hybrid coil

the relative audio levels and to check the balance of the hybrid termination. These instruments should be terminated in 600 ohms (if not so designed) in order to obtain accurate measurements.

(3) Another telephone circuit can be connected to the monitoring jack for a conference circuit.

### Audio Level Adjustments

Most radiotelephone transmitters used at amateur radio stations are designed for use with high-impedance microphones of the crystal, dynamic or similar types. These microphones have a low-level output, usually in the order of  $-30$  db to  $-55$  db. The speech input from the ordinary telephone line ranges from about 0 db to  $-20$  db. It is necessary, therefore, to reduce materially the gain of the speech amplifier of the radio transmitter. In this connection, the amplifier gain control should be adjusted for full modulation of the radio transmitter

# Floating Action here...

## Keeps Telechron motors right on time

This rotating magnetic field virtually makes the rotors float!

These lightweight floating rotors start instantly... stay in "sync"!

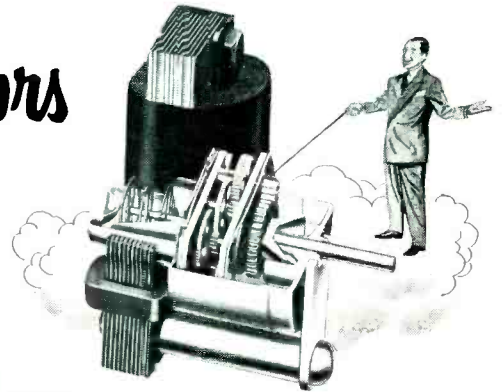

The shaft floats on oil-coated bearing surfaces. No metal to metal contact!

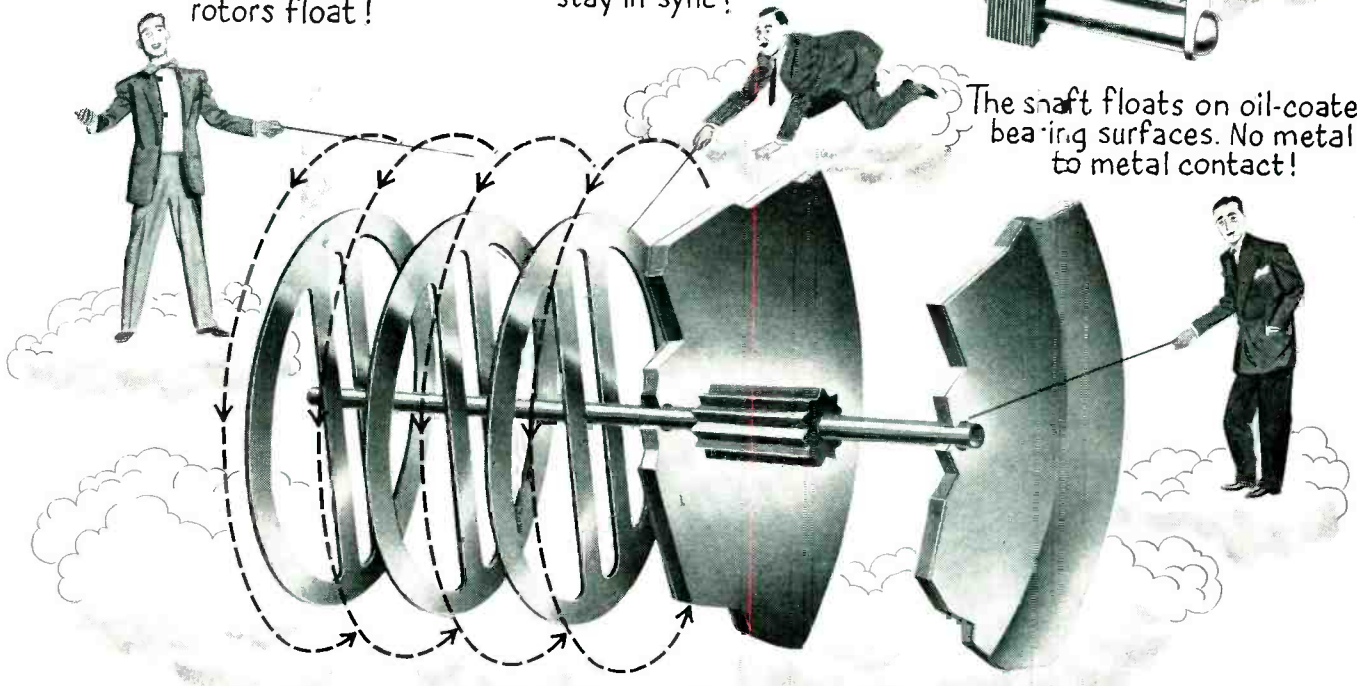

## Maybe Floating Action can improve your timing, too!

Split-second timing and precise control of lightweight moving parts are jobs that Telechron synchro-sealed motors do best. The unique floating action of the rotor is just one of many features that make them instantly self-starting and keep them constantly synchronous for years.

Telechron timing motors have an outstanding record of accurate performance. The more than 50,000,000 Telechron motors used in instruments, timers, electric clocks, cost recorders, cycle con-

trollers, etc. in the past 30 years are your assurance of perfect satisfaction. And remember, the world-wide recognition of Telechron Inc. in the timing field also adds a valuable sales feature to your product. Why not talk your timing problems over with a Telechron application engineer? In the meanwhile, write for Bulletin IS-110 for torque ratings and other up-to-the-minute data on Telechron synchronous motors and instrument movements. TELECHRON INC. A GENERAL ELECTRIC AFFILIATE.

ALL TELECHRON TIMING MOTORS are Instantly... Constantly Synchronous

READ ALL ABOUT FLOATING ACTION IN THIS BULLETIN



TELECHRON INC.  
43 Union Street, Ashland, Massachusetts

Please send me Bulletin IS-110 which gives torque ratings, specifications and other application data on Telechron synchronous motors and instrument movements.

Name ..... Title .....

Company .....

Address .....

City ..... Zone ..... State .....



the  
new  
**PRECISION  
COIL  
BOBBINS**

NO INSULATION STRIPS NEEDED  
STRONGER MAGNETIC FIELDS  
CLOSER WINDINGS

with Anchored Flanges . . .  
can't come loose!

Flanges are securely locked in place on a plastic-coated core to assure coils wound to closer tolerances—fewer rejects. Flange cannot slide to allow crowding of turns—wire cannot slip off coil form. Spiral winding—heavy heat-treated compression—overall impregnation. Made in any shape or size to your specs. of finest dielectric Kraft, fish paper, cellulose acetate or combination.

Write for FREE sample TODAY



**PRECISION PAPER TUBE CO.**

2041 W. Charleston St.

Chicago 47, Ill.

Plant #2, 79 Chapel St., Hartford, Conn. Also Mfrs. of dielectric paper tubes.

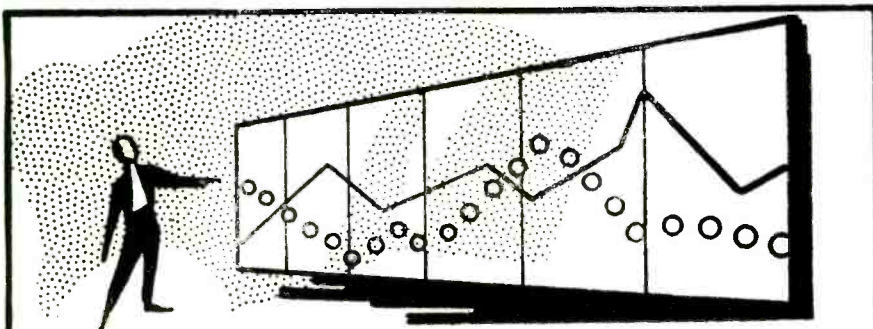

**TIME AND NUMBERS**

Do you need a permanent record of time and numbers, that apply to your laboratory or production work? Streeter-Amet has the instrument which will accurately and speedily record either numbers or time or both at the same time on paper tape for easy readability.

The counter operates by any means capable of supplying a switch closure or an electrical impulse. Counts may be indexed by time or number printed alongside the count.

For high speed counting of a predetermined number of articles, Streeter-Amet Predetermined Counters automatically count then shut off or control associated machinery when the predetermined number is reached. An outstanding timesaver when packing a given number of articles in a carton, measuring lengths of wire or sheets in a bundle.

Tell us your specific counting problem. We know we can help you economically.

Write for Illustrated circular  
SC 26



FOUNDED  
1888

SCALES · WEIGHT RECORDERS · HI-SPEED COUNTERS  
**STREETER - AMET COMPANY**  
4101 N. RAVENSWOOD AVE., CHICAGO 13, ILL.



WITH **SIGNAL  
GENERATORS**

by  
**AIRCRAFT RADIO Corporation**



**TYPE H-14 108-118 MEGACYCLES**

Standard signal source for complete testing of VHF airborne omnirange and localizer receivers in aircraft or on the bench is ARC's Type H-14 Signal Generator. It checks up to 24 omni courses, omni course sensitivity, to-from and flag-alarm operation, left-center-right on 90/150 cycle and phase-localizers, and all necessary quantitative bench tests. Permits quick, accurate, check-out of aircraft just before take-off. For ramp checks RF output 1 volt into 52 ohm line; for bench checks, 0-10,000 microvolts. AF output available for bench maintenance and trouble shooting.

Price \$885.00 net, f.o.b. Boonton, N.J.

**Type H-12 VHF Signal Generator**  
900 - 2100 mc—source of cw or pulse amplitude-modulated RF. Power level 0 to -120 dbm. Internal pulse circuits with controls for width, delay, and rate, and provision for external pulsing. Frequency calibration better than 1%. Built to Navy specs for research, production testing. Equal to

Military TS-419/U.



Price: \$1,950.00 net  
f.o.b. Boonton, N.J.

**AIRCRAFT RADIO CORPORATION**  
Boonton New Jersey

Dependable Electronic Equipment Since 1928



**we'll pick our  
engineering brains  
especially for YOU**

**...if electronic components, such as high voltage  
condensers, are your problem**

*Built in quantity  
to your most exacting specifications  
for stability in service*

**JEFFERS**  
*Electronics* **INC.**

A SPEER CARBON COMPANY SUBSIDIARY

DU BOIS, PENNSYLVANIA

Complete your Circuits with Resistors, Coil Forms and Iron Cores by Speer Resistor Corp., St. Marys, Pa. another SPEER CARBON CO. subsidiary



## LOW-COST PROTECTION for Airborne Electronic Equipment

### *New* LORD \*TEMPROOF Mountings

- Exceed AN-E-19 Drop Test Requirements
- Designed for JAN-C-172A Equipment
- Maintain Efficiency from  $-80^{\circ}\text{F}$  to  $+250^{\circ}\text{F}$

\*Temperature-proof

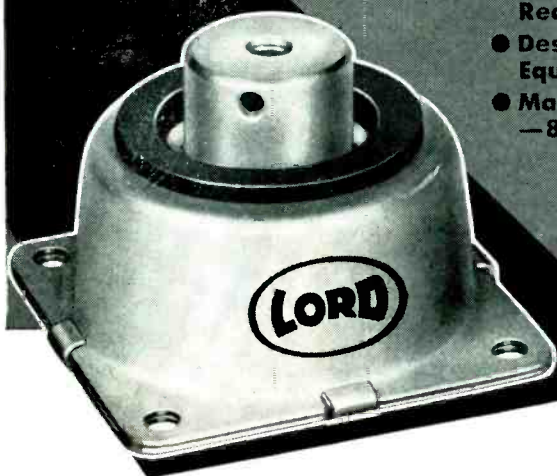

Here is reliable vibration protection for base-mounted airborne electronic equipment . . . and for other apparatus which must function properly above and below usual temperatures. And TEMPROOF Mountings are priced to meet the needs of manufacturers in competitive markets.

TEMPROOF Mountings provide superior protection by maintaining their high vibration-isolating efficiency from  $-80^{\circ}\text{F}$  to  $+250^{\circ}\text{F}$ . Selective-action friction dampers prevent excessive movement at resonant frequencies. Equipment does not sag or droop . . . mounting drift is negligible. The unusually wide load range of TEMPROOF Mountings makes it possible to standardize on one mounting for several types of equipment, and to effect additional economies in purchasing, storage and assembly.

*For complete information on TEMPROOF Mountings, or for specific recommendations concerning their use, write to Product and Sales Engineering Department. A quantity of Vibration Isolation and Natural Frequency Charts in full color is available. Copy of each will be sent free upon request.*

**LORD MANUFACTURING COMPANY • ERIE, PA.**  
Canadian Representative: Railway & Power Engineering Corp., Ltd.



**Vibration-Control Mountings  
... Bonded-Rubber Parts**

on the incoming speech from the telephone line. This usually requires the operator to ride the gain of the transmitter on a connection to the telephone network.

During the reception period, the volume control of the radio receiver should be adjusted to give sufficient audio level to the telephone line, corresponding to average speech conditions. Telephone companies usually require that audio inputs to their lines from amplifying devices should not be greater than about +8 db, based on 12 mw reference and care should be taken not to exceed this value. Crosstalk may be present in telephone cables at high audio levels and this condition must be avoided at all times. It is suggested that a db meter or v-u meter, terminated in 600 ohms, be bridged across the tip and ring of the telephone line to check the audio level from the radio receiver. The volume control of the receiver should be adjusted for optimum operation, exercising care not to exceed the 8-dbm level on average peaks. A vvm or db meter also may be connected to the monitoring jack to monitor levels after the initial adjustments are made and reference values established.

#### *Repeating Coils*

The repeating coils or transformers described are standard types made by telephone manufacturing companies. It is possible to utilize Army surplus types in place of transformers  $T_1$ ,  $T_2$  and  $T_3$ , Figs. 1 and 2. The Signal Corps type coil C-161 or repeating coil C-112 may be substituted for  $T_2$  and  $T_3$ .

If a type C-161 coil is used in place of repeating coil  $T_1$ , it is desirable to install a dpst switch to disconnect this coil from the telephone line when not in use because this type of repeating coil has no split windings for the insertion of a 1- $\mu\text{f}$  d-c blocking capacitor across the telephone line. It is not advisable to insert a series blocking capacitor because of the resultant mismatch and distortion introduced in the telephone circuit.

This article was abstracted from a paper entitled "Extending Radio Circuits To Wire Line Facilities for Emergency Communications",



Permafil

D-C CAPACITORS

for ambient temperatures

from **-55°C**

to **+125°C**

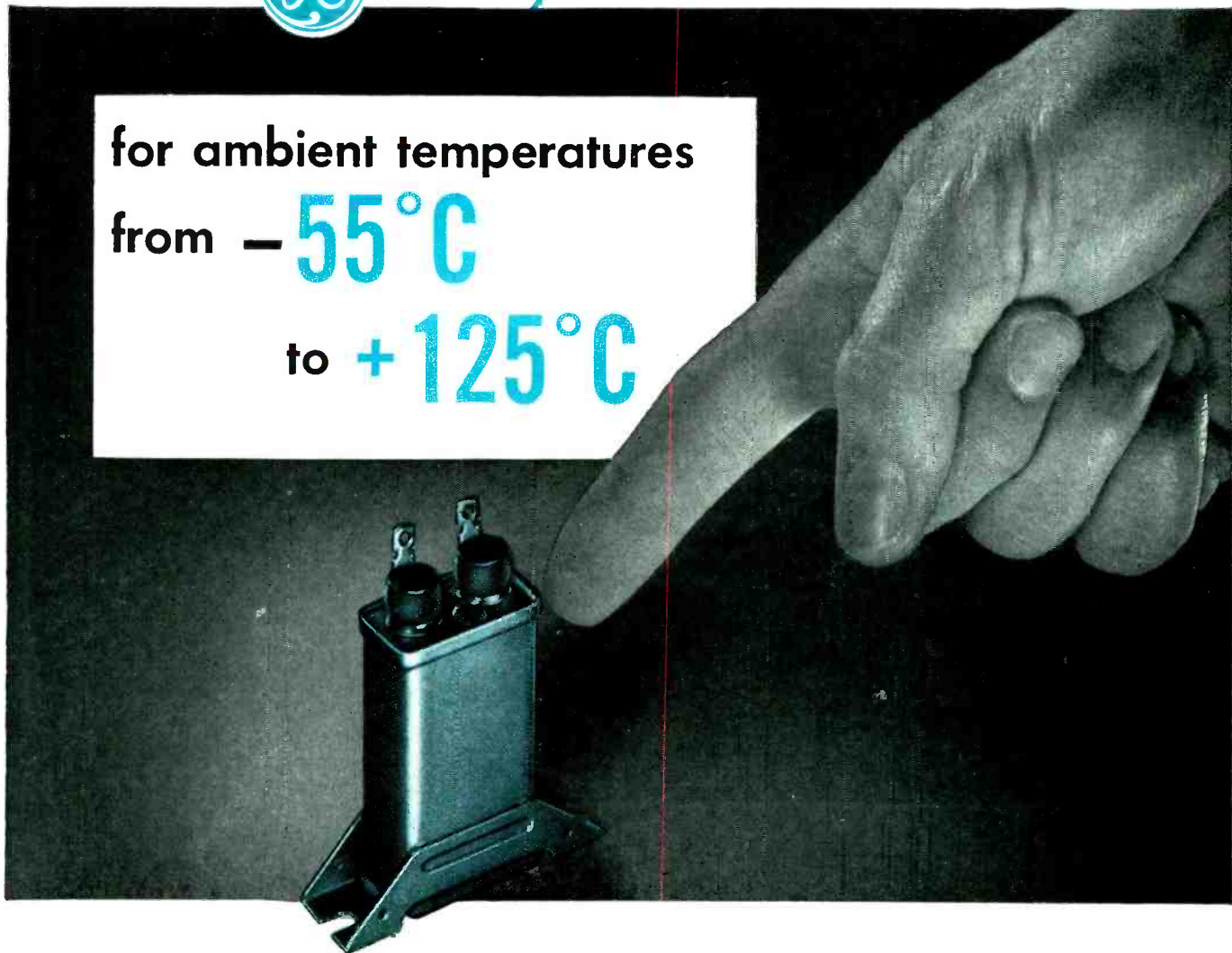

General Electric Permafil capacitors are designed for use at extremes in temperature—in high ambients—or in high altitudes where extreme cold is encountered. They are suitable for all blocking, by-pass and filtering applications.

These capacitors, while using paper dielectric, are treated with a plastic compound that retains its electrical stability at both high and low operating temperatures. Units are available in case styles CP-53, 61, 63, 65 and 70, as covered by specifications JAN-C-25—in ratings of .05 to 2.0 muf, 400 volts DC. Containers are metallic and are sealed with G-E long-life all-silicone bushings.

For full information on Permafil capacitors see your local G-E representative. Or write *Apparatus Department, General Electric Company, Schenectady 5, New York.*

**Where space or weight are especially important**

Permafil capacitors will average about 1/10 the size and weight of liquid-filled capacitors when designed to operate at 125° C.

Where short-life characteristics are permissible additional savings in size and weight are possible. If you have a short-life capacitor application in mind, G-E engineers would like to discuss it with you.

GENERAL



ELECTRIC

407-302



Another  
**PRECISION  
PRODUCT**

**Burlington**

## RUNNING TIME METER



- Designed for use on AC lines where successful servicing of electronic or electrical equipment depends upon the regular servicing of such equipment based on actual operating (or idle) time. Unit has a range of 9999.9 hours and resets automatically at 10,000 hours. Can be supplied for either 120 or 240 volts. 60 cycle operation and has operating temperature of  $-55$  to  $+55^{\circ}$  C.

- The Running Time Meter is housed in Burlington's attractive, black bakelite 3" square or 3 1/2" round case.

Write Dept. F 31 for further details.

- 9999.9 hour range
- 10,000 hour automatic reset
- $-55$  to  $+55^{\circ}$  C operating temperature

**BURLINGTON INSTRUMENT COMPANY**  
BURLINGTON, IOWA

Need **VOLUME**  
on Small Parts  
Like  
These?



## Investigate MULTI-SWAGE

### Economy Way to Get Volume!

If it's VOLUME you need on small tubular metal parts similar to these, be sure to look into Bead Chain's MULTI-SWAGE Process. Send the part (up to 1/4" dia. and to 1 1/2" length) and your specs for a quotation. Chances are you'll find a new way to effect important savings.

### Much Cheaper Than Solid Pins

Many prominent users of solid pins for electronic and mechanical purposes have cut costs by switching to Multi-Swaged tubular pins . . . without sacrificing strength or accuracy. Often this is possible to accomplish.

### Typical Applications —

As terminals, contacts, bearing pins, stop pins, male-female connections, etc., in a wide variety of electronic and mechanical products:—Toys . . . Business Machines . . . Ventilator louvers . . . Radio and Television apparatus . . . Terminal-boards . . . Electric Shavers . . . Phono Pick-ups, etc. For DATA BULLETIN, write to



The **BEAD CHAIN** Mfg. Co.  
88 Mountain Grove St., Bridgeport 5, Conn.

Manufacturers of BEAD CHAIN—the kinkless chain of a thousand uses, for fishing tackle, novelty, plumbing, electrical, jewelry and industrial products.

**HEAT RESISTANT WIRES FOR EVERY APPLICATION . . .**

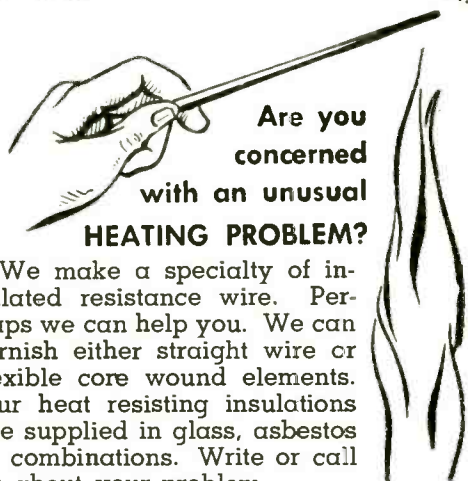

Are you  
concerned  
with an unusual  
HEATING PROBLEM?

We make a specialty of insulated resistance wire. Perhaps we can help you. We can furnish either straight wire or flexible core wound elements. Our heat resisting insulations are supplied in glass, asbestos or combinations. Write or call us about your problem.

Send your electronic control, communications or appliance wiring specifications for a recommended solution by our engineers.

FOR A TRIAL ORDER OR A CARLOAD consult

HEATING UNITS  
HEATING ELEMENT  
RESISTANCE  
LINE CORD  
THERMOCOUPLE WIRE  
ASBESTOS LEAD  
& FIXTURE WIRE  
INSULATED  
RESISTANCE WIRE  
FIBERGLAS  
INSULATED WIRE  
WIRE TO ANY  
SPECIFICATIONS



**THE LEWIS ENGINEERING CO.**

Wire Division  
NAUGATUCK CONNECTICUT



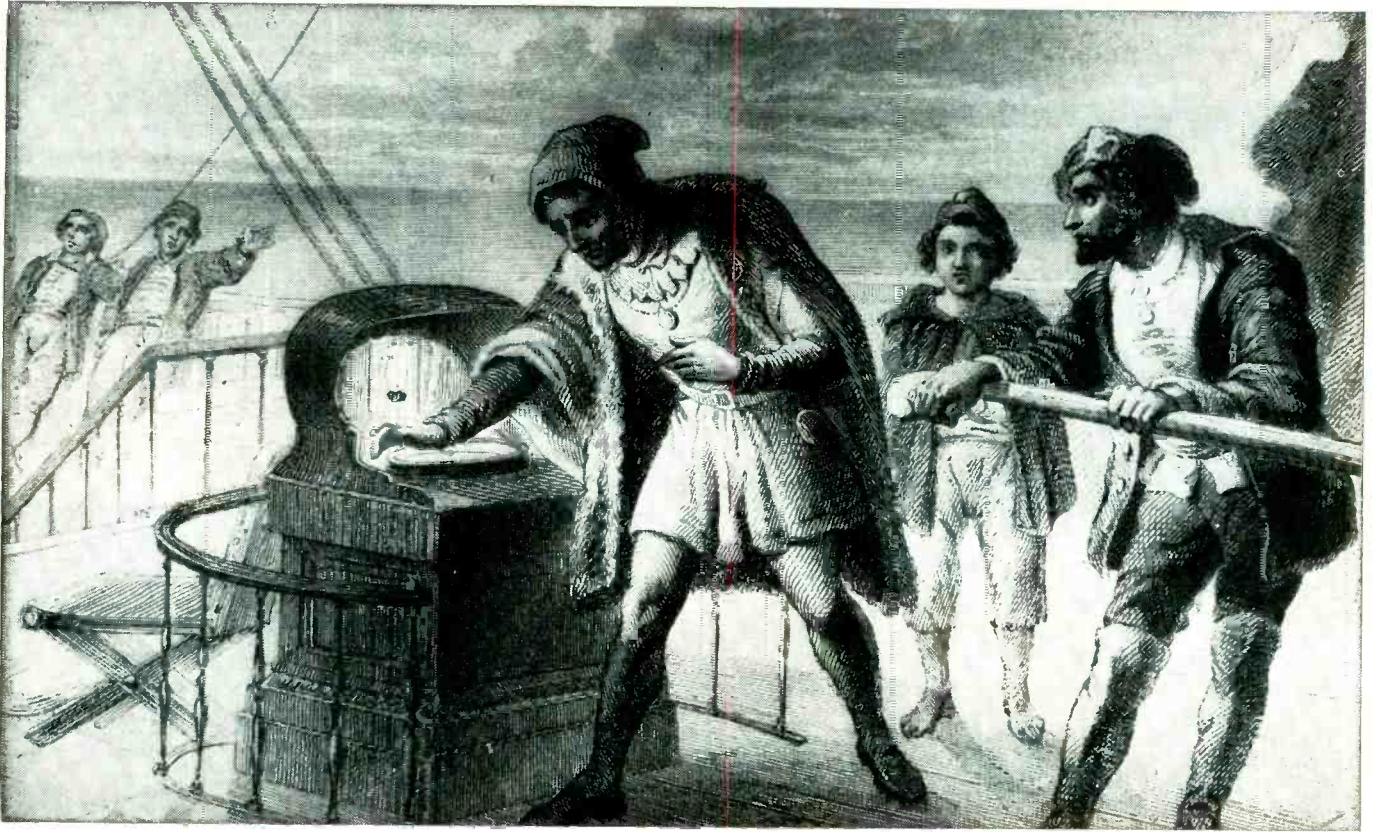

BETTMANN ARCHIVE

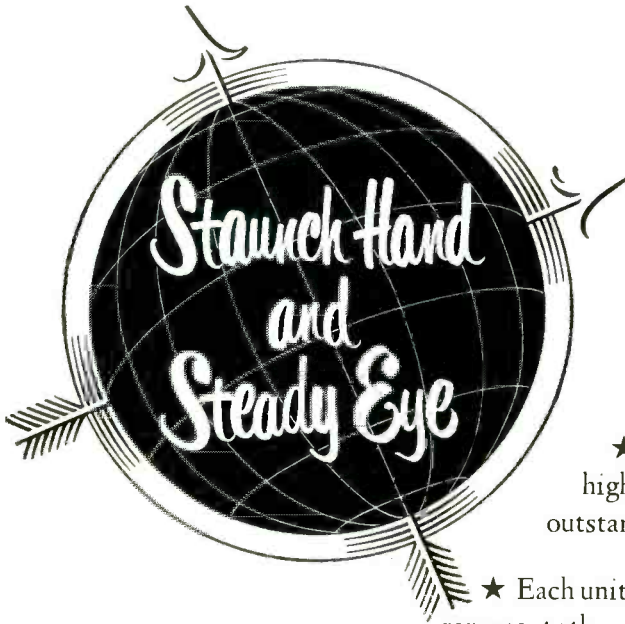

... the prime requisites and the mark of the master pilot throughout the ages.

But no hand, however staunch, no eye, however steady, could master the modern high-speed aircraft without aid from its complex instrumentation and control systems. These are the systems that strengthen the pilot's hand a hundred-fold . . . that present to his watchful eye, instantly and accurately, his progress in flight.

★ And the heart of these systems is frequently a small, high-precision electric motor produced by Kollsman engineers—outstanding specialists in the field.

★ Each unit in Kollsman's line of miniature special purpose motors represents the solution to a particular control problem. Each one has been engineered to provide specific performance characteristics, with the same high degree of precision for which Kollsman instruments and optics are known.

★ Today, the skill and experience of Kollsman engineers, in combination with all resources of the Kollsman Instrument Corporation, work unceasingly toward the solution of vital instrumentation and control problems.  
Kollsman Instrument Corporation, 80-08 45th Avenue, Elmhurst, N. Y.

**KOLLSMAN INSTRUMENT CORPORATION**

ELMHURST, NEW YORK ● GLENDALE, CALIFORNIA



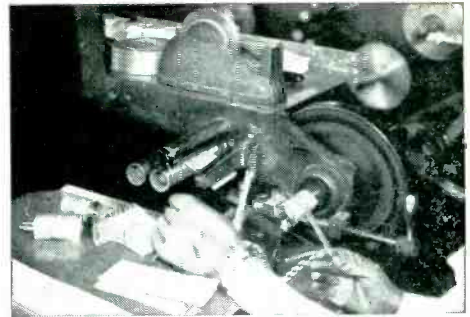

**MANUFACTURING** electrolytic condensers at The Magnavox Co., Fort Wayne, Ind. New high purity "SCOTCH" Electrical Tape No. 42 cuts corrosion and breakdowns.

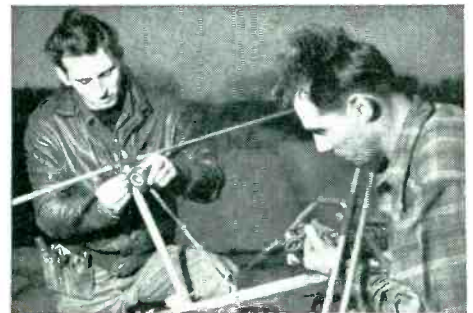

**INSTALLING** antenna lead in with "SCOTCH" Electrical Tape No. 33. Plastic-backed tape seals out moisture—prevents snow and ghosts.

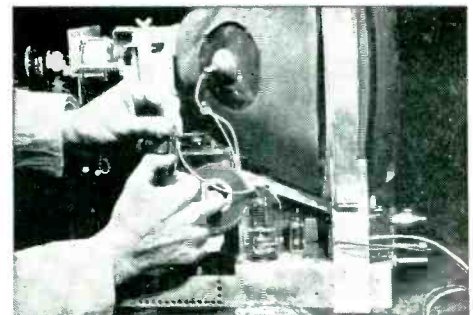

**MAINTAINING** TV with "SCOTCH" Electrical Tape No. 33 cuts repair time as much as 50 per cent. Leads are easily spliced. Difficult soldering is eliminated.

# GET THIS FREE BOOK: "Tapes for Television"

Shows you how TV manufacturers cut costs  
with "SCOTCH" Electrical Tapes

New booklet gives many time-saving uses of these modern, pressure-sensitive "SCOTCH" Electrical Tapes. Tells how high dielectric, mechanical strength and thin caliper equip these tapes for use in the manufacture, installation and maintenance of television sets.

There are over 30 different tape formulations, many types of backings including plastic, acetate, cloth, treated paper. Get the details on how stick-at-a-touch "SCOTCH" Electrical Tapes are filling every TV taping need. Mail the coupon below to Dept. ES351.

**MINNESOTA MINING & MFG. CO., DEPT. ES351**  
SAINT PAUL 6, MINNESOTA

Please send copy of new booklet, "Tapes for Television."

Name \_\_\_\_\_

Firm \_\_\_\_\_

Address \_\_\_\_\_

City \_\_\_\_\_ Zone \_\_\_\_\_ State \_\_\_\_\_

REG. U.S. PAT. OFF.  
**SCOTCH**  
BRAND  
Electrical  
Tapes

The term "SCOTCH" and the plaid design are registered trade marks for the more than 100 adhesive tapes made in U.S.A. by Minnesota Mining & Mfg. Co., St. Paul 6, Minn.—also makers of "Scotch" Sound Recording Tape, "Underseal" Rubberized Coating, "Scotchlite" Reflective Sheeting, "Safety-Walk" Non-slip Surfacing, "3M" Abrasives, "3M" Adhesives. General Export: Durex Abrasives Corp., New Rochelle, N. Y. In Canada: Canadian Durex Abrasives Ltd., Brantford, Ontario.

which appeared in the April, 1950, issue of the *Military Amateur Radio System Bulletin*.

### Vibrator Power Supplies for Railroads

By L. R. THOMAS  
*Electronics Engineer*  
 Atchison, Topeka and Santa Fe Railway  
 Chicago, Illinois

TO OPERATE communication services on rolling stock and between rolling stock and fixed locations, the Atchison, Topeka and Santa Fe Railway Co. has installed vibrator power supplies working off the starting battery of diesel engines. By this means, direct voltages of 32, 64 and 110 volts are converted to 110-v 60-cycle alternating voltage.

The heart of the vibrator-inverter circuit, Fig. 1, is a tandem heavy-duty vibrator carrying four independent power-handling circuits and duplicate independent driving circuits. A spare vibrator is also included which is switched in automatically upon failure of the operating unit.

The vibrator uses precision-ground ceramic spacers and is shock mounted within its case to permit accurate functioning of the vibrator in any position and under extreme conditions of vibration, heat and shock. The vibrator is a plug-in type and is arranged on the equipment so that it is easily accessible when replacement is necessary.

Full use of the four power-handling circuits is available. Each contact pair is permitted to operate independently of the other contacts

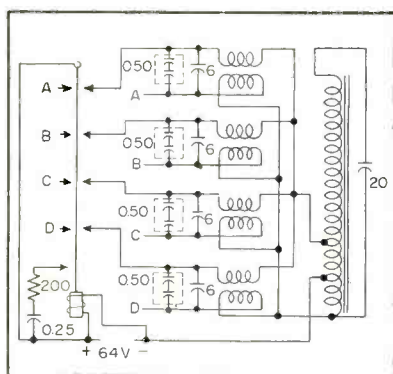

FIG. 1—Simplified schematic of the 64-v vibrator power supply showing the four independent power handling circuits. The auxiliary vibrator is connected in parallel with the one shown. Note the coupled reactors



HE CHOSE

# Magnecorder

THE FIRST CHOICE OF RADIO ENGINEERS

### FLEXIBILITY

In rack or console, or in its really portable cases, the Magnecorder will suit every purpose. PT6 Series shown is the most widely used professional tape recorder in the world, and is available with 3 3/4", 7 1/2", 15" if preferred.

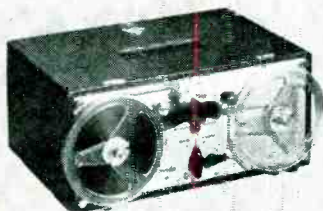

### FIDELITY

Lifelike tone quality, low distortion meet N.A.S. standards — and at a moderate price! PT63 Series shown in rack mount also offers three heads to erase, record, and play back to monitor from the tape while recording.

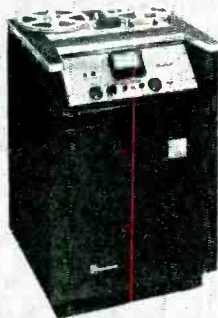
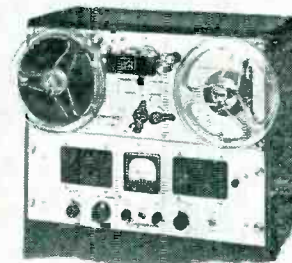

### FEATURES

PT7 accommodates 10 1/2" reels and offers 3 heads, positive timing and pushbutton control. PT7 Series shown in complete console model is also available for portable or rack mount. For outstanding recording equipment, see the complete Magnecord line — PT6, PT63 and PT7.

### WRITE FOR NEW CATALOG

Magnecord, Inc. Dept. EB-3  
 360 N. Michigan Ave., Chicago 1, Ill.  
 Send me latest catalog of Magnecord Equipment.

Name.....  
 Address.....  
 City..... Zone..... State.....

**Magnecord, INC.**

360 NORTH MICHIGAN AVENUE  
 CHICAGO 1, ILLINOIS



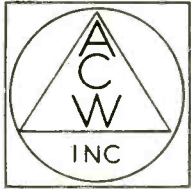

## ATLAS COIL WINDERS, INC.

STAMFORD

CONNECTICUT

CUSTOM WINDING

EXPERIMENTAL

ELECTRONIC SUB-ASSEMBLIES

To Meet

GOVERNMENT  
SPECIFICATIONS

## Boost Production OF ELECTRONIC OR ELECTRICAL ASSEMBLIES

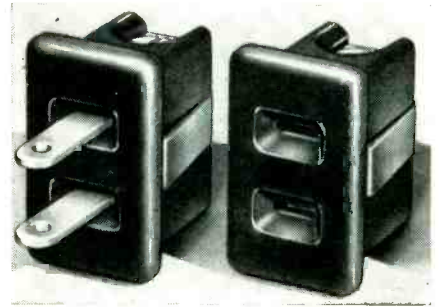

WITH



"DIAMOND H" SNAP-INS

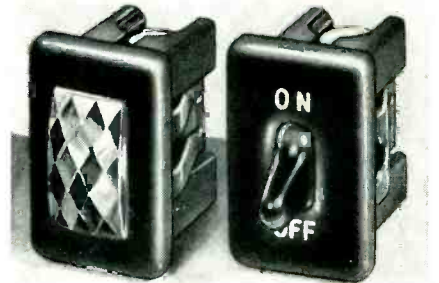

**\*Save Man Hours** — toggle switches, pilot lights, convenience outlets and inter-connecting load plugs just snap into their holes. Wire them up before or after. Spring clips hold them firmly and permanently. Wide flanges eliminate need for exacting tolerances in finish around installation holes.

**\*Get Peak Performance** — simple in design, rugged in construction, "Diamond H" Snap-Ins are built to give positive, un-failing action under demanding service conditions.

Switches, both single and double pole, have contacts held together under positive spring action in "on" position. Rated 12 and 20 A, 125 V; 10 A, 250 V, A. C., and also available with horsepower ratings. Pilots, rated 115 V or 230 V, A. C., have large faceted lenses to give greatest light output of any comparable pilots on the market. All available in black, white, brown or special color plastic.

*Write today for complete details.*

**THE HART MANUFACTURING COMPANY**

202 BARTHOLOMEW AVENUE  
HARTFORD, CONNECTICUT

## NOW! A Better Frequency Standard Crystal

THE  
**JK G-9**

- ★ Absolute Hermetic Sealing
- ★ Dependable Vacuum
- ★ Higher Q
- ★ No Supersonic Reflections
- ★ Greater Stability

**JAMES KNIGHTS** takes pride in presenting the JK G-9, first of a series of new crystals employing a glass envelope for absolute hermetic sealing. A dependable vacuum can be maintained, resulting in higher crystal Q and absolute freedom from the effects of supersonic reflections.

Although now available only in limited quantities and only in the 90 to 200 KC range, it is planned to use this mounting on higher frequencies.

Excellent thermal insulation is afforded by the glass and vacuum, utilizing the principle of the thermos bottle. In oven operation, for instance, a thermostat cycle of several degrees will result in a change of only a fraction of a degree at the crystal—providing stability never before possible!

**LESS CRYSTAL "AGING"**— Greater cleanliness is achieved in the new JK G-9 because glass is not porous and does not de-gas as does metal. Temperatures that would be destructive to the characteristics of a crystal are necessary for complete de-gassing of metal holders, whereas clean glass holders are relatively easy to de-gas. Because no fumes are emitted by the sealing operation, crystal "aging" is substantially reduced.

With minimum power dissipation, as employed in modern oscillator design, the new JK G-9 provides a new standard of stability plus years of trouble-free precision operation.

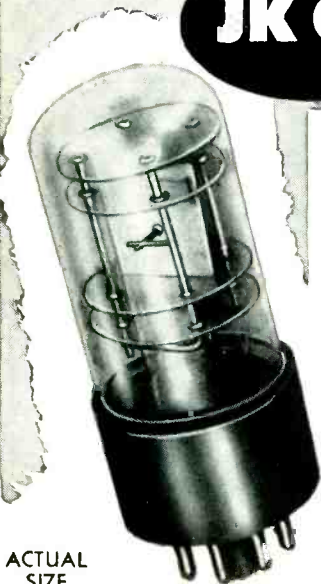

ACTUAL  
SIZE



*The James Knights Company*  
SANDWICH, ILLINOIS

Specify JK for civilian,  
military or amateur use!



## VIBRATION INDICATOR PROVES VALUABLE INSPECTION TOOL

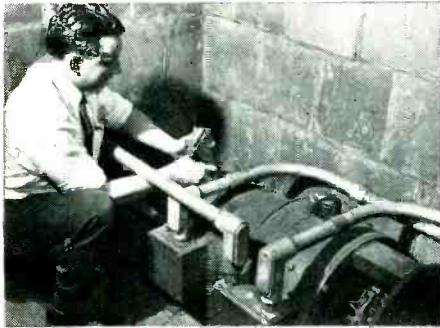

The Mutual Boiler and Machine Insurance Company of Boston, Massachusetts, established 1887, is now using the General Electric lightbeam-type vibration indicator extensively in its regular inspections of insured machinery. The company considers this easy-to-read and highly accurate ( $\pm 3\%$ ) indicator to be an important instrument in the \$1000 test kit used by its field personnel.

In general, every piece of rotating equipment insured by Mutual is given three inspections a year. Since excessive vibration in this type of equipment is one of the surest signs of trouble, it is a major consideration in determining whether a particular machine is a good insurance risk. Mutual's engineering department tries to maintain a vibration amplitude of not more than two mils as a standard for insured, high-speed rotating machinery.

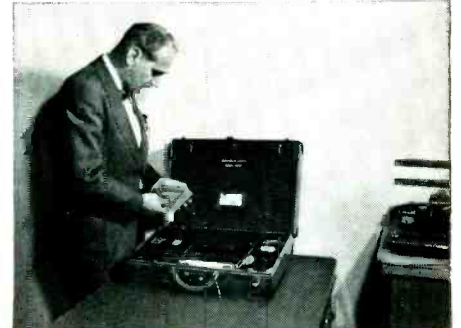

In making vibration measurements, Mutual frequently uses a mass/weight system. But in nearly all cases, the G-E vibration indicator is used as the final authority. Mutual engineers, reporting highly satisfactory results, say that the G-E vibration indicator has proved ideal for their purposes.

## G-E Magnetic Thickness Gage Aids Paint and Resin Studies

The General Electric Type B magnetic thickness gage, a portable instrument for measuring the thickness of nonmagnetic material on a magnetic surface, is now being used by the G-E Chemical Department in the development of new paints and alkyd resins for industrial finishes.

The gage is proving particularly valuable for checking and controlling the thickness of the many paint and resin samples constantly being tested. Since the tests are designed to reveal the wearing and covering characteristics of one sample in relation to the characteristics of the other samples, uniform sample thickness is essential.

With its high sensitivity, the magnetic thickness gage gives readings well within the required degree of accuracy. Because it measures magnetically, it does not in any way deface the samples. And because of its small size and light weight, it is always available for on-the-spot use.



## Carbon-arc Intensity Tests Made with Type C-E Recorder

In line with its policy of constantly searching for new ways to improve its products, the National Carbon Division of the Union Carbide and Carbon Corporation, New York, has for some time been using a General Electric Type CE photoelectric recorder in its carbon-arc intensity tests.

These tests, conducted at the National Carbon Research Laboratories, Cleveland, are designed to give precise indications, in microamperes, of the light intensities of various carbon arcs.

At one end of a twelve foot room, the illuminated carbon crater is placed in a test lamp directly behind a lens of 25.4:1 magnification (thus making one inch at the image equal to one millimeter at the source). At the opposite end of the room, a photocell, driven along a transverse rod by a small synchronous motor, picks up the arc light at different angles of deflection. The photocell is connected to the G-E photoelectric recorder, which writes a continuous and permanent record of light intensity.

The National Carbon Division chose the G-E recorder because of its extremely high sensitivity. In these tests, it can record intensities as low as 1 micro-

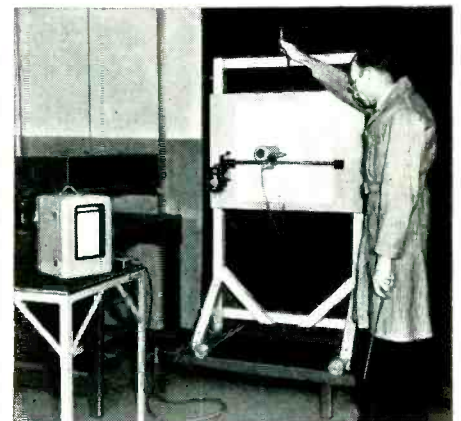

ampere and as high as 500 microamperes.

The G-E recorder weighs only 35 lbs. and is available for either portable use or semi-flush mounting. Its response can be as fast as  $\frac{1}{4}$  sec. for full-scale deflection.

# GENERAL ELECTRIC



602-199

SECTION A602-199  
 APPARATUS DEPARTMENT  
 GENERAL ELECTRIC CO.  
 SCHENECTADY, N. Y.

Please send me information on the following products:

Lightbeam-type vibration indicator (GEA-4140)  
 Type CE photoelectric recorder (GEC-254)  
 Type B magnetic thickness gage (GEC-319)

NAME .....  
 COMPANY .....  
 STREET .....  
 CITY ..... ZONE ..... STATE .....



## Arterial Blood Pressure

## or Guided Missile Acceleration

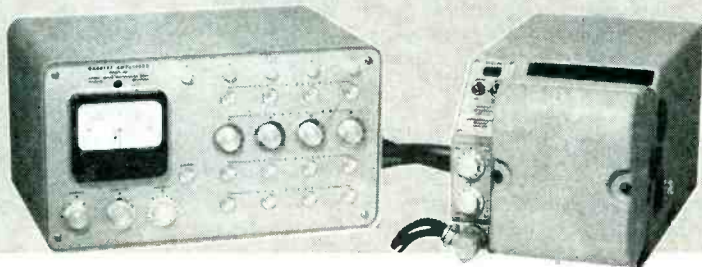

### *Consolidated's* **RECORDING SYSTEM E** *captures both for study and accurate analysis*



ITS GREAT VERSATILITY makes CEC's new Recording Measurement SYSTEM E of particular importance in today's expanding test and research programs. Its operation by inexperienced personnel is expedited by the highly simplified balancing-calibration procedures.

Consisting of a 5-116 Recording Oscillograph and 1-118 Carrier Amplifiers (9- or 14-trace) in any 4-channel multiple, SYSTEM E yields *permanent* records of phenomena up to 500 cycles per second. Even the most transient phenomenon may be recorded, measured, analyzed, evaluated.

SYSTEM E's wide range might well be the answer to your own instrumentation problems. A note to our Pasadena office will bring complete specifications.

*Ask for Bulletin CEC-1405-X2*



**CONSOLIDATED ENGINEERING CORPORATION**

*Analytical Instruments for Science and Industry*

620 NO. LAKE AVE.

PASADENA 4, CALIFORNIA

in assuming its share of the total load even though there may be an appreciable difference in exact time of closure of contact pairs which apparently are operating simultaneously. This is accomplished by each of the four side reed contacts operating through individual reactor windings which are coupled with the opposite side reed contact.

The vibrator is adjusted to provide 60-cycle operation  $\pm$  one-half cycle and output regulation is within  $\pm$  5 percent with an input voltage variation of 15 percent.

Automatic transfer from the operating vibrator to the spare unit is accomplished as follows: As soon as one of the pair of vibrator contacts has worn through the tungsten contact-facing material, operation of the contacts draws an arc from the soft metal backing supporting the contact surface. The arc builds up until one of the pair of contacts is welded together, which in turn shorts out the input and blows the input fuses. The transfer circuits are then set in operation and the effective vibrator is automatically removed from the power circuit. The new vibrator takes over after a protected period of several seconds provided by a relay.

The transformers and reactors in the unit are made with class-B insulating materials which permit continuous operation to temperatures as high as 150 C. All capacitors are oil impregnated and hermetically sealed.

#### *Vibrator Life*

The normal life of the vibrator in service on switch engines has been between 60 and 90 days on a 24-hour 7-day-per-week basis. The life on diesel road locomotives runs approximately 90 to 120 days because the units are turned off for greater lengths of time. Life of vibrators on cabooses has been about six months or greater.

Maintenance of the vibrator equipment is much less than that of the rotary inverter. An additional advantage is obtained in that service is never completely lost with this type of equipment. If the defective vibrator is replaced after the automatic switchover has been made the interruption to radio



**RAYTHEON**

fractional hp motors

**dependable performance**

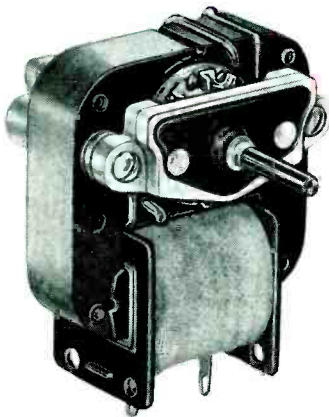

**TYPE 230 Shaded 2-pole Motor.** For continuous duty without fan cooling. 1/200 to 1/50 hp at 3200 rpm. Flat Speed Torque Curve and High Starting and Pull Up Torque are characteristic of all Type 230 Raytheon motors. Efficiency is almost double the value ordinarily obtained in shaded two-pole motors of this type. Write for Data Bulletin 1000.

"Count on Raytheon to run it." Design engineers have learned to rely on Raytheon fractional hp motors when they want to *run* things—for example, FANS, BLOWERS and AIR CONDITIONING EQUIPMENT.

Raytheon Creative Craftsmanship assures *Dependable Performance* at the shaft—the kind of trouble-free power unit that manufacturers need in today's competitive markets.

Call in your Raytheon representative for consultation on your specific application.



**RAYTHEON Type 470 Shaded 6-pole, 1050 rpm Induction Motor.**



**RAYTHEON Type 330-S Shaded 4-pole 1/200 to 1/10 hp 1550 rpm motor.**



**RAYTHEON Type 350 Shaded 2-pole, 1/40 to 1/6 hp at 3000 rpm motor.**



**RUSSELL ELECTRIC COMPANY**  
SUBSIDIARY OF **RAYTHEON** MANUFACTURING CO.

4501 So. Western Boulevard

Dept. C-24

Chicago 9, Illinois



# PRECISION POTENTIOMETERS

Various types of potentiometers custom wound to specifications are available. They feature extremely close limits in electrical characteristics and mechanical construction, low electrical noise, low torque, and long life.

All types will operate within specified limits of performance at temperatures  $-55^{\circ}\text{C.}$  to  $+55^{\circ}\text{C.}$ , 95% relative humidity at altitudes up to 50,000 feet. Corrosion resistant materials are used throughout and all insulating parts are fungicided. Our potentiometers meet AN-E-19 specifications.

We invite your inquiries and specifications.

Write for Bulletin F-68.

**THE GAMEWELL COMPANY**

Newton Upper Falls 64, Massachusetts

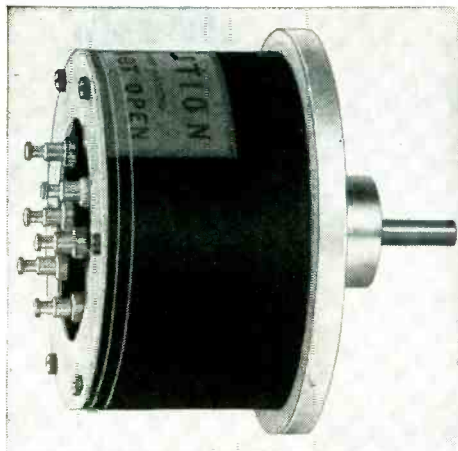

A minor modification of the standard sinusoidal potentiometer type RL-11-C (as illustrated) permits operation up to 1800 RPM. After a test of 28 million cycles at 1800 RPM, one of these units showed negligible wear.

# HOLTITE

Precision  
**FASTENERS**

for  
**ELECTRONIC ASSEMBLIES**



The uniform precision of HOLTITE fasteners meets the high standards demanded of component parts in the assembly of electronic equipment. Made of the highest grade, laboratory-tested materials, these accurate, rugged units are quality-controlled at every stage of production to insure smooth application and trouble-free performance.

HOLTITE screws are made in all types, sizes, metals (especially stainless steel) and finishes required in electronic equipment. Special fasteners are made, on order, exact to specifications, samples or prints.

Write for  
Type 1000  
Data Sheet

**CONTINENTAL  
SCREW COMPANY**  
New Bedford, Mass. U.S.A.

# 2 PURPOSE TELEDAPTER

- TELEVISION WAVE FORM OBSERVATION
- RADAR PULSE

LOW \$  
PRICED  
AT **195** F.O.B.  
PLANT

- Converts a DuMont 208 or 304 Scope for use with TV and Radar pulse type signals. Response 3 db down at 5 M.C.
- Completely self-contained including power supply. No modifications to the 208 or 304 Scope required.
- Size matches both Type 208 and 304 scopes and tie plates are furnished to fasten both instruments together.

Convert your Type 208 and 304 Scopes for TV and Radar testing, for only \$195.00

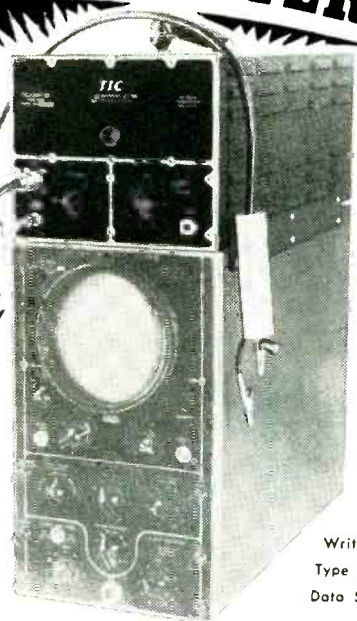

Manufacturers of a complete line of TV and Radar Test Equipment

**TIC**

**Tel-Instrument Co. Inc.**

50 PATERSON AVENUE • EAST RUTHERFORD, N. J.

# Trim Assembly Time with the Tube with the Tab

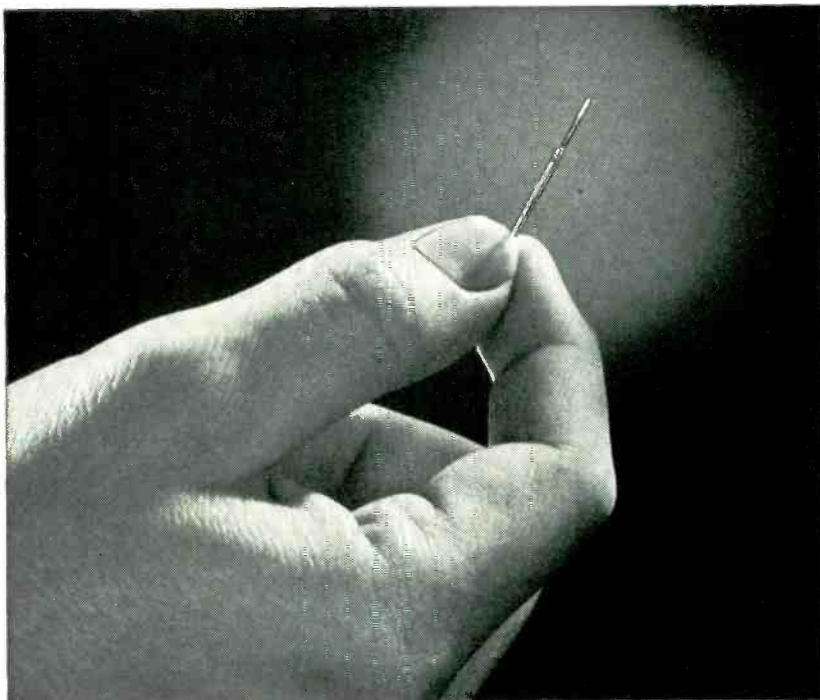

● Superior's pioneering in tubing technology is constantly at work to bring electronic manufacturers new developments—to help them produce better equipment, faster, at lower costs. Newest of these improvements is the integral tabbed round Lockseam\* cathode. It is designed to eliminate a welding operation, cut assembly time, and provide superior performance.

These integral tabbed round Lockseam\*cathodes may be valuable

to you . . . but whether they are or not one thing is sure. If you use Seamless or Lockseam\* cathodes in your product a Superior tube is available to do a Superior job. Our research and engineering facilities are ready at all times to help solve your tubing problems.

For more information about Superior Tubing and its possible place in your operation write to Superior Tube Co., 2500 Germantown Ave., Norristown, Pa.

## Which Is The Better For Your Product . . .

**SEAMLESS . . . ?** The finest tubes that can be made. Standard production is .010" to .121" O.D. inclusive, with wall thicknesses of .0015" to .005". Cathodes with larger diameters and heavier walls will be produced to customer specification.

**Or LOCKSEAM\* . . . ?** Produced directly from thin nickel alloy strip stock, .040" to .100" O.D. in standard length range of 11.5 mm to 42 mm. Round, rectangular or oval, cut to specified lengths, beaded or plain.

\*Mfd. under U. S. Pats.—SUPERIOR TUBE COMPANY • Electronic Products for export through Driver-Harris Company, Harrison, New Jersey.

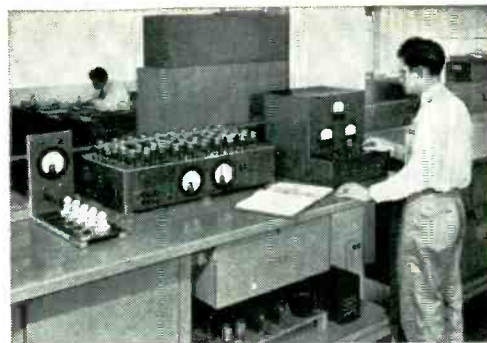

**Electronic Engineering** — Life test rack and emission test set. Checking Superior assembled standard diodes under simulated customer conditions to determine if material meets minimum requirements.

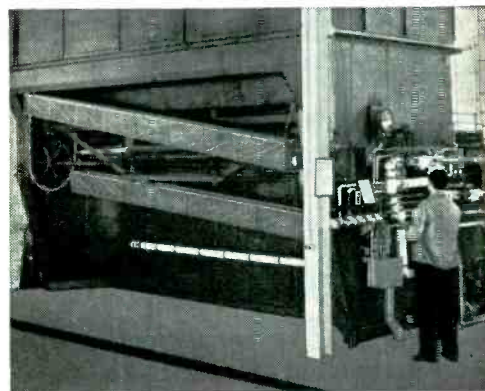

**To guard against** contamination by processing lubricants, Superior tubing is thoroughly degreased before each annealing operation.



**Part of inspection procedure** on Lockseam Nickel Cathodes as they come off the production machine. Each cathode must undergo many rigid tests before being approved.

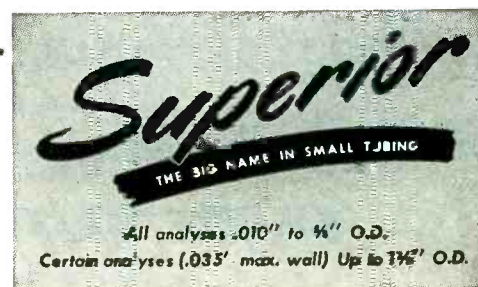



# "Controlled Reluctance"

MICROPHONES PROVED\* TO BE THE  
FINE-QUALITY-ECONOMICAL ANSWER TO  
MANY MICROPHONE PROBLEMS

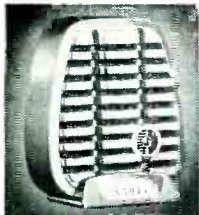

MODEL 510

The "HERCULES"—Here is a revolutionary new microphone that provides the ruggedness, the clear reproduction, and the high output long needed for public address, communications, recording at an amazingly low price! Can be placed on a desk, in the hand, or on a stand.

Model 510C . . . . . Code: RUTUF  
Model 510S (with switch) . . . Code: RUTUS



MODEL 520

The "GREEN BULLET"—Specially designed to provide quality music and speech reproduction at moderate cost. A streamlined unit that lends itself to fine-quality, low-cost installations where durability is an important factor. Features high output, good response, high impedance without the need of a transformer.

Code: RUDAL



MODEL 505

The "RANGER"—Recommended for those applications where long lines are used and a rugged hand-held microphone is needed. Ideal for outdoor public address, mobile communications, hams, audience participation shows, etc. Designed for clear, crisp natural-voice response of high intelligibility. Has heavy-duty switch for push-to-talk operation.

Model 505B (Medium Impedance) . Code: RUDAY  
Model 505C (High Impedance) . . Code: RUDAX



MODEL 520SL-7  
(7' cable)  
Code: RUDAN

The "DISPATCHER"—Complete dispatching unit. Designed to handle the most severe field requirements of paging and dispatching systems. Ideal for police, railroad, taxicab, airport, bus, truck and all emergency communications work. Operates both microphone and relay circuits. High output, high speech intelligibility. Unit is preassembled.

Model 520SL-20 (20' cable) . . . . Code: RUDAF

**CONTROLLED RELUCTANCE CARTRIDGE**—Available for service installation. Ideal for replacement of crystal cartridges in Shure cases of Models 707A, 708 and carbon cartridges in the 100 and "CB" series. Can also be used in most semi-directional microphones where space permits. Supplied with rubber mounting ring.

Code: RUTUC

\* Specific information provided on request.

Patented by Shure Brothers, Inc.

## SHURE BROTHERS, Inc.

Microphones and Acoustic Devices

225 West Huron St., Chicago 10, Ill. • Cable Address: SHUREMICRO



MODEL R5



TUBES AT WORK

(continued)

service is a matter of approximately one to two minutes for each vibrator failure.

### Facsimile Reproduction for AEC Library Service

FULL REFERENCE library service will be provided to outlying atomic research laboratories as a result of a new high-speed long-distance facsimile system recently installed at the Oak Ridge National Laboratories of the Atomic Energy Commission.

The new system, developed by the Radio Corporation of America Laboratories, incorporates several innovations in the field of facsimile reproduction. The reader-transmitter, Fig. 1, will scan printed copy or drawings on flat surfaces such as book pages and will make direct enlargements of material in small type by any ratio up to 4 to 1.

The copy bed can handle individual sheets or books up to three-inches thick. The signal is transmitted over an ordinary telephone line and the recorder will reproduce clear and legible black-on-white copy at a speed of 15 linear or 128 square inches per minute.

The new system promises to cut down expensive outlay for new books and will also prevent possible contamination of books and journals



FIG. 1—Reader-transmitter of the test model of the new RCA facsimile system being prepared for operation by Roger Olden, research engineer. Operation of the transmitter is monitored by the oscilloscope on the right panel



# CLEVELITE\* and COSMALITE\* PHENOLIC TUBING

MEETS THE MOST EXACTING SPECIFICATIONS!

**A GRADE FOR EVERY NEED:**

*Why Pay More?*

ALSO USED WIDELY BY MANUFACTURERS OF ELECTRICAL EQUIPMENT . . . FOR ITS HIGH DIELECTRIC STRENGTH . . . LOW MOISTURE ABSORPTION . . . STRENGTH, LOW LOSS AND GOOD MACHINABILITY.

AVAILABLE IN DIAMETERS, WALL THICKNESSES AND LENGTHS TO MEET ENDLESS SPECIAL OR NEW ADAPTATIONS.

INQUIRIES ARE GIVEN IMMEDIATE ATTENTION.

ASK FOR SAMPLES.



## CLEVELITE

- Grade E . . . . . Improved post cure fabrication and stapling.
- Grade EX . . . . . Special grade for TV deflection yoke sleeve.
- Grade EE . . . . . Improved general purpose.
- Grade EEX . . . . . Superior electrical and moisture absorption properties.
- Grade EEE . . . . . Critical electrical and high voltage applications.
- Grade XAX . . . . . Special grade for government phenolic specifications.

## COSMALITE

- Grade SP . . . . . Post cure fabrication and stapling.
- Grade SS . . . . . General purpose.
- Grade SSP . . . . . General purpose—punching grade.
- Grade SLF . . . . . Thin wall tubing—high dielectric and compression strength.

## CLEVELAND PHENOLIC TUBING

THE FIRST CHOICE OF THE RADIO AND TELEVISION INDUSTRIES.  
EXCELLENT SERVICE AND PROMPT DELIVERIES ASSURED.

\* Trade Mark

The CLEVELAND CONTAINER Co.

6201 BARBERTON AVE. CLEVELAND 2, OHIO

PLANTS AND SALES OFFICES at Plymouth, Wisc., Chicago, Detroit, Ogdensburg, N.Y., Jamesburg, N.J.  
ABRASIVE DIVISION at Cleveland, Ohio  
CANADIAN PLANT: The Cleveland Container, Canada, Ltd., Prescott, Ontario

### REPRESENTATIVES

- NEW YORK AREA R. T. MURRAY, 614 CENTRAL AVE., EAST ORANGE, N. J.
- NEW ENGLAND R. S. PETTIGREW & CO., 968 FARMINGTON AVE. WEST HARTFORD, CONN.
- CANADA WM. T. BARRON, EIGHTH LINE, RR #1, OAKVILLE, ONTARIO



MUREX introduce a new

Sintered  
COMPOSITE  
Magnet

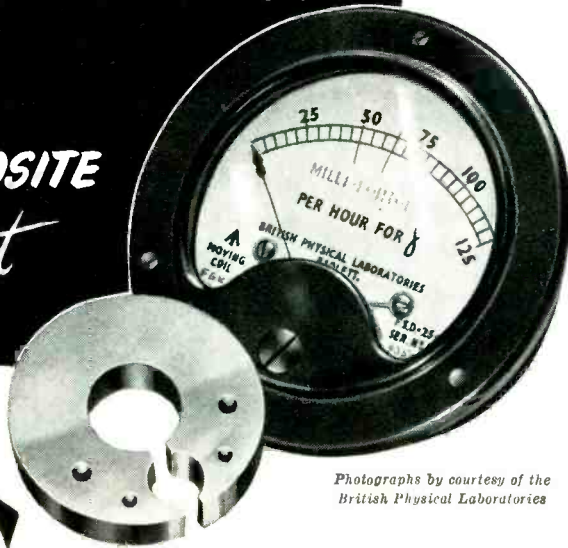

Photographs by courtesy of the  
British Physical Laboratories

PERMANENT  
MAGNET ALLOY  
MACHINEABLE  
SOFT IRON

Principal advantages are:—No necessity for separate pole-pieces • No assembly arrangements between magnet and pole-piece • Integral pole-piece and magnet means no loss of flux and no source of stray fields between magnet and pole-piece • A constant field in the gap • Greater flexibility of design and simplified assembly • Considerable saving in cost.

MUREX LTD. (Powder Metallurgy Division) • RAINHAM • ESSEX • ENGLAND  
London Sales Office: Central House, Upper Woburn Place, W.C. 1

# Measure Time Intervals



From 10 Microseconds to 3 Seconds

The time interval between any two components in electrical, mechanical or electro-mechanical systems can now be measured, simply and accurately, with American Chronoscope Equipment.

The Model 211 Input Adapter used in conjunction with the Model 110 American Chronoscope separates the functions of STARTING and STOPPING the measurement of time. Simply connect the Start and Stop leads from the adapter to any two components of a system under test. Only the first complete elapsed time interval presented is accepted. This reading is indicated on the Chronoscope and remains fixed until reset.

PRICES

Model 110 Chronoscope . . . \$475  
Model 211 Input Adapter . . . \$265

For complete description on these and other Chronoscopes and Adapters, write for Bulletin 200A



**American Chronoscope**  
CORPORATION  
316 WEST FIRST ST. MOUNT VERNON, N. Y.

# DUMONT

NEW  
IMPROVED  
TINYMITE

SMALLEST  
PRACTICAL MINIATURE  
PAPER CAPACITORS

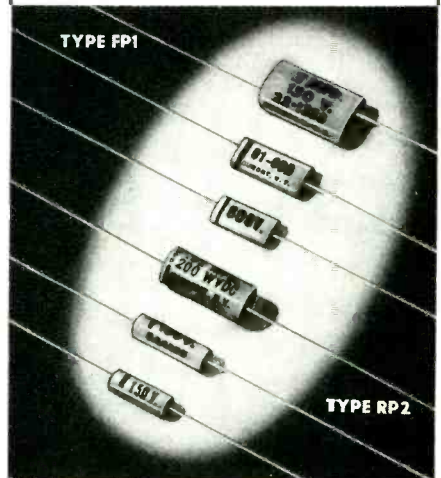

NOW  
FULLY MOULDED

HIGHLY  
MOISTURE PROOF

MEETS  
JAN IMMERSION TESTS

TYPE FPI (FLAT) WAXED COATED 85° C	TYPE RP2 (ROUND) WAXED COATED 85° C
---	--

CAP. from .00005 to 2.00 MFD  
VOLTAGE 50 V. to 600 V.

TYPE FPIV VARNISH COATED  
for 100° C.

TYPE RPIV  
VARNISH COATED for  
100° C.

SEND FOR  
SAMPLES  
AND  
LITERATURE.

FOR DEPENDABILITY ALWAYS  
SPECIFY DUMONT

# DUMONT

ELECTRIC CORP.

MFR'S OF  
CAPACITORS FOR EVERY REQUIREMENT  
308 DYCKMAN ST., NEW YORK, N. Y.

# Kahle equipment for manufacturing cathode ray, miniature, and sub-miniature tubes

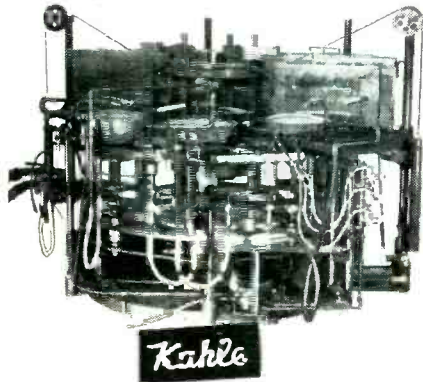
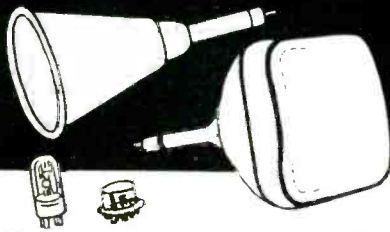

## FOR CATHODE RAY TUBES

### #1578 EIGHT-HEAD AUTOMATIC

Manual loading, unloading. Other operations automatic. Kahle Standard Barrel Cam Index, timer controlled. Dual motor drive. Capacity 60-90 per hr. Also single head.

### #1414 CATHODE RAY TUBE BUTTON STEM MACHINE

Turns out 400-500 TV stems per hr. Fine adjustment of speed, pressure, heat, sequence of operations. Labor saving development for automatic tubulation flaring.

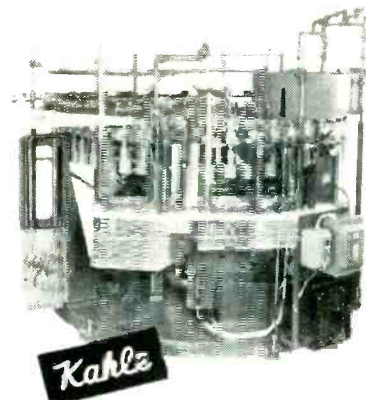
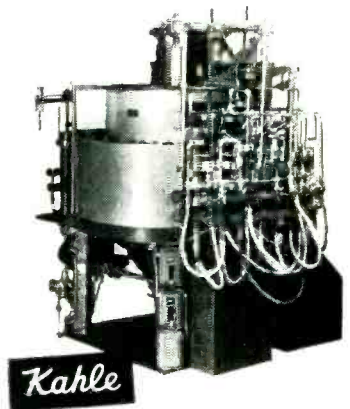

## FOR MINIATURE TUBES

### #1463 48-POSITION EXHAUST MACHINE

All degrees of operation from manual to completely automatic. Production limited only by pump equipment or loading speed of operator.

### #1197 24-HEAD BUTTON STEM MACHINE

For miniature and subminiature tubes. Two upper moulds for making non-tabulated stems with short lead wires. Dual motor drive. Cap. 1000 per hour.

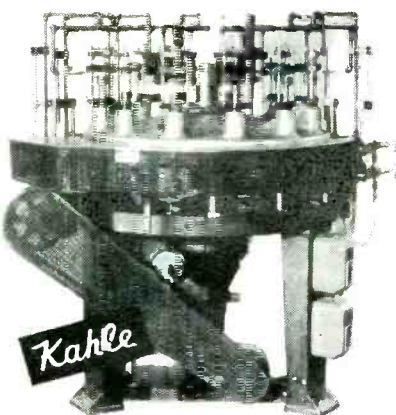
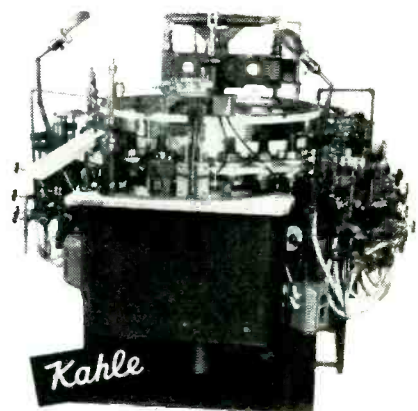

## FOR SUB-MINIATURE TUBES

### #1384 12-HEAD BUTTON STEM MACHINE

Button  $\frac{1}{4}$ " in diameter with 5 long wires. Hand loading and unloading. Dual motor drive. Available for any stems, any number of heads and automatic feeds.

### #1375 12-HEAD SEALING MACHINE

Also for hearing aid tubes. Kahle Standard Dual motor drive. Indexing by barrel cam and rollers. Heads have self-centering bulb holders.

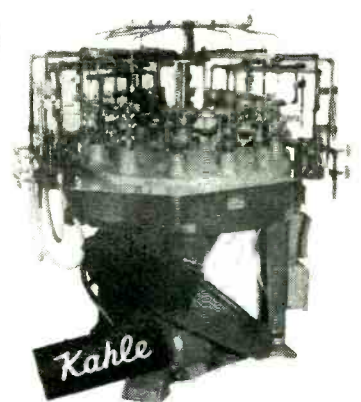

We welcome your consultation.  
Write for our new catalog.



**KAHLE ENGINEERING CO.**  
1309 SEVENTH STREET • NORTH BERGEN, NEW JERSEY



# TRANSFORMER CASES

TUBES AT WORK

(continued)

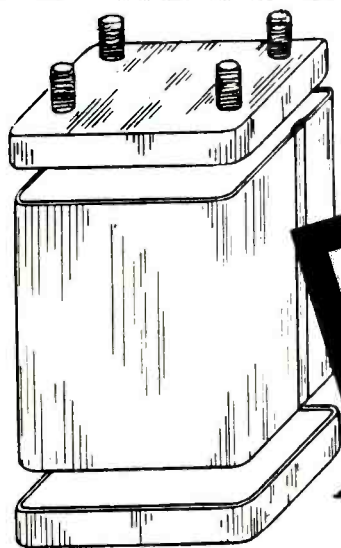

**MIL  
T-27**

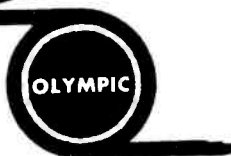

**HOT TINNED TO YOUR SPECIFICATIONS  
DRAWN CASES WITH INSIDE FIT COVERS  
IN SMALL SIZES**

**WRAPAROUND, LOCK SEAM CASES IN  
MEDIUM AND LARGE SIZES**

**OUTSIDE FIT DRAWN COVERS IN LARGE  
SIZES**

**CAREFULLY SELECTED STEEL FOR THE BEST  
COMBINATION OF STRENGTH, WEIGHT  
AND SPACE FACTORS**

**ROUNDED CORNERS FOR NEAT, STREAM-  
LINED APPEARANCE**

**SHIPMENTS FROM STOCK ON STANDARD  
STYLES**

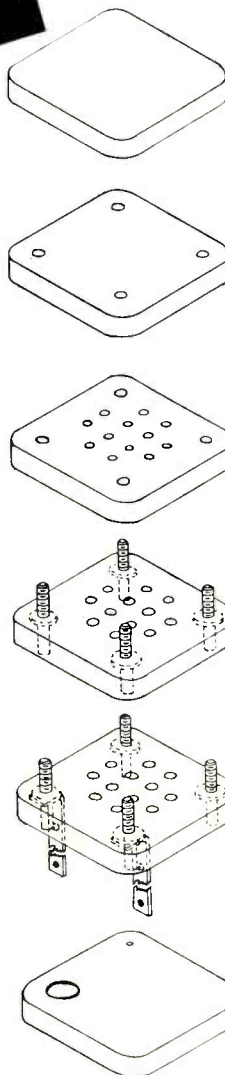

Standard cover modifications are illustrated above. Other modifications to meet your specifications.

# OLYMPIC

**METAL PRODUCTS COMPANY INC.  
P. O. Box 71 Phillipsburg, N. J.**



FIG. 2—Reproduced copy shown coming from the receiver unit of the system

in laboratories using radioactive materials.

The transmitter is located at the central library and the only operating recorder at present is located about eight miles away.

A cathode-ray flying-spot scanner at the sending unit employs a five-in. crt which directs a tiny spot of light through a focusing lens to read the copy. The reflected light from the copy is picked up by a bank of four multiplier phototubes which convert the varying light impulses into normal electrical facsimile signals.

The copy bed automatically moves the copy forward under the flying-spot crt. The length of the scanning line on the copy can be adjusted from 2½ in. to 8½ in. by a knob control. This control adjusts the lens to maintain the proper focus and changes the copy-bed speed to maintain the correct scale.

An electrolytic process is used in the recorder. The paper is moistened no more than is absolutely necessary and is completely dried as it passes out of the machine. Ultraviolet light fixes the chemicals so that neither the printing nor the background will fade. The clogging and corrosive action of the chemical solution is eliminated by keeping separate the two components of the solution until applied to the paper.

An intercommunication system set up with the equipment enables the operators of the transmitter and recorder to discuss the material as it comes over the wire.

Your sealed assemblies can be  
kept **TIGHT** with

# STUPAKOFF Kovar-Glass Seals

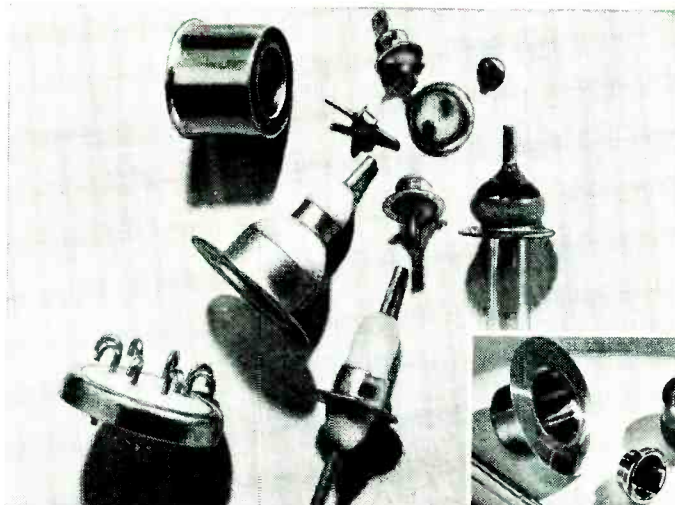

Stupakoff Metal-to-Glass Seals are made in a variety of sizes and ratings.



Kovar Metal, the ideal alloy for glass sealing, is furnished in the form of tubes, rods, sheet, foil and fabricated shapes.

Metal-to-glass seal making has been highly perfected by Stupakoff. When you specify Stupakoff Seals, you get well-designed, accurately-made products that are easy to assemble, mechanically strong, have high flashover ratings, provide high resistance to thermal shock and are dependable. They are made in a wide variety of standard types and sizes, or in special designs to meet your specific needs.

Stupakoff seals are all made with Kovar Metal, which is readily bonded with hard glass producing no undesirable structural stresses. It has substantially the same expansivity as hard glass from  $-80^{\circ}\text{C}$  to the annealing point of glass. These characteristics of Kovar make Stupakoff Seals dependable.

*Write for samples and prices of typical  
Stupakoff Kovar-Glass Seals.*

# STUPAKOFF

**CERAMIC & MANUFACTURING COMPANY**  
Latrobe, Pennsylvania

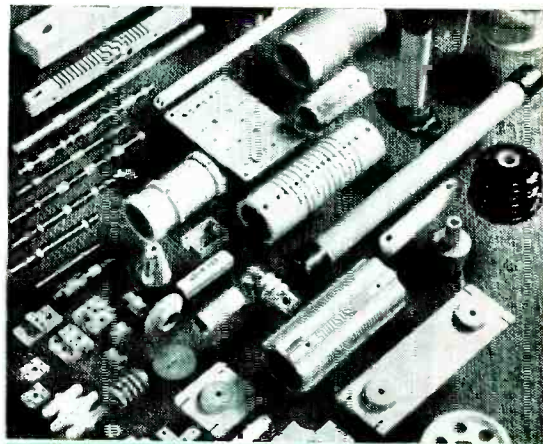

Representative Stupakoff Ceramic products

## STUPAKOFF PRODUCTS

*For Electrical and Electronic Applications*

**ASSEMBLIES**—Stupakoff assemblies include metallized ceramic Induction COILS for radio receivers and transmitters; metallized ceramic SHAFTS for air-tuning condensers; METALLIZED PLATES for making fixed rigid assemblies; ceramic trimmer condensers.

**CERAMICS**—Stupakoff has long been a leading supplier of ceramic products for a wide variety of electrical and electronic applications—precision made for all voltages, frequencies and temperatures.

**RESISTOR CERAMICS**—Stupakoff Temperature-Sensitive Resistors are used for temperature indicating or measuring equipment such as Radiosonde, for infra-red light source and for heating elements. Supplied complete with terminals, in the form of rods, tubes, discs, bars, rings, etc.

**STUPALITH**—A group of ceramics having remarkable ability to withstand extreme thermal shock. STUPALITH may be made to have zero, low-positive or low-negative expansivities. Formed by conventional methods. Safely used at temperatures up to  $2200^{\circ}\text{F}$ .

**CERAMIC DIELECTRICS**—Stupakoff makes general purpose Ceramic Dielectrics for by-pass, lead through blocking, stand-offs and trimmer applications. Temperature compensating Ceramic Dielectrics have coefficients from P-100 to N-2700, and high K materials up to K-6000.

Made in the form of tubes, discs and special shapes, plain or silvered. See photo below.





# THE OSCILLOSCOPE CAN Fool YOU!

It's no mean trick to keep an eye on 2, 4 or more oscilloscopes for simultaneous comparison. Worse yet may be the successive use of a single 'scope for the one-at-a-time study of different transients that should be compared simultaneously under identical conditions.

ETC Multi-Channel Oscilloscopes reduce these problems to their simplest form—by combining a number of wave forms on a single tube. Whether in equipment or material testing; in electroencephalography, neurophysiology or other medical research; in the field of explosives; in seismography or geology or in other critical applications it is thus entirely practical, infinitely more convenient and often far more accurate to observe different transients under exactly the same conditions or stimulus.

In addition to standard 2-, 4-, 5- and 8-channel 'scopes, ETC produces many special adaptations for specific uses.

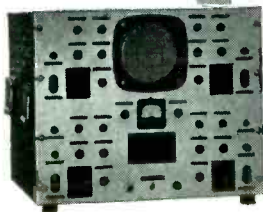

4-CHANNEL OSCILLOSCOPE, TYPE H-43. For recording through continuous strip cameras.

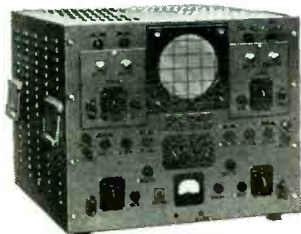

UNIVERSAL DUAL CHANNEL OSCILLOSCOPE, TYPE H-22. Plug-in a-c or d-c amplifiers. Registers from DC to 1 megacycle.



*electronic tube corporation*

PHILADELPHIA 18, PENNSYLVANIA

See us at Booths 274-275, I. R. E. Show

## THE ELECTRON ART (continued from p 142)

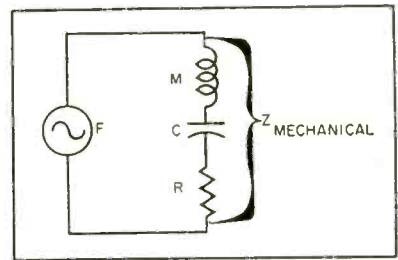

FIG. 1—Electrical analog of loudspeaker

which electrical circuit constants relate the current to the applied voltage. It is therefore possible to write the equation.

$$F = Z_{MECH} v$$

where  $F$  is applied force,  $v$  is velocity, and  $Z_{MECH}$  is the mechanical impedance, given in this particular case by

$$Z_{MECH} = R + j \left( \omega M - \frac{1}{\omega C} \right)$$

The force acting on the mechanical system is produced by the flow of current in the voice coil. On the other hand, motion of the voice coil in the magnetic field produces a counter emf in the electrical circuit which can be represented as a voltage drop across a fictitious impedance  $Z_{MOT}$  called the motional impedance.

From the electrical point of view it is therefore possible to draw an equivalent circuit as shown in Fig. 2. In this figure the amplifier is represented by an equivalent generator  $E$  in series with the effective internal impedance  $Z_i$ . The loudspeaker is represented by the electrical impedance of the voice coil  $Z_{vc}$  in series with the motional impedance. As will be shown,  $Z_{MOT}$  is

proportional to  $\frac{1}{Z_{MECH}}$  and therefore

has the characteristics of a parallel resonant circuit. It is convenient to lump  $Z_i$  and  $Z_{vc}$  into an equivalent driving source impedance  $Z_s$ . In general  $Z_s$  includes some reactance, but for the frequency range of particular interest the reactance is negligible compared to the resistance and can be ignored.

A more precise understanding of the effects of the electro-mechanical

<sup>1</sup> For a demonstration of this and an excellent discussion of electro-mechanical analogues see M. F. Gardner and J. L. Barnes, "Transients in Linear Systems", John Wiley and Sons, New York, 1942, Chapter II.

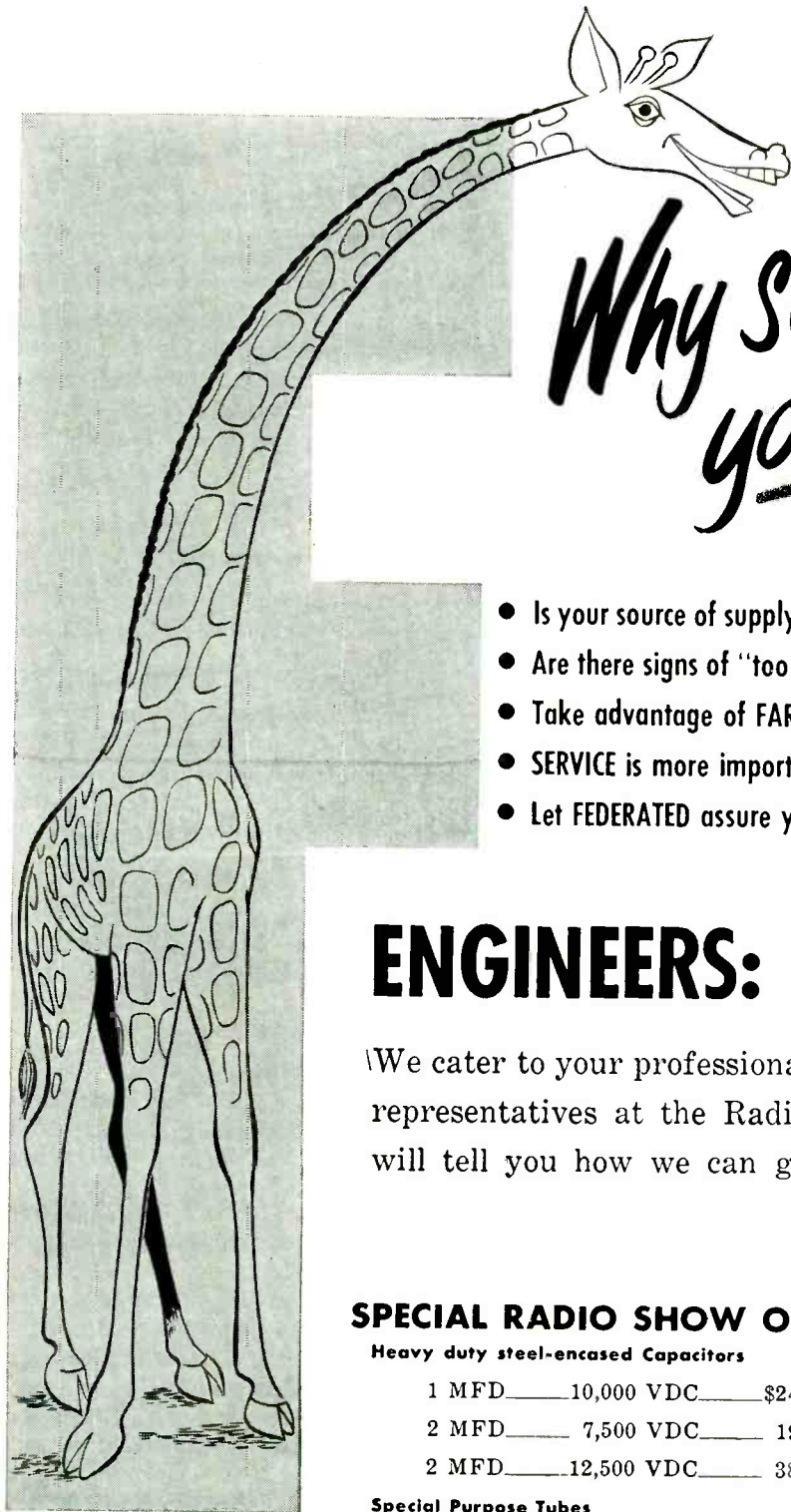

*Why stick  
your neck out?*

- Is your source of supply dependable in these times of critical shortages?
- Are there signs of "too little, too late"?
- Take advantage of FAR R-E-A-C-H-I-N-G Federated Purchasing Power!
- SERVICE is more important than ever—now!
- Let FEDERATED assure your smooth flow of electronic supplies.

## ENGINEERS:

We cater to your professional requirements. Talk to our representatives at the Radio Engineering Show. They will tell you how we can give you specialized service.

### SPECIAL RADIO SHOW OFFER

#### Heavy duty steel-encased Capacitors

1 MFD	10,000 VDC	\$24.00
2 MFD	7,500 VDC	19.50
2 MFD	12,500 VDC	38.00

#### Special Purpose Tubes

WL 655/658 (Westinghouse)	\$95.00
WL 652/657 (Westinghouse)	42.00
827 R (RCA)	59.00

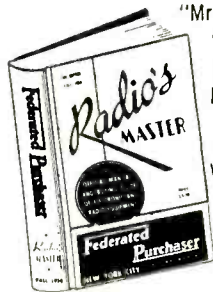

"Mr. Fed" says:  
"You get this  
1200-page  
Reference Manual  
**FREE**  
with your order."



CABLE: FEDERPURCH

# Federated Purchaser

INCORPORATED  
ELECTRONICS DISTRIBUTORS

66 DEY ST., NEW YORK 7, N. Y. Dlgy 9-3050

ALLENTOWN, PA.      NEWARK, N. J.      EASTON, PA.  
1115 HAMILTON ST.      114 HUDSON ST.      701 NORTHAMPTON ST.

Get it faster—the **FP** way! Put your name on our mailing list by writing us on your letterhead.



"LOOK, SAM,  
MEETING TOUGH TEST SPECS  
IS NO PROBLEM NOW ...  
EVEN ..."

# No. 41065-B

(U. S. A. F.)

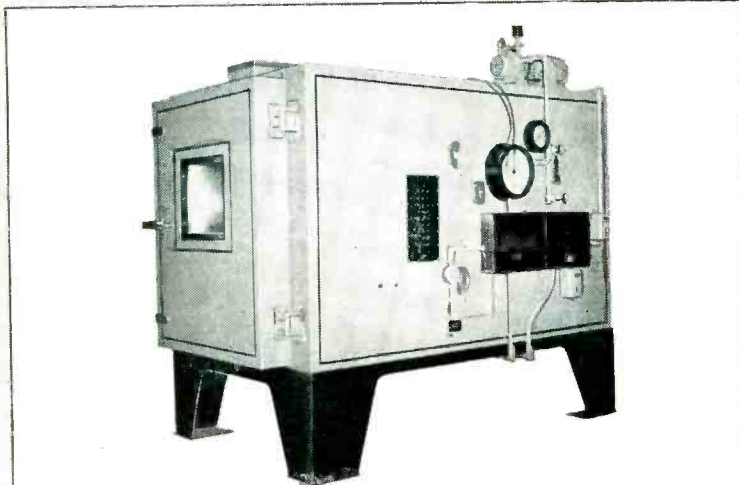

The TenneyZphere Altitude Chamber shown here was built to run environmental tests on aircraft electrical components, in accordance with 41065-B. Conditions met: Group 10 (high temp. tests), Group 20 (low temp. tests), Group 30 (humidity tests), and Group 40 (high altitude tests). Specified range from  $-103^{\circ}\text{F.}$  to  $+200^{\circ}\text{F.}$  Relative humidity—20% to 95%. Altitudes to 85,000 ft. Sizes from 3 cu. ft. to walk-in rooms.

Experience, hard and practical, is the reason why Tenney can build test chambers to meet the toughest industrial and government specifications. Standard Tenney units accurately control mildew resistance, altitude, explosion-proof, liquid immersion and other tests. Basic systems can be combined for complex conditions. Tenney program control assures absolute fidelity in changing times and conditions; electronic controllers provide high precision regulation. For literature and further information, write to Tenney Engineering, Inc., Dep't. A 26 Avenue B, Newark 5, New Jersey.



# Tenney

Manufacturers of Automatic Temperature,  
Humidity and Pressure Control Equipment

7154

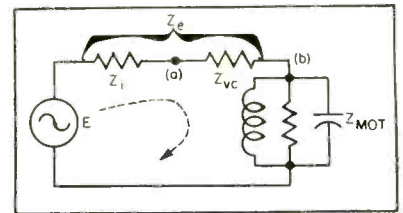

FIG. 2—Equivalent circuit of loudspeaker and driving amplifier

coupling between the mechanical system of the speaker and the electrical circuit of the amplifier and voice coil can be gained by considering the following equations.

$$Z_i i + \frac{Bl v}{10^8} = E \quad (1)$$

$$Z_{MECH} v = \frac{Bl}{10} i \quad (2)$$

Equation 1 is the voltage equation in the electrical circuit. The term  $\frac{Bl v}{10^8}$  is the counter emf produced by the motion of the voice coil of length 1 cm in a magnetic field of strength  $B$  gauss with velocity  $v$  cm per sec. Equation 2 is the force equation of the mechanical system; the term  $\frac{Bl}{10} i$  is the force in dynes exerted by the voice coil carrying  $i$  amperes. By solving for  $v$  in Eq. 2 and substituting in Eq. 1 we have

$$Z_i i + \frac{B^2 l^2}{10^9 Z_{MECH}} i = E \quad (3)$$

Equation (3) is the basis of the equivalent electrical circuit of Fig. 2. The second term on the left shows that  $Z_{MOT} = \frac{B^2 l^2}{10^9 Z_{MECH}}$ , and confirms our earlier statement concerning the nature of  $Z_{MOT}$ .

Although the effects of the driving source impedance  $Z_s$  can be analyzed from the electrical point of view shown in Fig. 3, it is more profitable to make the analysis from an equivalent mechanical point of view. If Eq. 1 is solved for  $i$  and the result substituted in Eq. 2 we obtain, after rearranging

$$Z_{MECH} v + \frac{B^2 l^2}{10^9 Z_s} v = \frac{Bl}{10 Z_s} E \quad (4)$$

This equation serves as the basis of the mechanical equivalent circuit of Fig. 3, in which the driving amplifier is represented as a force source of magnitude  $\frac{Bl E}{10 Z_s}$  in series with an effective internal impedance  $Z_s = \frac{B^2 l^2}{10^9 Z_s}$ .

There are several reasons for

One of a series of messages to design engineers to show how the General Electric specialized plastics molding service offers important advantages to selected industries.



# Specialized MOLDING SERVICE

## PRODUCES RUGGED, ATTRACTIVE TV CABINETS AT LOW COST!

When a design engineer needs large, molded plastics parts, the General Electric plastics molding service offers him the most modern techniques and facilities for their low-cost mass production.

For example, G.E. turns out thousands of eye-appealing, rugged one-piece plastics cabinets for large television manufacturers. These low-cost units are just one of the parts G.E. molds for the television industry. Plastics speaker grills, cabinet fronts, record-changer bushings, dials, knobs, and escutcheons are also produced economically by G.E.

General Electric's large molding plants employ the latest and most efficient equipment . . . new injection machines capable of molding parts up to 208 ounces per shot are now being installed. Many industries consider the G-E plastics molding service an important adjunct to their own assembly lines.

Depend on General Electric plastics engineering experience and production facilities for top-quality plastics molding and extruding—at low cost. For information, write to Section B-1, Chemical Department, General Electric Co., Pittsfield, Mass.

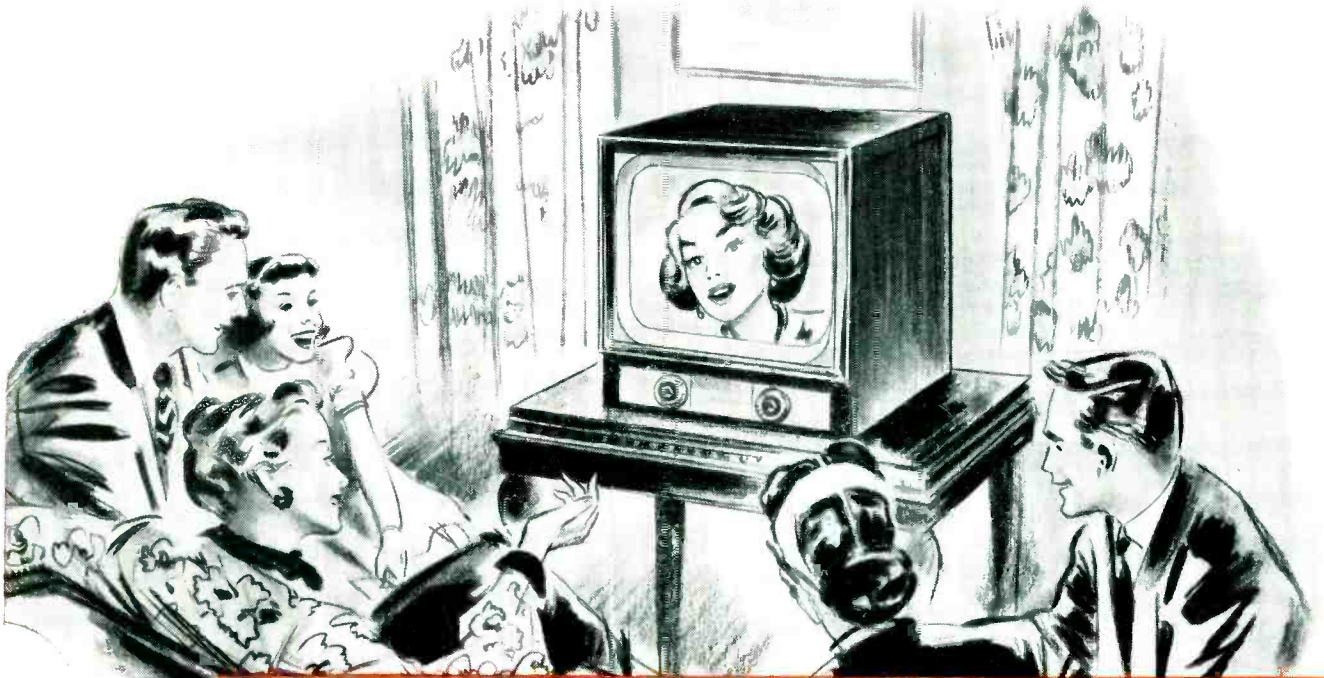

### G.E.'S SPECIALIZED MOLDING SERVICE IS GEARED TO INDUSTRIES LIKE THESE:

Television & Radio  
Refrigerator

Air Conditioning  
Washing Machine

Automotive  
Small Appliance

*You can put your confidence in*

**GENERAL  ELECTRIC**



# RECTIFIER TUBES

RUGGEDIZED BY  
**ECLIPSE-PIONEER**  
FOR ADDED RELIABILITY

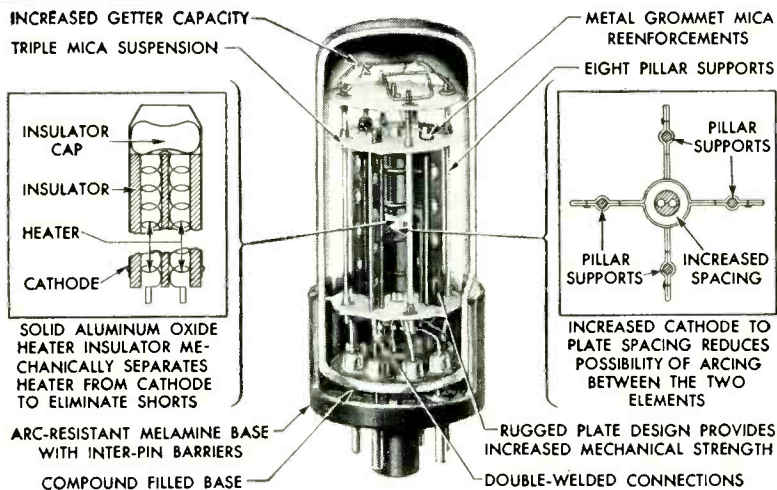

We are not in the standard vacuum tube business, but we are in the business of developing and manufacturing a reliable line of special purpose electron tubes—tubes that will serve and meet the stiff and varied operational requirements of aviation, ordnance, marine and other fields of modern industry. Typical of these are receiving type tubes such as Beam-Power Amplifiers, R-F Pentodes, Twin Triodes, and the Full-Wave Rectifiers illustrated above and described

below. All of these tubes are exhausted on a special automatic exhausting machine capable of extra high evacuation, and are aged under full operating and vibration conditions for a period of 50 hours. In addition to the tubes described above, Eclipse-Pioneer also manufactures special purpose tubes in the following categories: gas-filled control tubes, Klystron tubes, spark gaps, temperature tubes and voltage regulator tubes.

LOOK FOR THE PIONEER MARK OF QUALITY  
REG. U. S. PAT. OFF.

### Electrical Characteristics of E-P Full-Wave Rectifier Tubes

TUBE TYPE	R.M.A. 5838	R.M.A. 5839	R.M.A. 5852	R.M.A. 5993
Heater Voltage . . . . .	12 volts	26.5 volts	6.3 volts	6.3 volts
Heater Current . . . . .	0.6 amps.	0.285 amps.	1.2 amps.	0.80 amps.
Peak Inverse Voltage . . . . .	1375 v. (max.)	1375 v. (max.)	1375 v. (max.)	1250 v. (max.)
Peak Plate Current (per plate)	270 ma. (max.)	270 ma. (max.)	270 ma. (max.)	230 ma. (max.)
D-C Heater-Cathode Potential	450 v. (max.)	450 v. (max.)	450 v. (max.)	400 v. (max.)
Cathode Heating Time . . . . .	1 min.	1 min.	1 min.	45 sec.
Total Effective Plate Supply Impedance . . . . .	150 ohms (min.)	150 ohms (min.)	150 ohms (min.)	150 ohms (min.)

Other E-P precision components for servo mechanism and computing equipment:

- Synchros • Servo motors and systems • rate generators • gyros • stabilization equipment • turbine power supplies and remote indicating-transmitting systems.

For detailed information, write to Dept. C

**ECLIPSE-PIONEER DIVISION of**  
TETERBORO, NEW JERSEY



Export Sales: Bendix International Division, 72 Fifth Avenue, New York 11, N. Y.

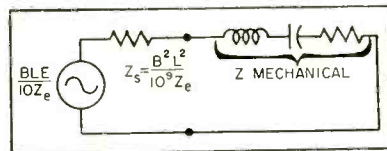

FIG. 3—Equivalent mechanical circuit of loudspeaker and driving amplifier

considering the speaker system from the mechanical rather than the electrical point of view. These are first, that speakers of comparable size all have approximately the same mechanical characteristics; second, that the magnetic gap strength and effective driving source impedance are conveniently accounted for because they effect only the element  $Z_s$ ; and third, that the effects of baffles are most simply considered from the mechanical point of view. For example, a simple enclosure merely increases the effective stiffness and can be considered as a series capacitor in the mechanical circuit.

In calculating the response of a loudspeaker by means of the circuit of Fig. 3 it must be remembered that the radiation resistance of a speaker in an infinite baffle or enclosure increases as the square of the frequency over the range of frequencies for which the speaker diameter is small compared to the wavelength. Most loudspeakers operate in this region for a range of several octaves in the vicinity of the resonant frequency. The low frequency response of a loudspeaker in an infinite baffle has been calculated for several different values of the impedance  $Z_s$ , and plotted in the curves of Fig. 4. The curves, which can also be applied to a speaker in a simple enclosure, give response as a function of the frequency relative to the resonant frequency. The magnitude of  $Z_s$  is given in terms of  $X_B$ , the reactance at resonance of the reactive elements in Fig. 3.

The curves of Fig. 4 indicate how important the impedance  $Z_s$  is in determining the response of loudspeakers. Curve A corresponds to a very small value of  $Z_s$ , and a mechanical Q of 10 for the speaker. The small value of  $Z_s$  might be the result of either a small value for  $Bl$  or a large value of  $Z_e$ . It is the type of response encountered, for example, when pentode tubes are

# IT'S "LOADED" WITH BETTER TELEPHONE SERVICE



*Twenty of the Bell System's newest small loading coils—like the one at the left—are housed in the long black case, mounted in a cable splice. This type of installation permits the economical extension of city cables to serve out-of-town subscribers.*

MANY more wires can be crowded into a cable sheath when the wires are fine. But normally, wires don't transmit as well when they are fine and closely packed.

Bell engineers long ago learned to make wires do better work by loading them with inductance coils at regular intervals. The coils improve transmission and let messages travel farther. But originally the coils themselves

were large, heavy and expensive. The cases to hold them were cumbersome and costly too.

So year after year Bell scientists squeezed the size out of coils. To make magnetic cores of high permeability they developed Permalloy. Tough but extra-thin insulation permitted more turns to a core.

New winding machines were developed by the Western Electric Com-

pany. Coil size shrunk to one-fiftieth. Some—like the one shown above—can be mounted right in cables themselves.

The 15,000,000 coils in the Bell System today mean thinner wires, more wires in a cable—more economical service for you. They demonstrate once more how Bell Telephone Laboratories work continually to add to your telephone's value.



## BELL TELEPHONE LABORATORIES

WORKING CONTINUALLY TO KEEP YOUR TELEPHONE SERVICE BIG IN VALUE AND LOW IN COST





### C.T.C. can get you "out from under!"

Long experience with the ever-increasing, constantly changing government specifications for electronic components has gained C.T.C. nationwide acceptance as a supplier to manufacturers handling U. S. contracts — especially for the armed forces.

With complete, up-to-date facilities for manufacturing electronic components in production quantities, C.T.C. meets the most exacting government standards for materials, tolerances, finishes, moisture prevention, anti-fungus treatment and similar requirements the government demands in the units you make.

Years of designing and manufacturing to government specifications enable us to handle *your* problems and save you time, money and worry! So, if "spec" problems are getting you down, why not unload them on recognized experts?

#### Here's What C.T.C. Can Furnish:

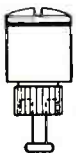
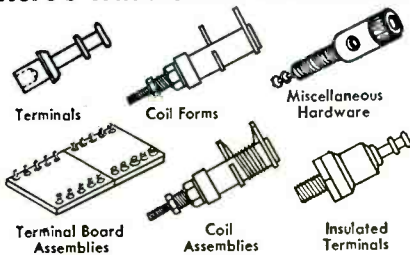

#### Have You Seen This C.T.C. Combination Terminal?

With a screw on top and a terminal lug on the bottom, this combination simplifies top and

bottom wiring. Remove the screw and you can mount components directly to the screw end. Or you can adapt terminal to provide removable link connections at screw end. Unit is plated with bright alloy for corrosion resistance and easy soldering. Shank heavily knurled for secure mounting. Comes in three sizes. Send for more information.

#### SPECIAL CONSULTING SERVICE

To aid you in securing exactly the *right* components to meet the requirements of your designs, prototypes, etc., C.T.C. maintains a staff of thoroughly experienced component engineers. These experts will work closely with you for the most economical and satisfactory results — and where standard parts are not suitable will design special units. *This service is always available to you — without cost!*

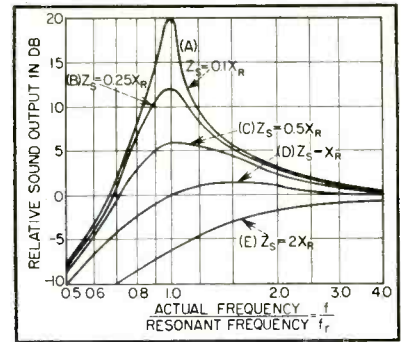

FIG. 4—Relative response of loud-speaker for different values of driving source impedance

used in the driving amplifier and no inverse feedback is employed to reduce the effective internal impedance. The pronounced peak in the response curve is responsible for the poor reproduction of transients which is sometimes described as poor speaker damping. The curves make it obvious that for uniform response and clean reproduction of transients the impedance  $Z_s$  should be quite high. This makes it imperative that  $Z_s$  be low. Triode tubes, when used in the output stage, provide a source of relatively low impedance, and this is one reason for the traditional preference for triodes. When using triodes the load is usually matched to the tubes in such a manner that the impedance looking back into the amplifier from the speaker is approximately equal to the voice coil resistance. Thus the impedance  $Z_s$  is equal to twice the voice coil resistance. By using pentode or beam tetrodes with sufficient negative voltage feedback it is possible to make the effective output impedance of the amplifier small compared to voice coil resistance. Thus  $Z_s$  can be made approximately equal to  $Z_{vc}$ . In other words, the speaker damping of pentodes with sufficient feedback is twice as good as that of triodes without feedback.

Since ordinary methods never permit the impedance  $Z_s$  to be reduced below the value of the voice coil resistance, the maximum value which can be achieved for  $Z_s$  is limited by the value of  $BL$ . For speakers with small magnetic structures this maximum value is still too low to result in appreciable improvement in the response obtained with a very high value of  $Z_s$ . Even

**CAMBRIDGE THERMIONIC CORPORATION**  
 437 Concord Ave., Cambridge 38, Mass.

Please send me:

More information on how C.T.C. can lighten my "spec" load.

More information on C.T.C.'s cooperative engineering service.

More information on the following C.T.C. products:

.....

Name..... Position.....

Firm.....

Street.....

City..... Zone..... State.....

*custom or standard the guaranteed components*

**C.T.C.**

# R & I E

**ISOLATED PHASE  
HEAVY DUTY BUSES  
FOR Consolidated Edison  
ARE INSULATED WITH**

**NATVAR  
VARNISHED BIAS  
TAPE**



A completed portion of metal enclosed bus and switches shows how neat and compact the 3500 Ampere Isolated Phase Bus installation is at Consolidated Edison's Waterside No. 1 station.

Insulator ring support section and 3500 Ampere conductor taped with Natvar V C tape as in the Isolated Phase Bus installation in Consolidated Edison's Waterside No. 2 station. Insulators are always under compression.

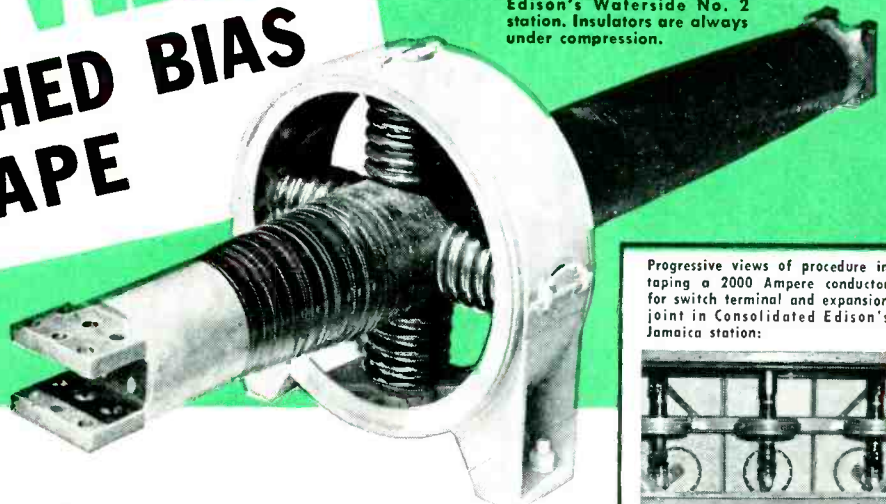

Progressive views of procedure in taping a 2000 Ampere conductor for switch terminal and expansion joint in Consolidated Edison's Jamaica station:

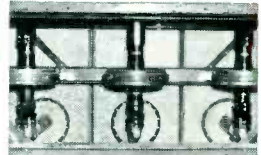

Partly taped section of conductor held by insulator ring support.

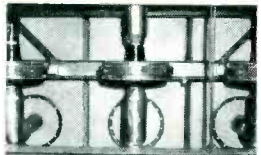

Taping shield installed over flexible connection, ready for final taping.



Taping completed. Bus is now ready for metal enclosure.

**M**etal Enclosed Isolated Phase Bus structures built for Consolidated Edison Co. by Railway and Industrial Engineering Co., Greensburg, Pa., for high voltage, high capacity, call for high reliability in service, a minimum of maintenance and a compact yet flexible arrangement. Each system is designed for its specific installation, and completely fabricated at the factory for final assembly on the job.

Component parts and materials must be of top quality. Conductors are taped with Natvar varnished bias tape because of its uniformly good electrical and physical properties.

Natvar flexible insulation is available either from your wholesaler's stocks or direct from our own.



**Natvar Products**

- Varnished cambric—straight cut and bias
- Varnished cable tape
- Varnished canvas
- Varnished duck
- Varnished silk
- Varnished special rayon
- Varnished Fiberglas cloth
- Silicone coated Fiberglas
- Varnished papers
- Slot insulation
- Varnished tubings and sleeveings
- Varnished identification markers
- Lacquered tubings and sleeveings
- Extruded vinyl tubing and tape
- Extruded vinyl identification markers

Ask for Catalog No. 21

**THE NATIONAL VARNISHED PRODUCTS**

Telephone  
Rahway 7-8800

Cable Address  
NATVAR: Rahway, N. J.

*Corporation*

201 RANDOLPH AVENUE ★ WOODBRIDGE, NEW JERSEY



Worth considering  
on any  
mechanical control  
problem

## S.S. WHITE FLEXIBLE SHAFTS

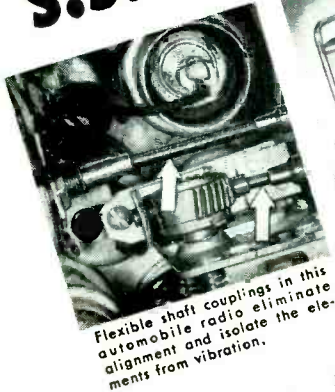

Flexible shaft couplings in this automobile radio eliminate alignment and isolate the elements from vibration.

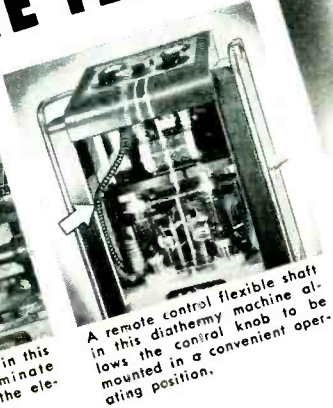

A remote control flexible shaft in this diathermy machine allows the control knob to be mounted in a convenient operating position.

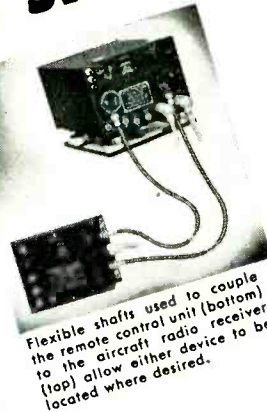

Flexible shafts used to couple the remote control unit (bottom) to the aircraft radio receiver (top) allow either device to be located where desired.

When you are working out a method of controlling electronic equipment, either manual or automatic, it will pay you to consider S.S. White remote control flexible shafts. These highly adaptable mechanical elements are built specifically for this service. And they offer the following basic advantages.

1. They allow you to locate variable elements exactly where you want them for optimum circuit efficiency, space saving, and ease of assembly, wiring and servicing.
2. They allow the control knobs or control unit to be mounted in the most convenient operating position.
3. They are quickly and easily installed, require no alignment and provide a smooth and responsive control that's good for the life of the equipment.



WRITE FOR NEW BULLETIN 5008

It contains the latest information and data on flexible shafts and their application. Write for a copy today.



THE **S.S. White** INDUSTRIAL DIVISION  
DENTAL MFG. CO.



Dept. E, 10 East 40th St.  
NEW YORK 16, N. Y.

with speakers having the largest magnetic structures supplied in the standard lines, the maximum value of  $Z$ , which can be obtained is still considerably below the optimum value for the speaker in an infinite baffle. Thus, curve *B* corresponds closely to the response in an infinite baffle of an eight-inch speaker with a 6.8-oz. Alnico V magnet and a 3.2-ohm voice coil when driven by an amplifier with triodes in the output. It is apparent that optimum response, if achieved by conventional methods, requires the use of an amplifier having sufficient negative voltage feedback to reduce the internal impedance to a negligible value, and in addition, the use of a larger magnet than is obtainable in speakers of moderate cost. Investigation has also revealed that optimum values of  $Z$ , for other baffles require larger magnetic structures than can be obtained in even the more expensive speakers.

The foregoing discussion indicates that a method for increasing the value of  $Z$ , which does not require the use of excessively large and expensive magnetic structures would be of considerable value. The remaining portion of this paper outlines such a method.

### Motional Feedback

Optimum response requires that for most speakers  $Z_e$  be made smaller than the voice coil resistance. Inspection of Fig. 2 makes it obvious that negative voltage feedback, applied in the customary fashion, cannot reduce  $Z_e$  below  $Z_{ec}$ . In conventional feedback amplifiers the feedback voltage is taken from point *a* in Fig. 2 and acts to reduce  $Z_e$  only. If a feedback voltage could be taken, instead, from point *b*, or from directly across the motional impedance, then  $Z_{ec}$  would be included in the feedback loop along with  $Z_e$ , and  $Z_e$  could then be reduced to any desired value. In other words, the feedback voltage must be a motional voltage.

The author has accomplished the result mentioned above in a very simple manner by winding a separate feedback coil of very fine wire over the existing voice coil in a conventional speaker. The voltage

# Brainwork for defense



**GUIDED MISSILES** using brain work for defense—  
provide protection against attacking enemy aircraft.  
Designed and “flight-proven” by Fairchild, this  
surface-to-air missile is another development  
geared to the requirements of our Armed Services.

Homing on radar impulses reflected by attacking  
aircraft, these missiles improve in accuracy as  
they approach their objectives.

Designed and built by the Fairchild Guided Missiles  
Division working closely with the Navy Bureau of  
Aeronautics and Naval Research Laboratories,  
this is an example of combining the practical and  
theoretical to obtain superior results.



ENGINE AND AIRPLANE CORPORATION  
**FAIRCHILD**

*Guided Missiles Division*

FARMINGDALE, N. Y.

Other Divisions: Fairchild Aircraft Division, Hagerstown, Md.  
Fairchild Engine Division, Al-Fin Division and Stratos Division, Farmingdale, N. Y.



Check, Grade,  
or Sort up to  
17 capacitors  
per minute

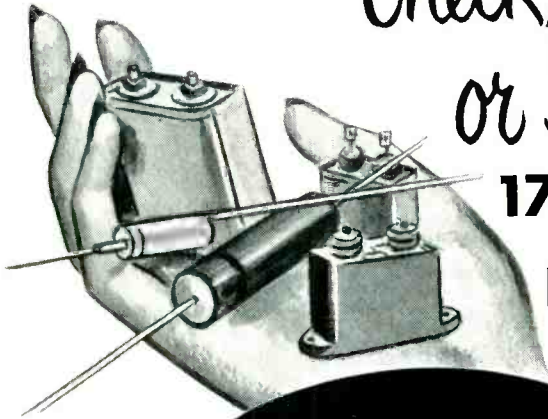

PRICE  
\$525.00  
F.O.B. CINCINNATI

with the New **Clippard PC-4**  
CAPACITANCE COMPARATOR

Any type of condenser . . . paper, mica, oil filled, ceramic or electrolytic . . . can be graded on the PC-4 at rates up to 8000 per day by an unskilled operator. Working to an accuracy of 0.2%, the PC-4 is a companion production instrument to the famous PR-5 Automatic Resistance Comparator. Leading manufacturers have found it an indispensable tool in the fight for higher quality and lower production costs. Easy operation reduces inspection time to an absolute minimum.

Completely self-contained, the PC-4 requires no outside attach-

ments other than the Standard Capacitor against which the unknowns are to be checked. Operates on 110 Volt—60 cycle AC. Range: 10 mmfd to 1000 mfd. Size: 18" x 12" x 12". Weight: approximately 35 lbs. For complete details, write for Catalog Sheet 3-E.

**Clippard**

INSTRUMENT LABORATORY INC.

1125 Bank Street • Cincinnati 14, Ohio

MANUFACTURERS OF R. F. COILS AND ELECTRONIC EQUIPMENT

induced in this coil by the motion of the voice coil is a pure motional voltage at most frequencies. This voltage, used as a feedback voltage, permits reducing  $Z_e$  below  $Z_{ec}$ . The method has the additional advantage of including nonlinearities of the cone suspension in the feedback loop and reducing distortion from this cause. Also, by proper design of the feedback coil, nonlinearities due to fringing of the magnetic field are included in the feedback loop and the accompanying distortion reduced with no loss in magnetic efficiency of the speaker.

At very high audio frequencies some difficulty is caused by the mutual inductance between the driving voice coil and the pickup coil. The mutual inductance produces in the feedback voltage a component which is dependent on the induction between the coils rather than on the motion alone. This voltage of induction is very small at most frequencies but becomes quite large at the higher frequencies, and, unless compensated for, results in attenuation of high frequencies. This difficulty is overcome by placing additional mutual inductance of opposite sign between the voice coil and feedback circuits at a point external to the magnetic field. Voltages of induction which are equal and of opposite sign are thus produced in the feedback circuit and cancel, leaving a pure motional voltage as the feedback voltage. It is therefore possible to design as a unit an amplifier-speaker combination, such as the one shown in Fig. 5, of superior performance. Table I, which is included for reference, lists for five typical speakers mechanical and magnetic data necessary to such a design.

In summary, the method presented furnishes a means of achieving excellent performance

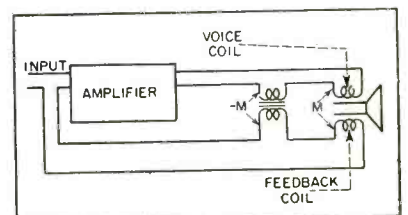

FIG. 5—Block diagram of amplifier-speaker combination with motional feedback compensating mutual inductance



Specify  
**FIBERGLAS\***  
 When you order  
**LAMINATES**

... because

*Sheets, Rods, and Tubes formed of Fiberglas glass-base laminates*

Along with the entire electrical industry, Owens-Corning Fiberglas Corporation is faced with increasing civilian and military demands. While we cannot now supply all the materials our customers want, we are substantially increasing our production facilities. Therefore, we believe it to your future best interests to consider this new and recommended use of Fiberglas yarns.

- generally resist high temperatures
- have excellent moisture resistance
- good strength/weight ratio
- excellent space factor
- high impact resistance
- and may be fabricated for a wide range of electrical and mechanical properties



\*Fiberglas is the trade-mark (Reg. U. S. Pat. Office) of Owens-Corning Fiberglas Corporation for a variety of products made of or with glass fibers.

OWENS-CORNING FIBERGLAS CORPORATION • Textile Products Division, Dept. 860 • 16 East 56th Street, New York 22, N. Y.



# Are you safe?



**WHY WORRY?** Let Victoreen's three old stand-bys . . . stand-by to protect you.



Proteximeter Model 300

**AREA SAFE?** Victoreen's area monitor; the Proteximeter for visual indication of accumulated scattered radiation up to 200 milliroentgens. No cords to stumble over; the Proteximeter's self contained batteries last long, cost little. Buy the finest and be sure; Victoreen's Proteximeter.

**YOU SAFE?** Personally yours, a Victoreen pocket chamber clipped beside your fountain pen goes everywhere you do . . . and tells the story. With one Minometer, and a pocket chamber for each worker you know the daily dosage.

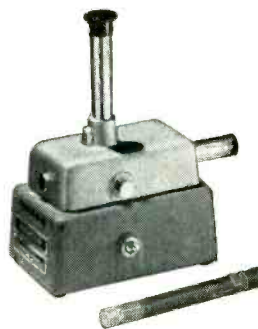

Minometer Model 287

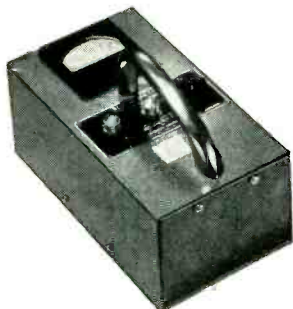

Alpha Meter Model 356

**ALPHA SAFE?** Alpha particles do not penetrate very far, but they contaminate just the same. Erroneous results, especially in delicate tracer and isotope work, may result from alpha contamination. Be sure with a Victoreen Alpha Meter.



## Victoreen

5806 HOUGH AVE. • CLEVELAND 3, OHIO

from speakers of low cost. The addition of the pickup coil to the voice coil structure at the time of manufacture should add very little to the cost, and result in negligible change in the mechanical characteristics of the speaker.

### Voltmeter-Ammeter for Determining Characteristics of Nonlinear Devices

BY FRED J. LINGEL

*Commercial Equipment Division  
General Electric Company  
Electronics Park  
Syracuse, New York*

NONLINEAR DEVICES, such as germanium diodes and varistors, can not be evaluated by resistance measurements made by a simple ohmmeter or resistance bridge, because the resistance of the element depends on the current flowing during the test. A voltmeter-ammeter resistance measuring setup is thus indicated.

With the voltmeter across the unknown resistance in the usual setup, the current indicated includes that taken by the voltmeter. In order to reduce this current it has been common practice to use a vacuum-tube voltmeter. This method is satisfactory for rough measurements but it is not readily adapted to precision measurements because of the inherent instability of the vacuum-tube voltmeter, the effects of line voltage, and the relatively short scale. These difficulties are especially noticeable in attempting to evaluate diode performance and drift in terms of small changes re-



Photograph of author using precision resistance-measuring equipment

# New Book Tells How to **SPEED URGENT PRODUCTION!**

*Get complete  
precision stamping service!*

*Use specially  
engineered parts!*

*Select correct  
type fastenings!*

*Reduce machine  
bottlenecks!*

*Simplify assembly  
methods!*

*Counsel with  
experienced assembly  
specialists!*

*Eliminate  
unnecessary  
operations!*

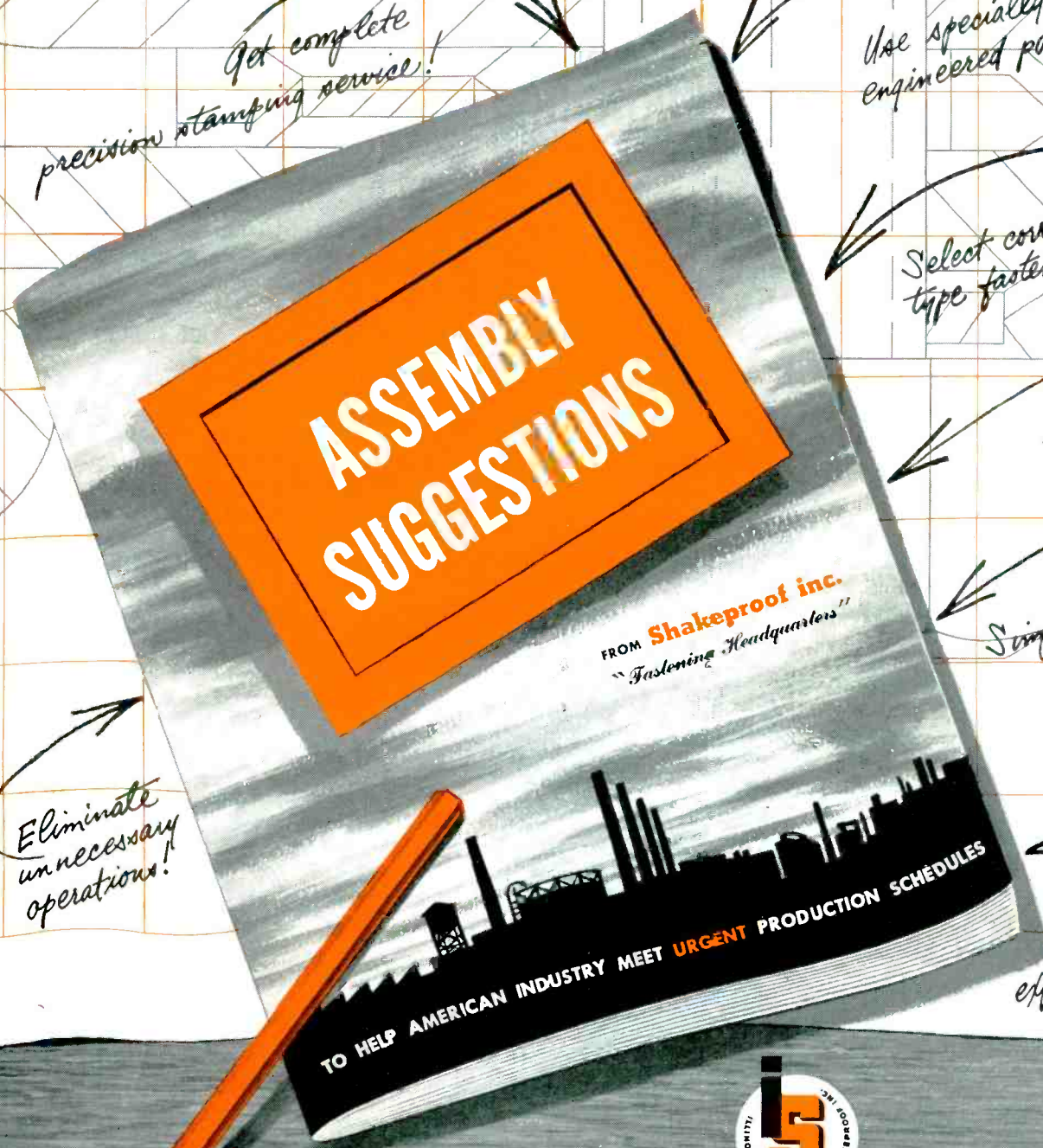

TO HELP AMERICAN INDUSTRY MEET URGENT PRODUCTION SCHEDULES



WRITE FOR YOUR  
FREE COPY TODAY!

## Shakeproof inc.

*"Fastening Headquarters"*

Division of Illinois Tool Works  
2501 North Keeler Avenue, Chicago 39, Illinois  
In Canada: Canada Illinois Tools, Ltd., Toronto, Ontario



# Here may be the answer to your RECORDING problem

Sanborn Amplifier Recorders are being found outstandingly useful in a wide variety of industrial recording applications. Records are produced *directly*, and continuously, by *heated stylus* on plastic coated record paper (Permapaper), are in *true rectangular* coordinates, and are sharp, clear, and *permanent*. Elimination of the *ink flow* type of recording permits the use of these recorders in any position and at any angle. The writing arm (or arms) is driven by a D'Arsonval moving coil galvanometer with an extremely high torque movement (200,000 dyne cms per cm deflection).

**The single channel Model 128** is a vacuum tube recording voltmeter capable of reproducing electrical phenomena from the order of a few millivolts to more than 200 volts. Standard paper speed is 25 mm/sec. Slower speeds of 10, 5, and 2.5 mm/sec. are available. A variety of interchangeable amplifiers is available.

**The multi-channel Model 67** provides for the simultaneous registration of *up to four* input phenomena on one record using, in a multiple system, the same principles and methods as the single channel Model 128.

In addition, this vertically mounted, metal cased amplifier-recorder provides a choice of eight paper speeds: 50, 25, 10, 5, 2.5, 1.0, 0.5 and 0.25 mm/sec., and further provides for the use of 4-, 2-, or 1-channel recording paper. Complete versatility of recording is offered in this unit by means of interchangeable amplifiers which permit the registration of stresses, strains, velocities, etc., along with the usual D.C. or A.C. phenomena.

*The recorder and amplifier units of which the above models are comprised are also available separately.*

For complete catalog giving tables of constants, sizes and weights, illustrations, general description, and prices, address:

**SANBORN COMPANY**  
Industrial Division  
CAMBRIDGE 39, MASS.

## SANBORN AMPLIFIER- RECORDERS



MODEL 128  
SINGLE  
CHANNEL

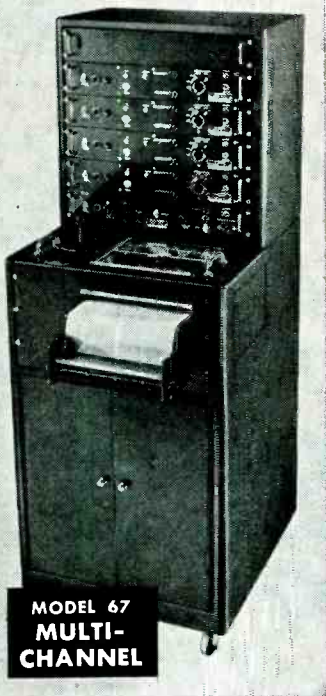

MODEL 67  
MULTI-  
CHANNEL

Sanborn Recorders and Amplifiers have evolved from those originally designed by Sanborn Company for use in electrocardiographs, and have, by actual practice, proven to have wide applications in the industrial field as well.

sulting from temperature and humidity.

Connecting the voltmeter across both the milliammeter and the unit under test is not satisfactory either because it is then necessary to subtract the milliammeter resistance from each measurement.

The equipment described in this article was developed to eliminate all of the above difficulties. Resistance is obtained directly from the voltmeter and milliammeter readings using the proper scale multiplying factors. A laboratory standard d-c voltmeter, GE Type DP-2, is connected directly across the diode under test. The current taken by this voltmeter is balanced from the current indicating meter by means of a special bridge circuit. With this method it is possible to work directly from 0.1 percent, laboratory standard type meters, using a long scale for high reading accuracy along with a knife edge type mirror scale. The value of each range resistor is determined by substitution using precision laboratory resistance boxes. After all values are established, resistors of the proper value are obtained and wired into the circuit. The complete unit should be checked with standard resistors in the unknown position, and minor resistance adjustments made as necessary.

The basic circuit of the instrument is shown in Fig. 1.

The ratio of current through the unknown resistor *X* to that in the galvanometer circuit is a constant and is independent of the unknown resistance. The direction of the current flow for the polarities chosen may be neglected at this point. The current through the

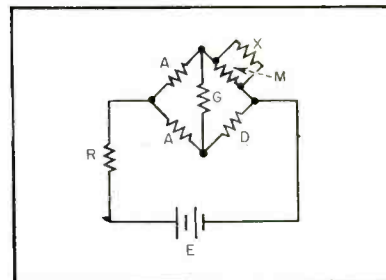

FIG. 1—Basic circuit of precision voltmeter-ammeter for determining characteristics of nonlinear devices under various operating conditions

**YOU ARE IN  
GOOD COMPANY...**



ABOVE: Compact speed control built by General Radio Co., Cambridge, Mass. for applications requiring up to approx. 1/15 H.P. output. Employs Seletron miniatures.

RIGHT: Internal grinder produced by Bryant Chucking Grinder Co., Springfield, Vt., equipped with 3/4 H.P. D.C. motor. Seletron power stacks, suitable for operation on standard A.C. current are incorporated into design of machine.

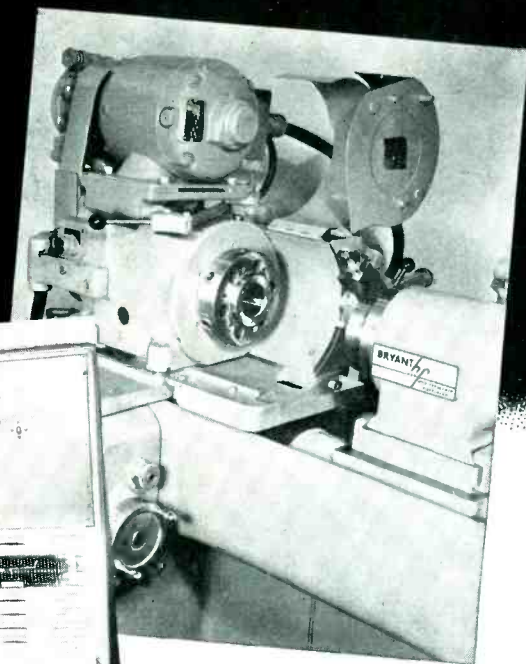
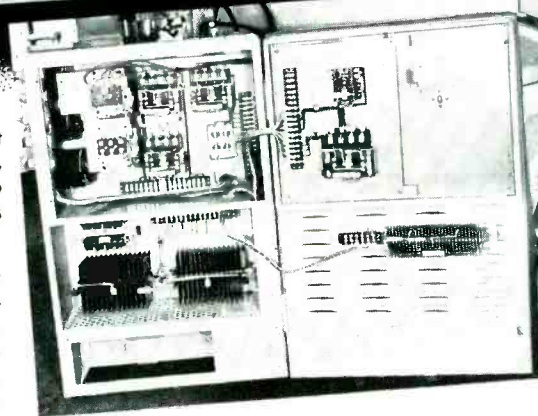

when **SELETRON** selenium rectifiers are "at the controls" for variable speed D.C. motor operation

## Seletron makes them ALL . . . Large, Medium and Small!



ABOVE: Elevator rectification — 3 bank power supply and regenerative braking equipment employing Seletron, built for Clinton Realty Co., Chicago, by Ther Electric & Machine Works.

There is a dependable SELETRON selenium rectifier for economical conversion of alternating current to D.C. for all requirements. SELETRON rectifiers have proved their efficiency and adaptability through the years in a wide range of industrial applications and electronic circuits.

Let SELETRON engineers help solve your rectification problems as they have for so many other ranking companies. Write now! Make sure to request a copy of our comprehensive bulletin No. ES-37.



SELETRON DIVISION

**RADIO RECEPTOR COMPANY, Inc.**

 Since 1922 in Radio and Electronics 

Sales Dept: 251 West 19th St., New York 11, N. Y. Factory: 84 North 9th St., Brooklyn 11, N. Y.  
See us in our Booth N-16 at the IRE Show



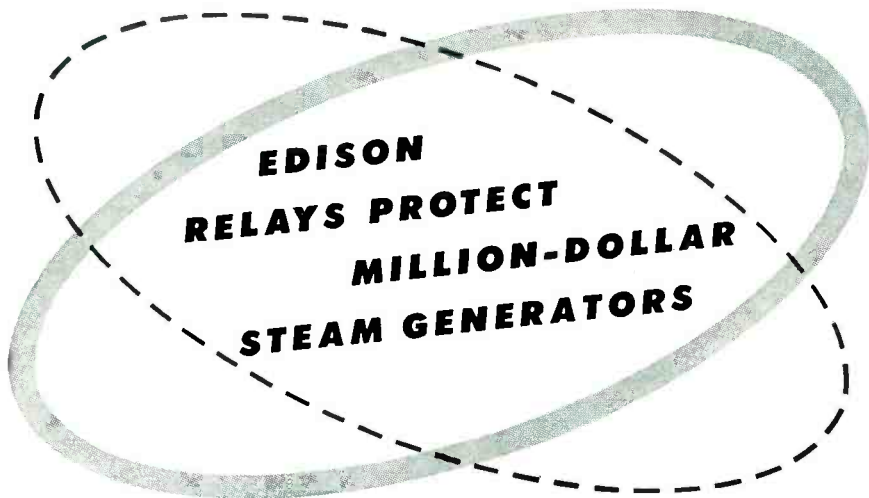

Combustion Engineering-Superheater, Inc. selects two types of Edison Relays for the important pilot-torch control cabinet used in their new large steam generators for public utilities.



Edison Sensitive Magnetic Relay. Operates on current generated by thermocouple in combustion chamber of pilot torch.

**Here's How They Work:** Though large public utility steam generators of this type usually burn powdered coal, oil-burning pilot torches are used to start and, at low loads, maintain combustion of the coal stream, which is blown in by air. In this application a remote push-button operates solenoid valves to turn on the oil and air supplies, and also closes the ignitor-spark power supply circuits. When the oil torch has been ignited, current generated by a thermocouple in the combustion chamber directly activates an Edison Sensitive Magnetic Relay which turns off the ignitor-spark power supply, and lights a remote "All Clear" signal lamp.

If the oil flame is extinguished for any reason, an Edison Time Delay Relay comes into play. Located in the control circuits for the oil-air supply, this relay delays shutdown of the air supply for a few seconds and thus permits "scavenging" of any unignited fuel oil which might otherwise foul the pilot torch.

**How About YOUR Circuit Control Problems?**

This particular application may help "spark" some solution to control circuit problems you may have on the board right now. In any case, you'll need more specific information; Bulletin 3004D covers the Edison Sensitive Magnetic Relay in detail; Bulletin 3009 describes the Edison Thermal Delay Relays. We'll be happy to send either or both on request.

92 Lakeside Avenue, West Orange, New Jersey



Edison Thermal Delay Relay. Delays shutoff of air supply on shutdown.

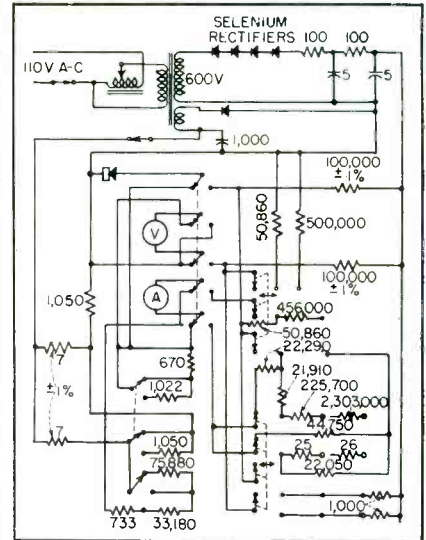

FIG. 2—Complete circuit of precision wide-range resistance measuring device

galvanometer can be determined by the following equation:

$$I_g = \frac{I_x}{2 + \frac{I_x}{G(A + M)}} \cdot \frac{A}{M}$$

where *M* is the resistance of the voltmeter.

This shows that the minimum full scale current obtainable is twice the normal full scale rating of the milliammeter. It is approached when the milliammeter resistance *G* is low and both the arm resistance *A* and the meter resistance *M* are large.

The complete circuit diagram of the instrument, with appropriate switching and power supplies is shown in Fig. 2. Two units of this type have been constructed for use in our laboratory. The first of these has been in constant service since November 1949 with very satisfactory results. One of the most important features of this equipment is the ability to measure trends in diode behavior in a relatively short time. This helped a great deal in aging and humidity cycling studies.

Considerable help in working out the mathematical proof of the validity of this method was given by N. De Wolf of this section.

**Compact Digital Differential Analyzer**

ENGINEERS at Northrop Aircraft, Inc., have developed an office-furniture-sized magnetic-drum digital differential analyzer for the solution

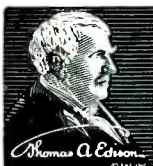

INSTRUMENT DIVISION  
**THOMAS A. EDISON, INCORPORATED**  
 WEST ORANGE, NEW JERSEY

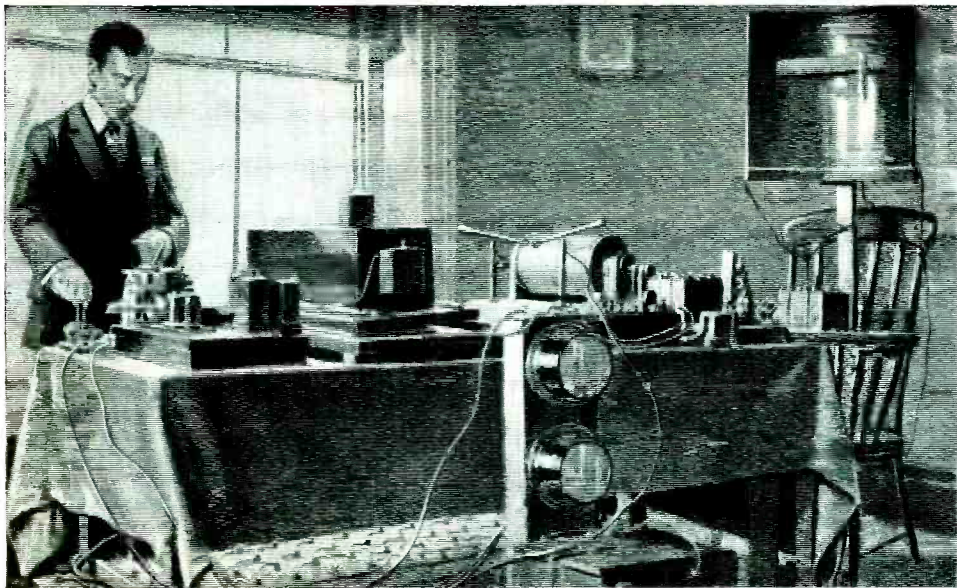

Above: Wireless telegraphy apparatus employed by Guglielmo Marconi in 1899. Right: 150-ft aerial mast at his Boulogne, France, experimental station.

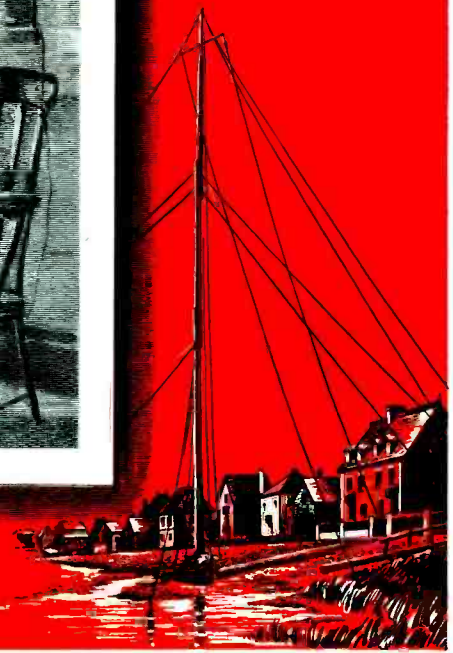

## Rendezvous With MASTERY

**1899**—and a young man, near Boulogne, France, presses the key of a transmitter. Instantly, his message clicks out on a receiver in Dover, England—32 miles distant. The way has been opened to mastery of instantaneous, world-wide communication.

**1899**—and a Board of Directors of an infant firm, convening for its initial meeting in Newark, N. J., hears the Treasurer state that \$1,400 is at the disposal of Driver-Harris Company with which to commence business. The way has been opened to mastery of new facts and techniques which will provide industry with quality metal products never before available.

“Wireless” has been developed with phenomenal speed since the day Marconi’s message was successfully transmitted from Boulogne. Within fifty years—as radio, television, and radar—it has been made to circle and serve the world.

And Driver-Harris, expanding within the same fifty years until represented on all five continents, has produced many of the alloys required. For example: Gridnic\* for electron tube grid wire, alloys for radio cathode sleeves and glass seal metals, Karma\* and D-H Manganin for resistors, and universally famous Nichrome\* and Nichrome V for resistors, plates and other components.

Today, Driver-Harris’ specialized knowledge and extensive facilities are employed in supplying superior alloys for a host of applications in numerous fields. The name “Driver-Harris”, indeed, has become so widely accepted as a synonym for quality that the demand for D-H products is engaging the resources of the firm to an unprecedented extent. Driver-Harris can only say it is utilizing all the mastery at its command to meet this exceptional demand as fully as possible.



Makers of Nichrome and over 80 other alloys for the electrical, electronic, and heat-treating fields.

### Driver-Harris Company

HARRISON, NEW JERSEY

BRANCHES: Chicago, Detroit, Cleveland, Los Angeles, San Francisco

In Canada: The B. GREENING WIRE COMPANY, LTD., Hamilton, Ontario, Canada

\*T.M. REG. U. S. PAT. OFF.



# RCA TUBES ...

*The complete line  
for industry ...*

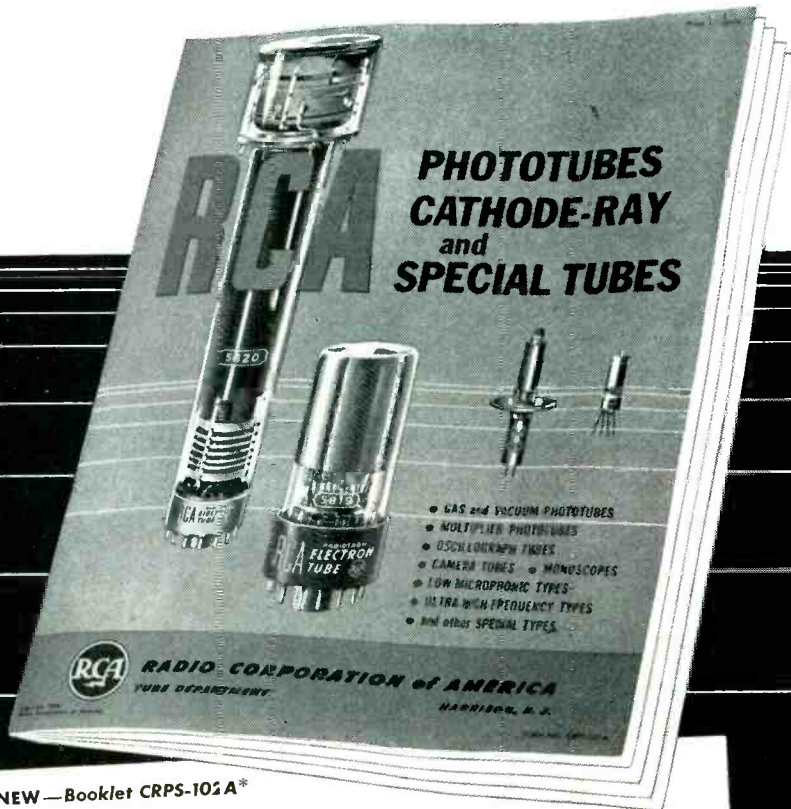

NEW — Booklet CRPS-102A\*

## Keep Posted on Electron Tubes ... through your RCA Tube Distributor

You can save time and money by keeping up-to-date on industrial electron tubes. Ask your local RCA Tube Distributor for the following literature ... or write RCA, Commercial Engineering, Section 42CT, Harrison, New Jersey.

**\*Phototubes, Cathode-Ray and Special Tubes** — Booklet CRPS-102A. Contains 20 pages of basic data on more than 150 tube types. Price, 15 cents.

**Power and Gas Tubes for Radio and Industry** — Booklet PG-101A. Contains 20 pages of basic data on more than 150 industrial tube types. Price, 15 cents.

**RCA Special Red Tubes** — Booklet SRB-1002. Complete data on industrial types 5691, 5692, and 5693. Free.

**RCA Interchangeability Directory** — Booklet ID-1020. Contains 20 pages of industrial tube replacement data. Lists 1600 tube type numbers used by 24 manufacturers. Price, 15 cents.



**RADIO CORPORATION OF AMERICA**  
**ELECTRON TUBES HARRISON, N. J.**

THE ELECTRON ART

(continued)



New techniques have enabled Northrop engineers to design this desk-side 400-pound computer. The computer can read 12 printed graphs or tables simultaneously, and plot six graphs or type out on 12 printers simultaneously as it operates

of problems in the aircraft and other industries. According to the designers, the computer combines large mathematical capacity, phenomenal accuracy, extreme ruggedness and reliability with amazingly small size and compactness—and low cost. The device will furnish solutions to ordinary differential equations or sets thereof, either linear or nonlinear, with accuracies in excess of any differential analyzers now existing.

Applications suggested for the computer, which is referred to as MADDIDA, include use as a general-purpose tool in engineering departments of large industrial firms for computation of design problems, such as stresses in large structures, vibration and windload calculations, heat transfer problems and so on. It lends itself particularly to analysis of new theories reducible to differential and integral equations.

MADDIDA is also capable of solving complex aerodynamic problems such as flight trajectories of missiles; aeroelastic problems of wing and body design; flutter and vibration problems; control problems; jet, rocket, or other propulsive device problems and again structural analyses. It can also be arranged to solve industrial control problems and to regulate or control chemical or physical processes and general research conditions such as heat or fluid flow.

In addition to being able to solve any ordinary differential equa-

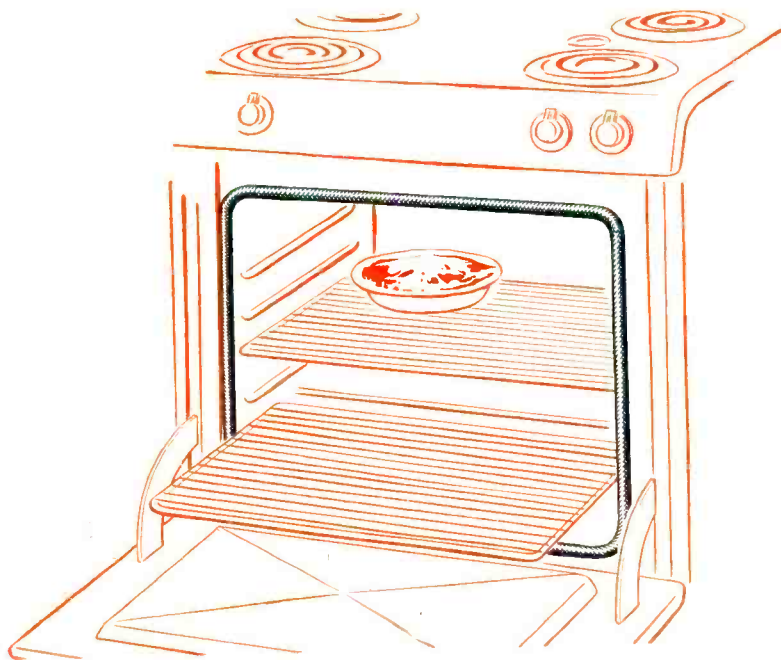

## The heat is "sealed in" when this door closes

See how the door of this electric oven closes on a strip of BH "750" Fiberglas Sleeving . . . closes and seals in the heat.

BH "750" is braided Fiberglas, tubular in shape,  $\frac{3}{8}$ " inside diameter, with these properties:

- (1) Oven heat won't impair it—no baking out or drying out even when subjected to prolonged high temperatures, nothing to melt or fuse.
- (2) Easy to work with—speeds assembly because of its remarkable flexibility. Non-fraying—without use of hardening varnish or lacquer.
- (3) Abrasion resistant—durability proved in service, no splitting or cracking under mechanical vibration.

BH "750" has merchandising possibilities, too. The oven door, illustrated, has the quiet closing of a Cadillac door—the tubular braid is "springy" in action, no porcelain-to-porcelain contact. Roasts do not dry out because moisture is sealed in the oven. Reduces staining of porcelain surfaces by minimizing leakage of heat or vapors from the oven.

BH "750" is a branch of the BH Insulation Family. There are many others. Whether you are interested in heat-resistant properties, dielectric properties, or a combination of both, BH Fiberglas Sleevings may be the answer to your problem. Write us today.

BENTLEY, HARRIS MFG. CO., CONSHOHOCKEN, PA.

# BH *Fiberglas*<sup>\*</sup> SLEEVINGS

\*BH Non-Fraying Fiberglas Sleevings are made by an exclusive Bentley, Harris process (U. S. Pat. No. 2393530). "Fiberglas" is Reg. TM of Owens-Corning Fiberglas Corp.

—USE COUPON NOW—

Bentley, Harris Mfg. Co., Dept. E-44, Conshohocken, Pa.

I am interested in BH "750" Fiberglas Sleeving. Send samples for production testing.

My heat sealing problem is \_\_\_\_\_

NAME \_\_\_\_\_ COMPANY \_\_\_\_\_

ADDRESS \_\_\_\_\_

Send sample and price on BH Electrical Insulating Sleevings:

- BH 649 Fiberglas Tubing, Grade A-1
- BH 649 Fiberglas Tubing, Grade B-1
- BH 649 Fiberglas Sleeving, Grade C-1
- BH Extra Flexible Fiberglas Sleeving
- BH Special Treated Fiberglas Sleeving



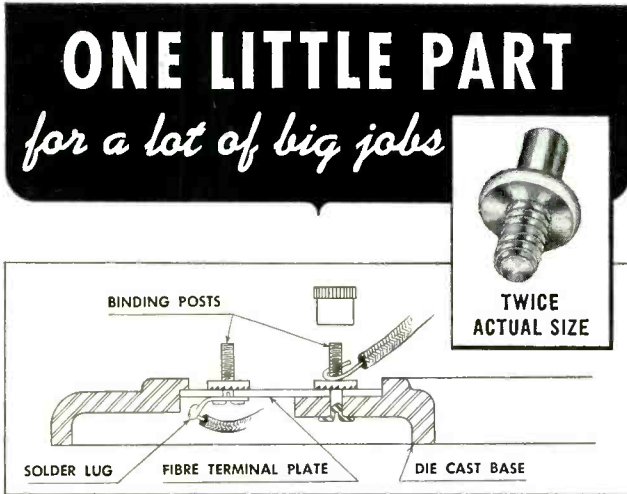

Lionel designed this non-turning, self-fastening binding post for making electrical connections to model railroad equipment, such as coal loaders. A multi-purpose fastener for a high quality product, it must be prefabricated with precision, speed and economy. Progressive provides the perfect facilities for specials such as this.

A combination tubular rivet and threaded post, the connector eliminates separate parts such as nuts and lock-washers, excludes expensive hand operations and permits multiple assembly. Made of headed stock, it curls without cracking. Serrations lock the post to keep it from turning. Tubular section holds the post to its base and may be used further to hold a soldering lug, etc. Drawing detail above shows the multiple functions performed by the fastener.

Special fasteners are our specialty. IF IT'S SPECIAL, see PROGRESSIVE.

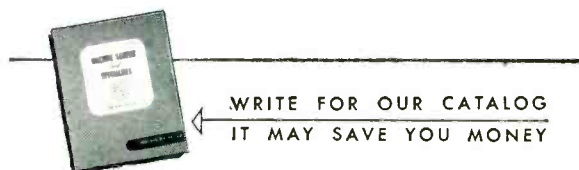

*Other typical* **PROGRESSIVE "Specials"**

**THE PROGRESSIVE MANUFACTURING COMPANY**  
 50 NORWOOD ST., TORRINGTON, CONN.  
 SALES OFFICES: SAN FRANCISCO, LOS ANGELES, PORTLAND, DETROIT, PHILADELPHIA, CLEVELAND, SEATTLE, BOSTON, SYRACUSE, ST. LOUIS, CHICAGO.

tion of any order or degree, linear or nonlinear, or any simultaneous set of such equations, it will also solve integral equations, transcendental algebraic equations and simultaneous sets of such equations. Some partial differential equations can be handled with special techniques.

Differential equations need not first be reduced to difference equations as has been necessary with previous computers of this type.

Information is transmitted between integrators in the form of incremental changes in variables.



Metal-drum memory device is capable of storing about 10,000 numbers which may be referred to by the computer during operation

Each integrator has a  $dx$  input through which it receives incremental changes in an independent variable  $x$ ; a  $dy$  input through which it receives changes in a dependent variable  $y$ ; and a  $dz$  output through which it delivers incremental changes in a new variable  $z$ , which bears the relation:

$$z = \int y dx$$

The source of  $dx$  may be the output of any one of 42 other integrators, or its own output, or any one of 12 empirical input channels. The source of  $dy$  may consist of the algebraic sum of from one to seven of the above sources in any combination. The  $dy$  input may also be omitted when using the integrator as a constant multiplier. In cases where the equation is such that  $dx$  must also consist of the sum of several channels, an additional in-



## The sleeper that took the 12 noon plane

Would you have been caught napping in a situation like this?

Suppose you were in the fashion business. You have just created a line of women's nightgowns that are going to give an unexpected publicity break in some top national magazines. This will mean more sales all over the country. But you must get more merchandise to the

stores in a hurry — or forever lose your golden chance to get sales.

What would *YOU* do?

This happened to one company recently — but the problem caused them to lose no sleep. Faced with this situation at 10:30 A.M. they were able to start goods flowing to the stores on planes that left at noon.

The answer was Air Express!

But you don't have to be in the fashion business to profit from the regular use of Air Express. Here are its unique advantages which any business can enjoy:

**IT'S FASTEST** — Air Express gives the fastest, most complete door-to-door pick up and delivery service in all cities and principal towns, *at no extra cost.*

**IT'S MORE CONVENIENT** — One call to Air Express Division of the Railway

Express Agency, arranges everything.

**IT'S DEPENDABLE** — Air Express provides one-carrier responsibility all the way and gets a *receipt upon delivery.*

**IT'S PROFITABLE** — Air Express expands profit-making opportunities in distribution and merchandising.

For more facts call Air Express division of Railway Express Agency.



**AIR EXPRESS**  
**GETS THERE FIRST**



## PUT OUT A STRONGER SIGNAL... INCREASE YOUR SERVICE AREA

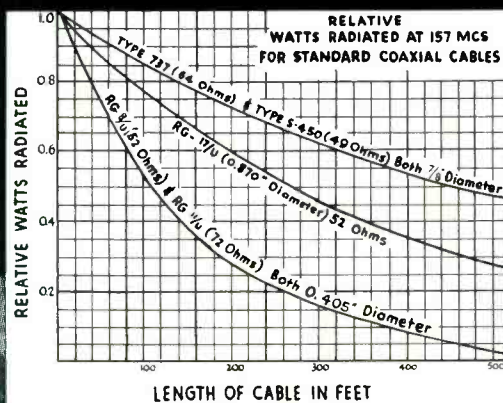

### with ANDREW Low Loss, High Economy Coaxial Cable

- 1/3 to 1/2 Less Loss than same diameter plastic type cables because 96% of insulation is air—the most effective insulation.
- No maintenance or operational costs. This advantage far offsets slightly greater original cost. Seamless cable and fittings remain completely gas tight and weatherproof indefinitely.
- Maintains original characteristics indefinitely. Lasts practically forever.
- TO INSTALL — JUST UNCOIL INTO PLACE. Each coil contains up to 2,000 feet of seamless semi-flexible tubing. No soldering. No splicing. Bends easily around corners or obstructions. Shipped under gas pressure at no extra cost when pressure-tight end fittings are ordered.



Low loss and economical operation will add extra miles to your service radius as well as give you a stronger signal in your present area. There's no waste. You get the greatest possible range and strength from your available power.

Whether you need transmission line for your Communications,

AM or FM transmitter, Directional Antenna System, or Rhombic Receiving Array, the solution to your problem is ANDREW low loss, high economy, semi-flexible transmission line. Write for further information on Types 737 and S-450 TODAY.



WORLD'S LARGEST ANTENNA EQUIPMENT SPECIALISTS

TRANSMISSION LINES FOR AM-FM-TV • ANTENNAS • DIRECTIONAL ANTENNA EQUIPMENT  
ANTENNA TUNING UNITS • TOWER LIGHTING EQUIPMENT

tegrator is used, coded as a simple adder.

Computation within the computer is done in the binary number system, since this leads to more compact and reliable circuitry. Initial conditions are typed into the computer as binary or octal numbers; however, output devices are available which will tabulate the results of MADDIDA computations directly in the decimal system.

The problem of scaling (positioning the decimal point) is much the same as that for an analog differential analyzer, and straight-forward systems have already been developed. Control of the scale is provided through the ability to arbitrarily designate the number of significant digits to be carried in any individual integrator. In most problems scaling can be conveniently handled in powers of two, making it unnecessary to use constant multipliers to change the scale.

In addition to the operations of integration and addition already mentioned, an integrator may be coded as a servo. This is useful in inverting operations and it is sometimes necessary to achieve proper scaling. Such a digital servo may be set up either as a proportional device with a predictable lag or it may be coded to operate as a tight, on-off servo where the servo error can be kept down to less than one part in a million.

Integrators may also be coded to exercise decision; for example, one might be set to stop all computation when a variable passes through zero or exceeds certain limits, or it



Problems are fed into the desk-side computer on a simple binary typewriter keyboard. The oscilloscope on top of the computer enables the operator to monitor and check his input figures

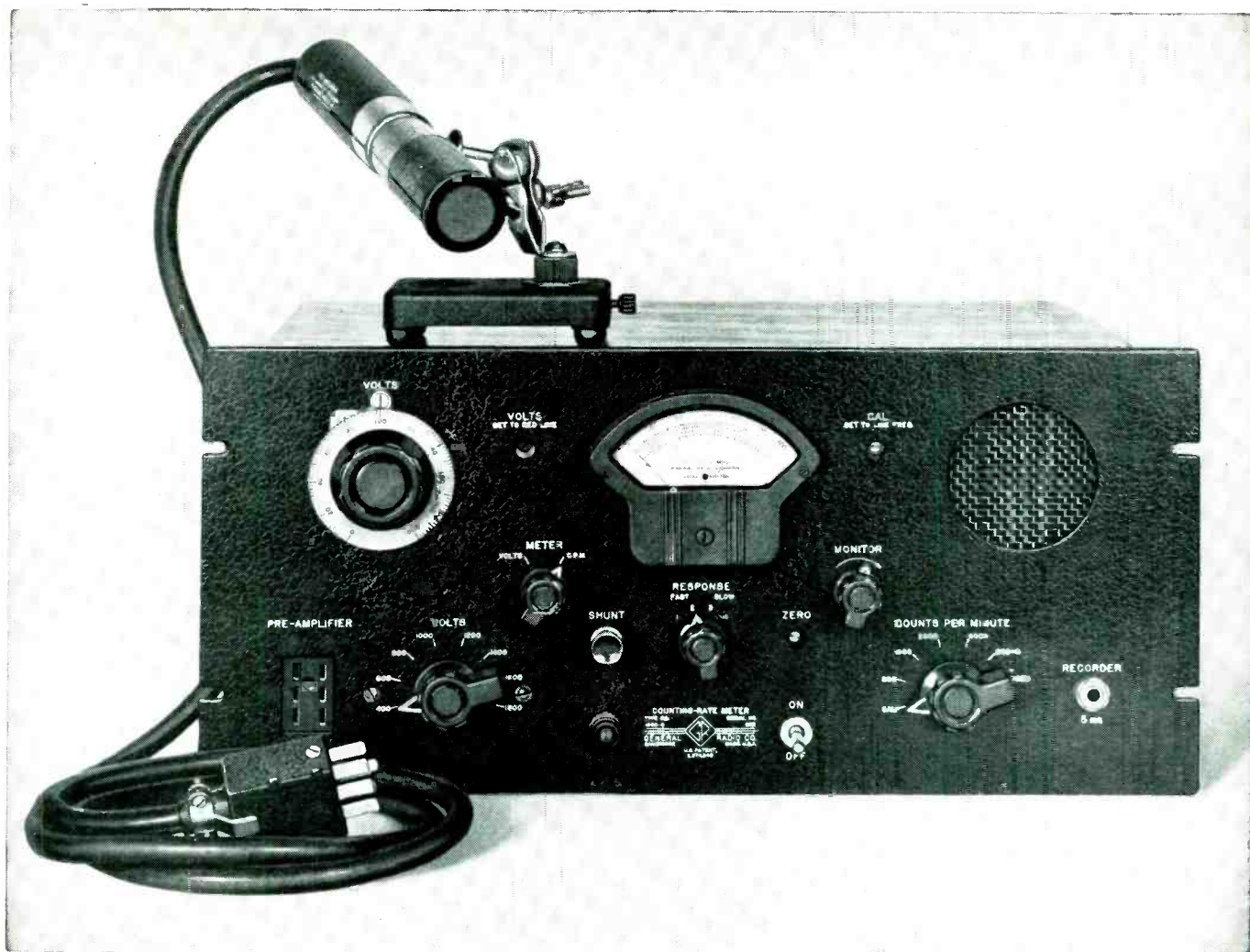

## IMPROVED COUNTING RATE METER FOR CONTINUOUSLY MONITORING RADIO-ACTIVE MATERIALS

- **RESPONSE CONTROL:** 4-position switch gives equilibrium time from 2 or 3 minutes to one second
- **NEWLY DESIGNED PRE-AMPLIFIER:** in small cylindrical anodized aluminum case; easy decontamination; long cable may be used; case equipped with tripod-type mounting thread (bench-top mount in photo is accessory sold separately)
- **NEW QUENCHING CIRCUIT** operates with self-quenching or non-self-quenching counter tubes
- **GREATLY INCREASED SENSITIVITY:** counting rate meter sensitivity increased four-fold; now responds to  $\frac{1}{4}$ -volt pulses
- **PANEL JACK TERMINALS** for 5 ma pen recorder providing continuous picture of what happens while radio-active material is being monitored; in absence of operator will show variations in the activity of materials being measured
- **AURAL MONITOR:** small, built-in loudspeaker, with volume control for aural monitoring
- **ADJUSTABLE VOLTAGE ON COUNTER CIRCUIT,** continuously variable from 400 to 2,000 volts (also available at terminals at rear of panel), with accurate voltage indication
- **VERY WIDE RANGE:** 5 to 20,000 counts per minute, full-scale values of 200, 600, 2000, 6000 and 20000; meter direct-reading in counts per minute on *all* scales
- **GOOD ACCURACY:**  $\pm 3\%$  of full scale on all ranges
- **COUNTER TUBES** not supplied with instrument; beta- and gamma-ray tubes available; tubes plug into probe cylinder

TYPE 1500-B COUNTING RATE METER . . . \$540.00



# GENERAL RADIO COMPANY

Cambridge 39,  
Massachusetts

90 West St., New York 6 920 S. Michigan Ave., Chicago 5 1000 N. Seward St., Los Angeles 38



# Highest Quality Tube Sockets

JOHNSON LINE OFFERS YOU MORE  
through Better Design,  
Finer Workmanship



In selecting a tube socket for any application, it is wise to insist on quality if long, efficient service is your goal.

Those who appreciate precise workmanship, superior design and quality components will readily appreciate why JOHNSON sockets are preferred by so many for such a wide variety of applications. Whether employing porcelain or steatite bases, there is none finer anywhere — at any price.

- 123-206 Industrial Bayonet, Steatite, Silver-plated beryllium copper contacts. Base is 4 pin super jumbo, 2 5/8" x 3 3/8".
- 123-209 Medium 4 pin bayonet, heavy phosphor bronze side wiping contacts. 2-13/16" Dia.
- 123-209SB Same as -209 but with Steatite base and beryllium copper contacts.
- 123-210 Similar to -209 except smaller diameter. 2 1/2" Dia.
- 123-211 Standard 50 watt type. Double filament contacts, phosphor bronze. 3 3/8" Dia.
- 123-211SB Same as -211 but with Steatite base and beryllium copper contacts.
- 123-216 Giant 5 pin Bayonet, phosphor bronze contacts. 3 3/4" Dia.
- 123-216SB Same as -216 but with Steatite base and beryllium copper contacts.
- 124-213 For Eimac 152TL and 304TL.
- 124-214 For Eimac, with air cooling jet.
- 124-215 For 250 watt tubes such as 204A, 849, etc.

CERAMIC MINIATURE SOCKETS		SHIELDS	
120-267	7 pin.	133-278A	1 3/8"
120-277B	7 pin with shield base	133-278B	1 3/4"
		133-278C	2 1/4"

**ACORN TYPE**

- 121-265 Steatite. Mounting centers: 1-3/16".

**SOCKETS FOR 833 AND 833A**

- 124-212 Steatite base. 5 1/8" plate leads.

**WAFER TYPES**

- Steatite, top and sides glazed. Brass contacts with steel springs, cadmium plated.
- 122-228 Octal socket. 122-225 5 pin.
  - 122-227 7 pin medium. 122-224 4 pin.
  - 122-226 6 pin. 122-217 7 pin small.
  - 122-237 Giant 7 pin Steatite wafer. For tubes such as HK257 and RCA813.
  - 122-247 7 pin Steatite for tubes such as 826.
  - 122-244 4 pin Steatite. Super jumbo base tubes such as 800B.
  - 122-101 7 pin Steatite wafer with shield. Designed for VHF use with tubes such as 832.
  - 122-275 Giant 5 pin Steatite wafer socket for 4-125A, RK48 tubes. Ventilation holes in base.

WRITE FOR COMPLETE CATALOG

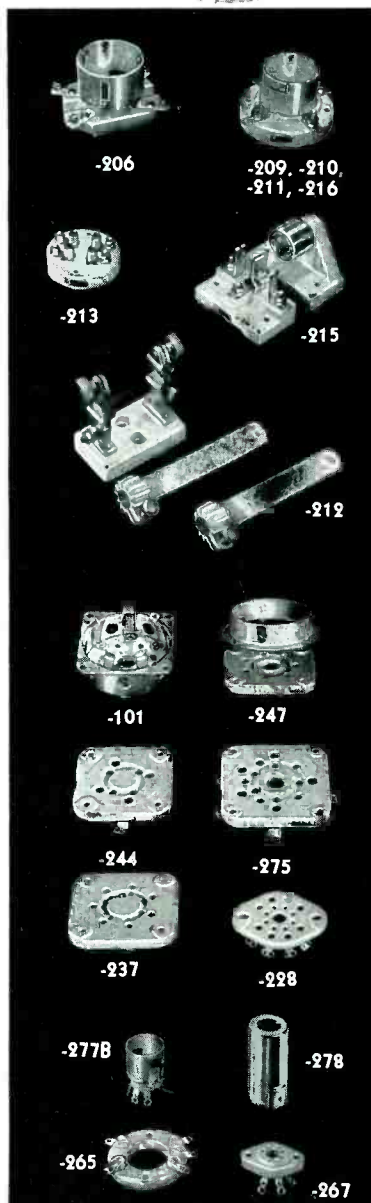

might be set to add or drop terms from an equation when one variable exceeds another.

The desired interconnections between integrators are easily expressed as a binary code, and this code is typed into the computer along with initial conditions. The actual interconnection of integrators is done fully automatically in the machine's electronic circuits.

While many functions can be generated within the computer by solving auxiliary differential equations, it is at times convenient to insert purely arbitrary or empirical data into the computation. For this reason 12 empirical input channels are provided in the machine. These input channels may be fed from various input devices. One such arrangement is now being made available as a graph follower with which graphical data is semi-automatically placed on perforated tape. A number of tapes may then be simultaneously fed into the computer through these input channels while computation proceeds. The independent variable (or speed of tape advance) is under control of the computer. Step functions may also be inserted at pre-set intervals with such apparatus.

Also provided in MADDIDA are 12 output channels. Read-out equipment operated from these channels, now available is: A tabulating printer which will accumulate and print results decimally, and an automatic plotter to present results graphically.

These input and output channels facilitate the use of MADDIDA as a control device. For example, the input channels might take information directly from instruments, and the output channels might directly operate switches, valves, or motors.

## Tuning Systems Employing Feedback Amplifiers

By PETER G. SULZER

National Bureau of Standards  
Washington, D. C.

It is possible to alter the effective value of an inductance or a capacitance by means of a feedback amplifier. The method is applicable

**JOHNSON** a famous name in Radio  
**E. F. JOHNSON CO. WASECA, MINNESOTA**

*Mitchell-Rand*

**M**

**THE ONE  
DEPENDABLE  
SOURCE OF SUPPLY  
FOR EVERYTHING IN  
ELECTRICAL  
INSULATION**

**R**

**MIRAGLAS\***  
WOVEN TAPES, TUBINGS  
SLEEVINGS, CORDS  
CLOTHS, ETC.

**VARNISHED TUBINGS,  
SLEEVINGS & TAPES**

**COTTON TAPES & SLEEVINGS  
FIBERGLAS-MICA COMBINATIONS  
VARNISHES · WAXES  
COMPOUNDS**

**\* WOVEN OF FIBERGLAS YARN**

M-R THE  
ELECTRICAL  
INSULATION  
HEADQUARTERS  
FOR 61 YEARS.



**MITCHELL-RAND INSULATION CO. Inc.**

51 MURRAY STREET · Cortlandt 7-9264 · NEW YORK 7, N. Y.

A PARTIAL LIST OF M-R PRODUCTS: FIBERGLAS VARNISHED TUBING, TAPE AND CLOTH · INSULATING PAPERS AND TWINES · CABLE FILLING AND POTHEAD COMPOUNDS · FRICTION TAPE AND SPLICE · TRANSFORMER COMPOUNDS · FIBERGLAS SATURATED SLEEVING · ASBESTOS SLEEVING AND TAPE · VARNISHED CAMBRIC CLOTH AND TAPE · MICA PLATE, TAPE, PAPER, CLOTH, TUBING · FIBERGLAS BRAIDED SLEEVING · COTTON TAPES, WEBBINGS AND SLEEVINGS · IMPREGNATED VARNISH TUBING · INSULATED VARNISHES OF ALL TYPES · EXTRUDED PLASTIC TUBING



*Precision  
Engineering  
Your  
Guarantee*



9 out of 10  
TV FUSES are...



6717 N. BAYVIEW AVE., CHICAGO 48, ILL.

where large variations are required, and is particularly useful where an L-C resonant circuit is to be tuned over a wide frequency range.

Consider an amplifier of voltage gain  $A$  having an infinite input impedance and a zero output impedance. An impedance  $Z$  is connected between its input and output terminals. With  $Z_e$  defined as shown in Fig. 1, it is found that

$$Z_e = \frac{Z}{1 - A}$$

Four conditions can be considered.

$$\begin{aligned} -\infty < A < 0 & \quad Z_e/Z < 1 \\ 0 < A < 1 & \quad Z_e/Z > 1 \\ A = 1 & \quad Z_e/Z = \infty \\ 1 < A < \infty & \quad Z_e/Z < -\infty \end{aligned}$$

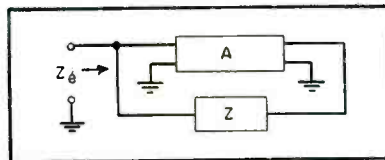

Fig. 1—Feedback amplifier connected for impedance multiplication or division

If  $L_e$  and  $C_e$  are the equivalent values of  $L$  and  $C$  when either one is inserted for  $Z$ ,

$$L_e = \frac{L}{1 - A} \text{ and } C_e = (1 - A) C$$

With the first condition,  $L$  is effectively decreased, while  $C$  is increased (Miller effect<sup>1</sup>). With the second,  $L$  is effectively increased, while  $C$  is decreased. The third condition is trivial in this application, while the fourth may produce instability, and will not be considered here.

It is worth noting that the variations in the equivalent values of the components can be obtained without a serious loss of  $Q$  or selectivity. This requires only that the output impedance of the amplifier be kept low, and that its input impedance be high.

The required variation of amplifier gain can be obtained by employing an attenuator or potentiometer or, if desired, by electronic means. Thus it has been possible to tune an L-C circuit over a 30-to-1 frequency range by means of a potentiometer;

## The New STAVER MINI-SHIELD

TRADE MARK REG. AND PAT. PEND.



**The shield  
that fits all  
Miniature  
Tubes**

A flexible shield that snugly fits all miniature tubes because it compensates for all variations in tube dimensions. Mini-Shields are made for both T5½ and T6½ bulb tubes. Send for catalog sheet.

**THE Staver COMPANY**  
INCORPORATED

91 PEARL ST. • BROOKLYN 1, N. Y.  
ULSTER 5-6303

WHEN YOU THINK OF  
**VERY  
LOW  
FREQUENCY**  
THINK OF

**SIE**

- **OSCILLATORS**  
1/100 CPS — 120,000 CPS
- **TRANSFORMERS**  
Miniature Hermetically Sealed
- **AMPLIFIERS**
- **DC AMPLIFIERS**
- **CARRIER AMPLIFIERS**
- **AC-DC VOLTMETERS**
- **RESISTANCE METERS**  
Write for Descriptive Bulletins

**SOUTHWESTERN INDUSTRIAL  
ELECTRONICS COMPANY**  
2831 Post Oak Road Houston, Texas

*instrument*  
**DIALS**

**SPECIAL CHECK LISTS**

- LUMINESCENT
- BLACK & WHITE
- MADE TO YOUR SPECIFICATIONS

**PRECISION  
INSTRUMENT  
SERVICE**

WE REPAIR, OVERHAUL  
AND STANDARDIZE LABORATORY  
AND PORTABLE INSTRUMENTS

Our laboratory is equipped with new  
Leeds & Northrup potentiometric stand-  
ardization equipment calibrated in  
terms of the Absolute units which  
were adopted internationally as  
of January 1, 1948.

*Standard Products*  
650 EAST GILBERT • WICHITA, KANSAS

# ELECTRONIC ENGINEERS

## Development and Design

---

*RCA Victor offers attractive opportunities for:*

ELECTRICAL ENGINEERS

PHYSICISTS

MECHANICAL ENGINEERS

Engineers with several years' experience will find their future in the wide scope of RCA's activities in the following fields:

- TELEVISION DEVELOPMENT
- TRANSFORMER AND COIL DESIGN
- COMMUNICATIONS—Aviation and Mobile
- ANTENNAS AND SERVO-MECHANISMS
- VIDEO AND COMPUTER CIRCUITRY
- MICROWAVE AND RADAR
- NAVIGATIONAL AIDS

These requirements represent permanent expansion in the RCA Victor Engineering Division at Camden, N. J. RCA offers starting salaries commensurate with experience and ability; periodic review for salary increases based on individual merit; comprehensive Company-paid hospitalization, accident and life insurance; a liberal retirement program; paid vacation and holidays; opportunities for graduate study. If you are looking for a career which permits the complete expression of your talents in the field of electronics,

Write, enclosing resume, to:

National Recruiting Division, Box O-36, RCA Victor Division,  
Radio Corporation of America, Camden, New Jersey





you can depend upon  
**PYROFERRIC**  
 Your best bet for  
**POWDERED IRON CORES**

**PYROFERRIC** engineers are specialists and pioneers in the technique of powder metallurgy development and iron core manufacture. Consult with them on your iron core or powder metallurgy requirements...no requirement either too small or too large.



**OUR SPECIAL DEFENSE CONTRACT DEPARTMENT ASSURES PROMPT SERVICE FOR ALL GOVERNMENT WAR WORK.**

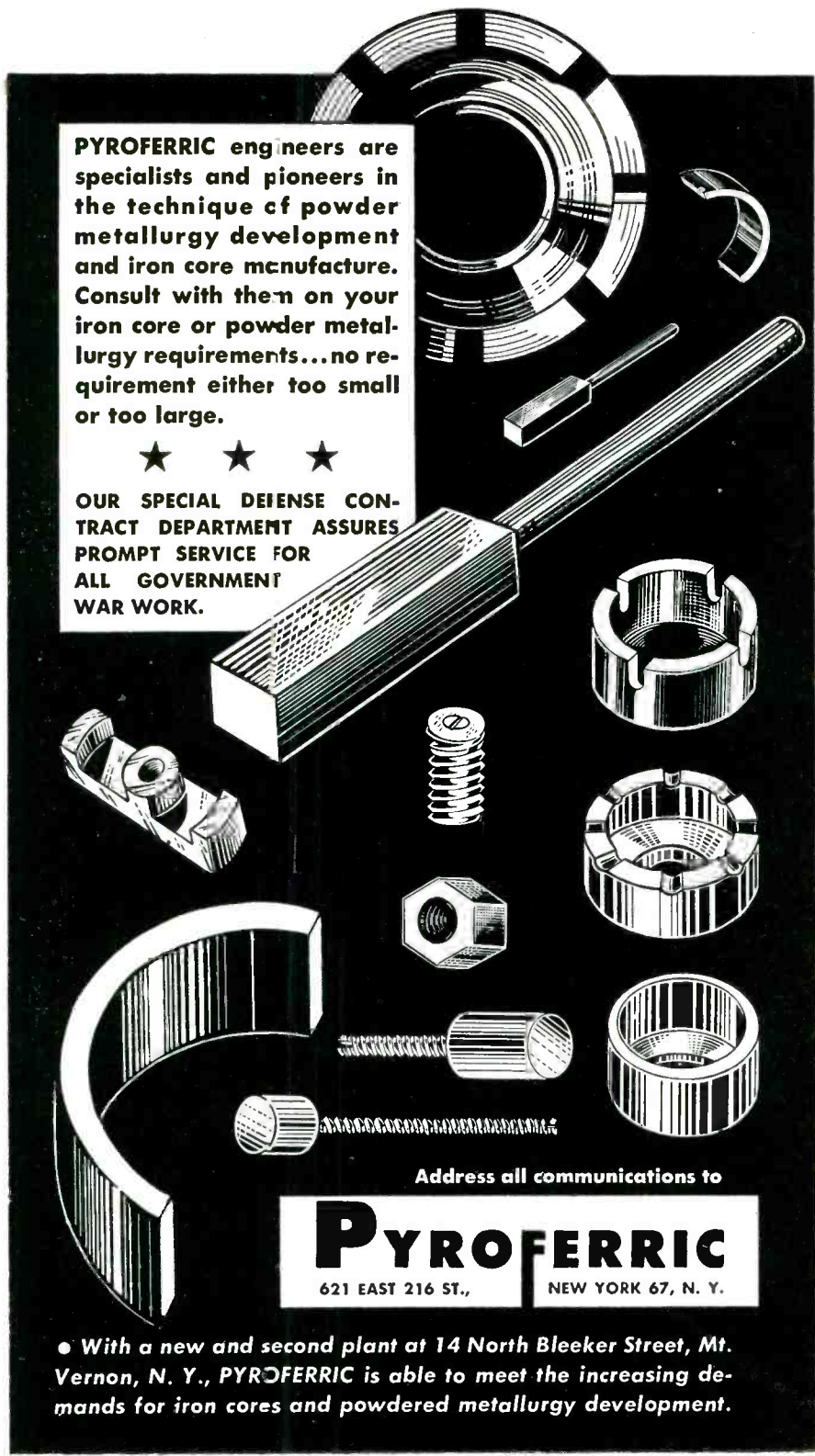

Address all communications to

**PYROFERRIC**  
 621 EAST 216 ST., NEW YORK 67, N. Y.

• With a new and second plant at 14 North Bleeker Street, Mt. Vernon, N. Y., PYROFERRIC is able to meet the increasing demands for iron cores and powdered metallurgy development.

the same frequency ratio was obtained by changing the grid bias of one of the amplifier tubes. Since a potentiometer is a more stable circuit element than a variable- $\mu$  tube, better frequency stability will be obtained when using potentiometer tuning. However, electronic tuning is to be preferred when

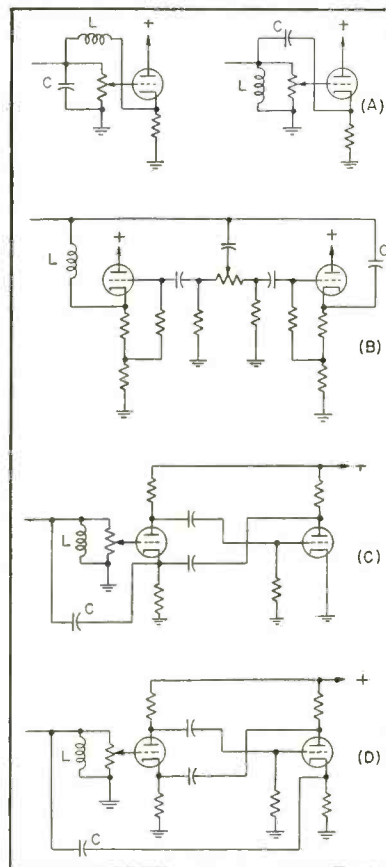

Fig. 2—Simple cathode-follower tuners, A; dual cathode-follower tuner, B; two-stage tuners providing large frequency ratios with good stability C and D

rapid or remote frequency variation is required.

*Practical Circuits*

Many circuits can be devised using the scheme presented here. Figure 2 contains a few that have been investigated by the writer.

The simple cathode-follower circuits of Fig. 2A produced a frequency ratio of 5 when using a parallel-connected 12AT7. The equivalent resistance inserted in series with the tuned circuit is approximately 100 ohms, which re-

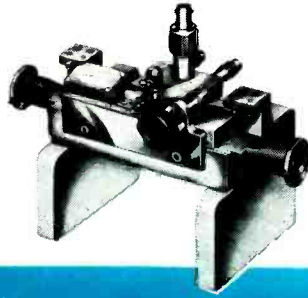

# Precision Test Equipment

by **PRD**

**ATTENUATORS and TERMINATIONS  
IMPEDANCE MEASUREMENT  
and TRANSFORMATION  
TRANSMISSION LINE COMPONENTS  
FREQUENCY MEASURING DEVICES  
DETECTION and POWER MEASUREMENT  
SIGNAL SOURCES and RECEIVERS**

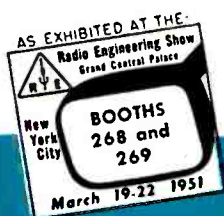
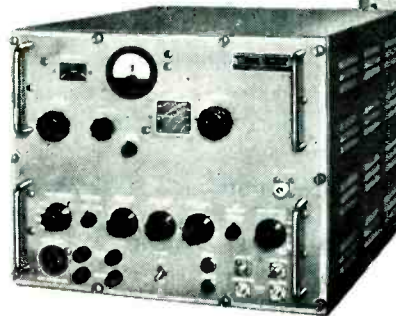
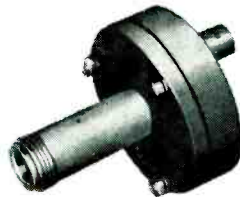
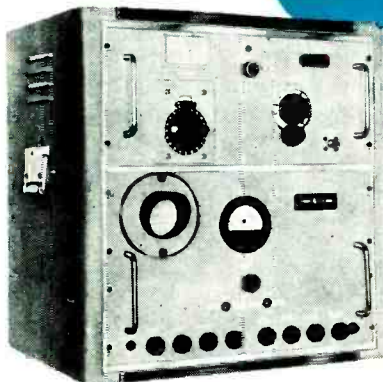
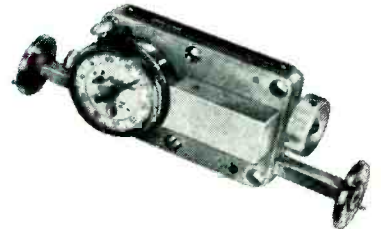
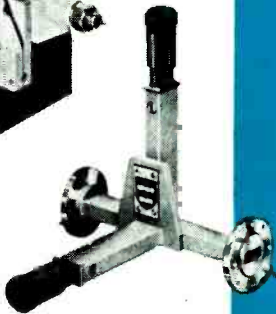

*Polytechnic* **RESEARCH & DEVELOPMENT COMPANY, Inc.**

202 TILLARY STREET, BROOKLYN 1, NEW YORK





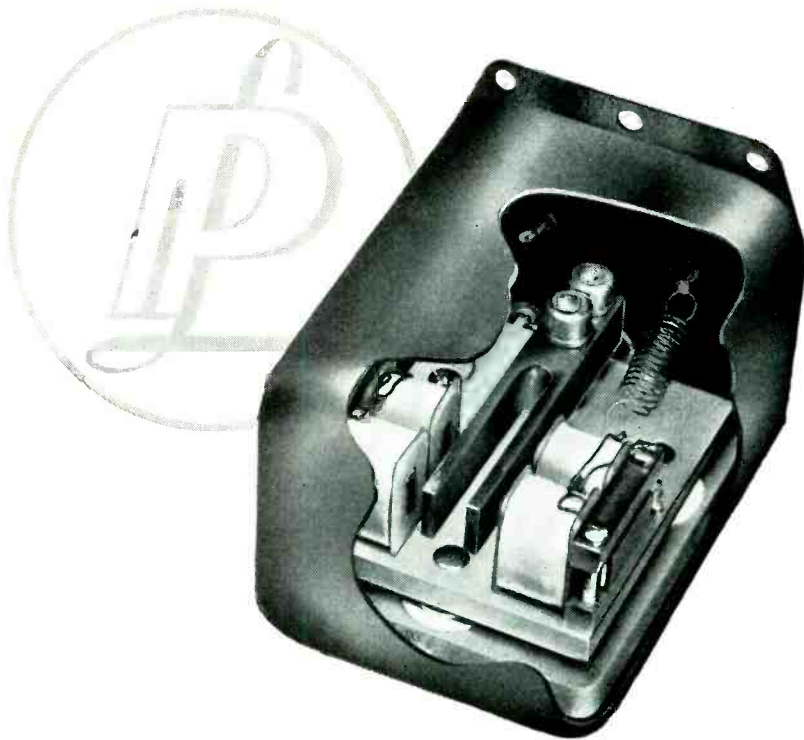

# Tuning Forks

## for precision frequency control

A complete line of tuning fork resonators to meet your reference standard . . . timing . . . or speed control requirements.

**ACCURATE** . . . Manufactured in accuracies up to 1 part in 10,000 for operation from  $-40$  to  $+75^{\circ}\text{C}$ .—and up to 1 part in 100,000 for operation from 0 to  $+75^{\circ}\text{C}$ .

**COMPENSATED** . . . Thermal compensation method employed maintains fork accuracy throughout rated operating temperature range without benefit of oven control or warm-up time.

**RUGGED** . . . Internally shock-mounted using relatively permanent, semi-inorganic, silicone rubber—a desirable feature for stringent shock and vibration applications.

**HERMETICALLY SEALED** . . . Solder-sealed evacuated container prevents barometric pressure and relative humidity variations from affecting fork accuracy.

**FREQUENCIES** . . . 400 cycles and from 700 to 3,000 cycles for accuracies up to 1 part in 10,000—from 1,000 to 3,000 cycles for accuracies up to 1 part in 100,000.

Available individually—as a part of compact sub-assemblies—or in completely engineered equipment constructed to your specifications.

Write Dept. B for complete information or telephone HYacinth 2-4800.

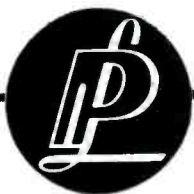

**PHILAMON LABORATORIES**  
5717 Third Avenue Brooklyn 20, N. Y.

quires that a high L/C ratio be employed to avoid excessive degradation of Q. The dual cathode follower of Fig. 2B provided a frequency ratio of 25. The equivalent resistance is 400 ohms, which may be undesirable in some applications, particularly at radio frequencies.

### Cathode Follower

These three circuits do not employ a large feedback factor to stabilize A; hence relatively poor frequency stability will be obtained when large frequency ratios are used.

The completely degenerative amplifier\* of Fig. 2C is superior in this respect. In addition, the output impedance may be less than 1 ohm, while the voltage gain may be as high as 0.999, resulting in a frequency ratio of approximately 30. When using a pentode-triode amplifier to tune an oscillator with a frequency ratio of 10, the frequency was constant within 1 percent for plate-supply-voltage variations of  $\pm 50$  percent.

The circuit of Fig. 2D differs from the previous ones in that A is negative. A frequency ratio of 10 was obtained using a pentode driving a triode. Larger ratios can be obtained by employing more stages, but instability becomes a serious problem.

### Conclusions

The simple cathode-follower circuits are most useful for obtaining wide-deviation frequency modulation at radio frequencies. They should also be useful for tuning radio receivers, although tube noise will be contributed by the amplifier. The two-stage circuits, which are limited to audio or video-frequency applications because of the coupling networks used between stages, have been employed in wide-range, resistance-tuned audio oscillators.

### REFERENCES

- (1) J. M. Miller, "Dependence of the Input Impedance of a Three-Electrode Vacuum Tube upon the Load in the Plate Circuit," Bureau of Standards Scientific Paper 351.
- (2) Calvin T. Hammack, "Cathode Follower," Report 469, Radiation Lab., MIT, Cambridge, Mass.; also see *ELECTRONICS*, p 206, Nov. 1946.

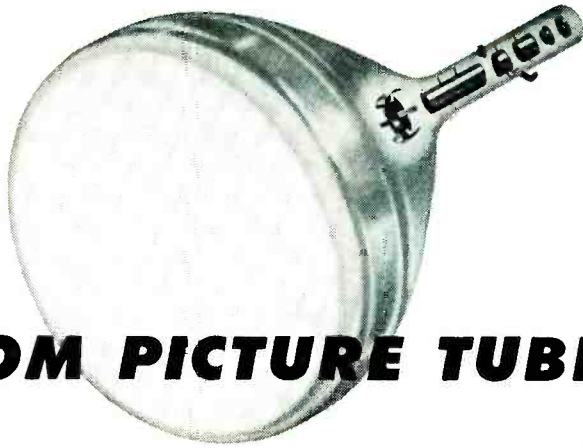

**FROM PICTURE TUBE**

**...TO CATHODE RAY**



**AND SUBMINIATURES**

## **What we have done for industry**

In 1950 Volkert produced over 260,000,000 precision stampings and became the leading independent supplier of metal parts for electron guns.

## **...we will do for defense**

Volkert has wide experience in designing and building high-production dies and producing parts for cathode ray tubes and radar. Volkert is again ready to help American industry turn out the parts for electronic equipment which is vital to the Armed Forces.



Volkert can help you in your defense production. Write today for our brochure, "3-Way Facilities for Precision Stampings." It shows how Volkert successfully combines—under one roof—integrated facilities for design engineering, tooling and production...to produce millions of small, intricate stampings yearly.

JOHN VOLKERT METAL STAMPINGS, INC.  
222-34 96th Avenue, Queens Village 8, L. I., N. Y.

# **Volkert**

PRECISION STAMPINGS





# PRESTO . . . most carefully made recording disc in the world

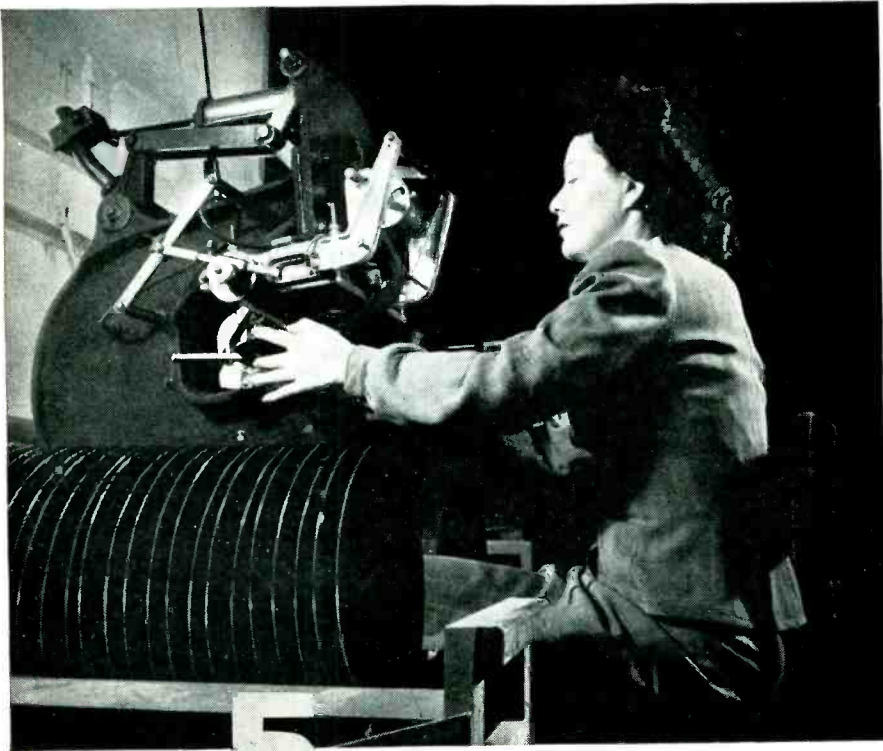

## step 3 - grading and labeling

Although every recording disc that leaves the modern PRESTO plant is made with meticulous care and the finest materials, only those that have passed the most rigid inspection can qualify for the "Green Label." This label on a disc means that it possesses as perfect a recording surface as can be created by modern methods.

After discs have been carefully graded, they are assigned various color label distinctions. Drive holes are punched and they are sent to the labeling press, where brilliant colored labels are stamped into the lacquer surface. "Green" means the finest, "Brown" is applied to those discs with slight imperfections, while the "Orange" label denotes a disc of lighter gauge and smaller diameter.

Labeling is another of the quality-controlled processes in PRESTO disc manufacture . . . another reason why the PRESTO label is always a reliable guide in your selection of a recording disc.



The famous PRESTO "Green Label"  
. . . world's finest recording disc.

Visit PRESTO's booth at the IRE SHOW  
March 19th to 22nd • New York City

# PRESTO

RECORDING CORPORATION

Paramus, New Jersey

Mailing Address:

Box 500, Hackensack, New Jersey

Overseas:

M. Simons & Son Co., Inc.

25 Warren Street

New York, New York

In Canada:

Walter P. Downs, Ltd.

Dominion Sq. Bldg.

Montreal, Canada

## NEW PRODUCTS

(continued from page 146)

supply and bridge control unit designed for use with transducers employing resistance elements. A scope jack and chopper are provided in order to observe steady as well as vibratory phenomena on c-r oscilloscopes without preamplification. The unit contains a d-c power source of 100 v at 100 ma with an a-c ripple of less than 1 mv. A 10-turn helipot permits precise bridge balancing.

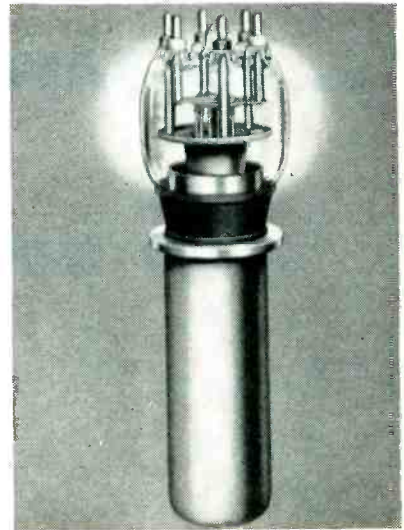

### High-Powered Triode

FEDERAL TELEPHONE AND RADIO CORP., 100 Kingsland Road, Clifton, N. J., has developed the F-5918 200-kw triode to meet the increasing demand for higher power in the broadcast and shortwave bands. The three-electrode tube is suitable for use as a radio-frequency amplifier, oscillator, or class B modulator. The heavy-wall, high conductivity copper anode is water-cooled and is capable of dissipating 60 kw in continuous commercial service. It weighs approximately 25 pounds. Maximum ratings to 22 mc can be achieved.



### Selenium Rectifier Cartridges

INTERNATIONAL RECTIFIER CORP.,  
6809 So. Victoria Ave., Los Angeles

March, 1951 — ELECTRONICS

**General  
Electric  
can build  
and test**  
**JAN-C-25  
CAPACITORS**  
**in mass  
production  
quantities**

*Apparatus Department,  
General Electric Company,  
Schenectady 5, New York*

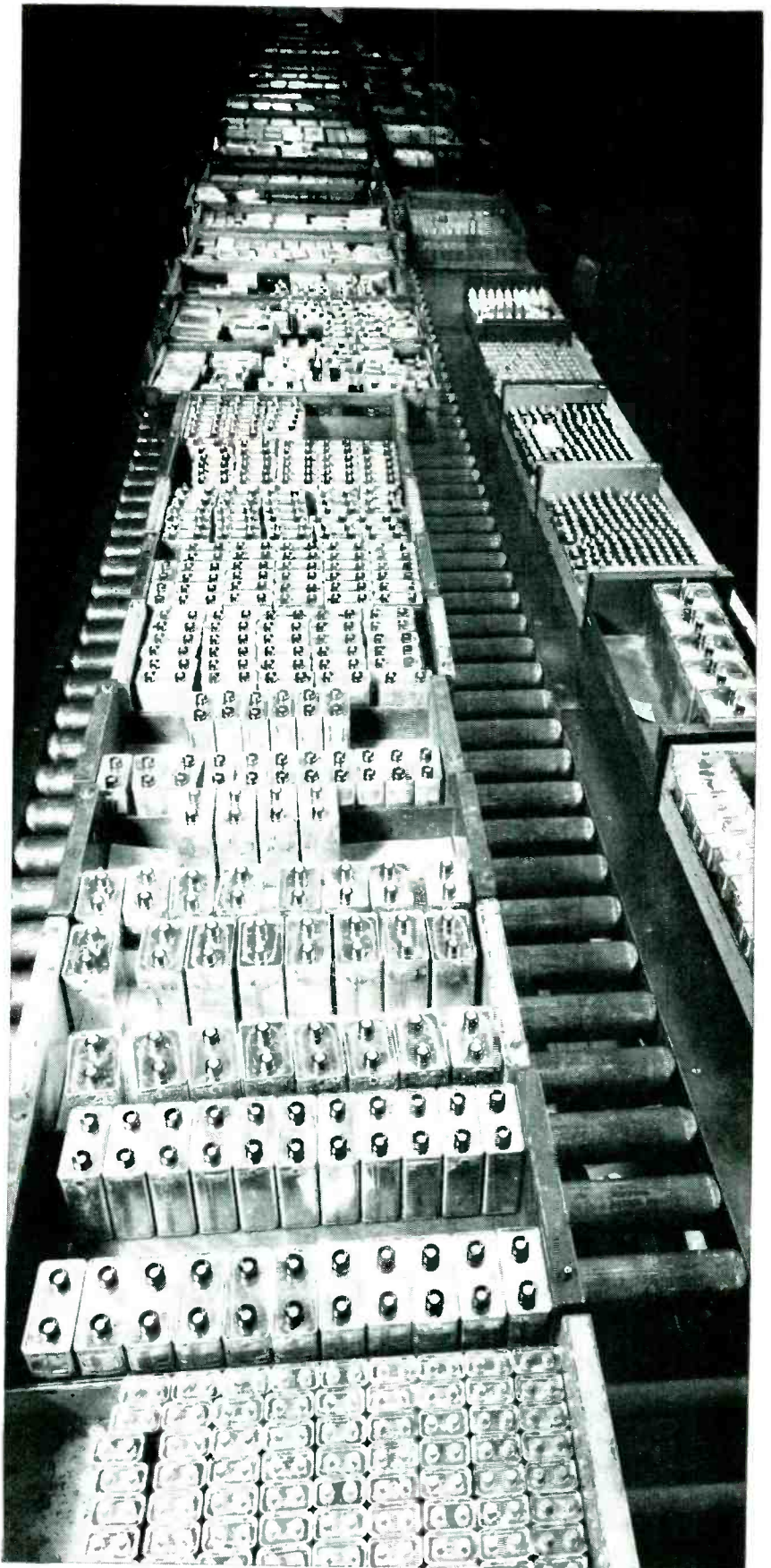

**GENERAL**  **ELECTRIC**

407-361



# VIBRATION *Control* CAN BE YOUR PROBLEM...

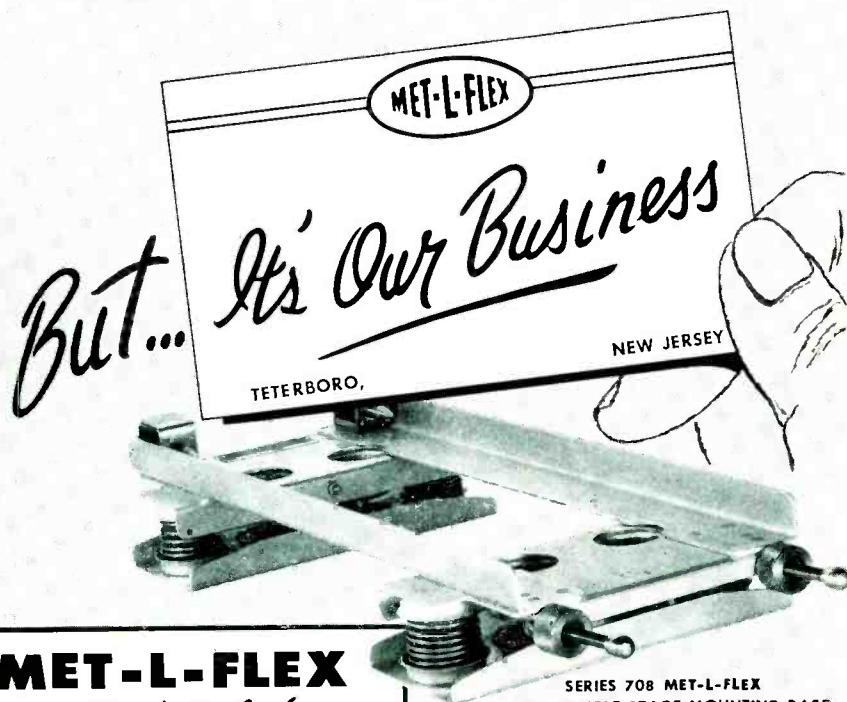

## MET-L-FLEX

Made Only by  
**ROBINSON**

*The First*

*All-Metal • All-Weather*  
**SHOCK MOUNTING  
SYSTEMS**

First with MET-L-FLEX, Robinson pioneered, in 1946, all-metal, all-weather vibration and shock mounting systems. Built for the electronic and instrument panel installations of today's high performance commercial and military aircraft, more than 50,000 all-metal systems have been delivered. Robinson MET-L-FLEX unit mounts and complete mounting systems meet specifications JAN-C-172A and AN-E-19. Mounting systems in JAN form factors and special designs are available—write today for full engineering data.

Look for us at the I.R.E. Show—  
Booth S-4

SERIES 708 MET-L-FLEX  
SINGLE STAGE MOUNTING BASE

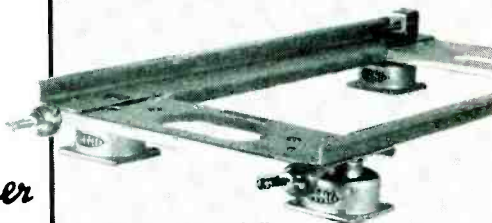

SERIES 831 MET-L-FLEX  
UNIT SUSPENSION MOUNTING BASE



SERIES 7002 MET-L-FLEX  
UNIT MOUNT



SERIES 6952 MET-L-FLEX  
UNIT MOUNT

**ROBINSON AVIATION INC.**  
TETERBORO, NEW JERSEY  
*Vibration Control Engineers*

NEW PRODUCTS

(continued)

43, Calif., has developed a line of h-v selenium rectifier cartridges with voltage ratings up to 25,000 v per cartridge and current ratings up to 75 ma. They utilize five different selenium cell sizes varying from  $\frac{1}{4}$  in. in diameter up to 1 in. in diameter, with corresponding current ratings varying from 1.5 ma up to 75 ma; and can be operated over the temperature range of  $-55^{\circ}\text{C}$  to  $100^{\circ}\text{C}$ . Type W248HS (illustrated) is rated at 4,960 v d-c output at 75 ma, and its over-all length is 13 in. with an outside diameter of  $1\frac{1}{4}$  in.



## Audio Mixer

THE PENTRON CORP., 221 E. Cullerton St., Chicago 16, Ill. Audio-Mix, an electronic mixer for all audio systems, has four individual controls that permit a wide range of audio blending applications on each of its four channels simultaneously. It features six high-impedance inputs, four microphone and two phonograph. Microphone gain is 8 db; phonograph gain,  $-22$  db. Frequency response is 20 to 20,000 cycles; power consumption, 8 watts. List price is \$59.50.



## Vacuum Gage

HASTINGS INSTRUMENT CO., INC., Super Highway at Pine Ave., Hampton 10, Va., has announced a new direct-reading vacuum gage

*One* OF A LINE...

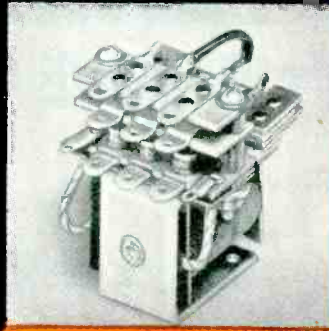

Series 335 D.C. Relay



*The*  
**GUARDIAN**  
Series 335 D.C.  
**RELAY**



The A.N. CONNECTOR TYPE mounting is approved by the Army and Navy as standard hermetic seal termination equipment. This type of mounting is particularly adaptable where shielded or cabled circuits are a necessity. Vibration-proof mounting with quick connect and disconnect is insured.

Approved—distinguished by spectacular performance in truck train communications and thousands of flying echelons—The Guardian Series 335 D.C. Relay! Hermetically sealed or with conventional open and special mountings, unit offers a wide variety of applications. Series 335 D.C., built to rigorous aviation standards, meets the 10-G Vibration Test and the Mil-R-6106. Generous coil winding area permits single windings up to 15,000 ohms. Parallel and double windings available.

Maximum voltage: 220 V.D.C. Power requirement: Normal, 3½ watts. Max.-resistance standard unit: 12,000 ohms. Applicable to time delay attract up to .06 second and release up to .01 second. Contact rating: ¼" dia. silver, 12 amps. at 24 V.D.C. inductive load. Combinations up to 3 P.D.T. with 12 amp. contacts. Bakelite insulated, tested at 1500 V.—60 C.

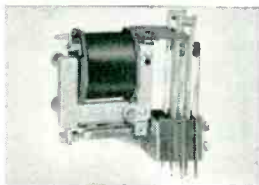

Series 30 A.C.

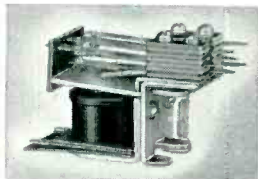

Series 210 A.C.—215 D.C.

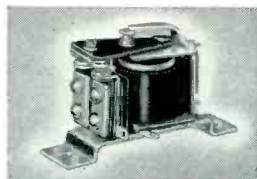

Series 220 A.C.



Series 595 D.C.

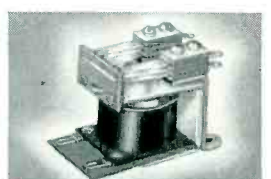

Series 610 A.C.—615 D.C.

WRITE OR WIRE... FREE CATALOG, SPECIFIC RECOMMENDATIONS, NO OBLIGATION.

**GUARDIAN**  **ELECTRIC**  
1625-C W. WALNUT STREET CHICAGO 12, ILLINOIS

A COMPLETE LINE OF RELAYS SERVING AMERICAN INDUSTRY



# "NOFLAME-COR"

the TELEVISION hookup wire

fits perfectly  
into this  
picture

Meets government  
specification  
AN-J-C-49a

- FLAME RESISTANT
- HEAT RESISTANT
- HIGH INSULATION RESISTANCE
- EASY STRIPPING
- HIGH DIELECTRIC
- FACILITATES POSITIVE SOLDERING

Also  
is not affected by the  
heat of impregnation . . .  
making it an ideal wire  
for use in connection  
with coil and trans-  
former leads

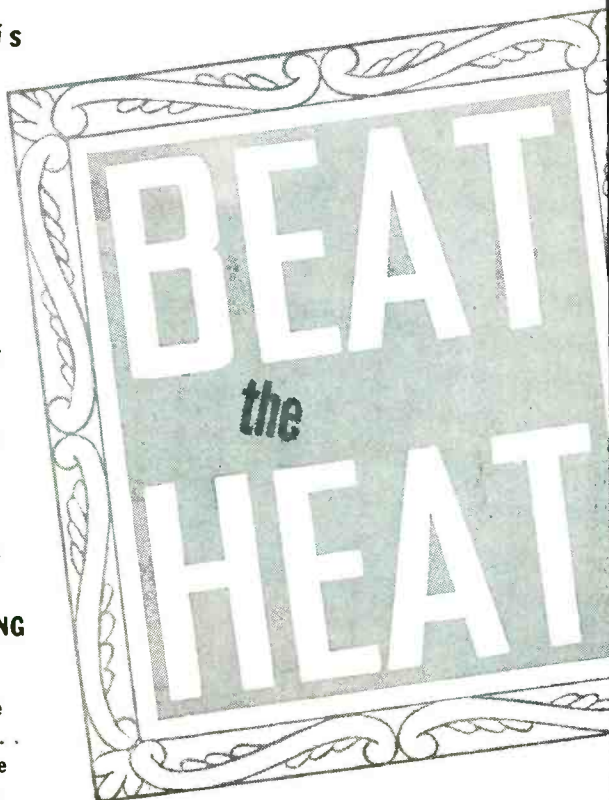

No "Nicking" problem in using this proven wire. Not being an extruded plastic, its diameter uniformity can be absolutely guaranteed. This eliminates nicking of conductors and constant re-setting of blades in the cutting process. Available in all sizes, solid and stranded, in over 200 color combinations . . . "NOFLAME-COR" assures maximum output and minimum rejects.



"made by  
engineers  
for engineers"

No "blobbing" of insulations under soldering heat, because "NOFLAME-COR" is NOT an extruded plastic. Production executives specify it as the most efficient heat-resistant wire yet developed. Save time, money and assembling headaches. Investigate!

**CORNISH WIRE COMPANY, Inc.**  
50 Church Street, New York 7, N. Y.

**Branch Offices**

- PHILADELPHIA
- BRIDGEPORT
- CLEVELAND
- CINCINNATI
- CHICAGO
- DETROIT
- MINNEAPOLIS
- ST. LOUIS
- ATLANTA
- DALLAS
- DENVER
- LOS ANGELES
- SAN FRANCISCO
- SEATTLE

MANUFACTURERS OF QUALITY WIRES AND CABLES FOR THE ELECTRICAL AND ELECTRONIC INDUSTRIES

with a five-position switching attachment. It gives rapid response (less than 1/2 sec) for laboratory or production instrumentation, and its unique design includes such features as noble metal thermopiles and nickel-plated pickup tubes. The nickel-plated pickup tubes afford freedom from outgassing, system contamination and corrosion. The unit can measure absolute pressures of from 0 to 1,000 microns of mercury. Its rugged gage tube connects to the vacuum system by means of a standard 1/8-in. male pipe thread. Length of the cable from the indicator to the pickup tube does not affect calibration so extensions for remote indications may be added if desired.



## Proportioning Input Controllers

AUTOMATIC TEMPERATURE CONTROL Co., Inc., 5200 Pulaski Ave., Philadelphia 44, Pa. Series 4700 Atcronic input controllers answer the demands of the industrial electric furnace users for accurate, automatic control of temperatures. Based on the rate of charge and discharge of a capacitor, this proven circuit enables the user to line-out without incurring undue overshoot. The ability to operate with a very narrow proportional band (2 percent in many cases) eliminates set point shift with varied load changes. Type 4702-A incorporates a snap-acting precision switch, independently wired. It is load-rated 10 amperes at 115 v, 5 amperes at 230 v a-c, noninductive, 25, 50 or 60 cycles. Type 4702-B uses a mercury switch relay. It is load-rated 30 amperes at 115 v,

they

may

look

alike,

but:

there

is

only

one

**C-D**

# A C-D FILTER FOR EVERY APPLICATION!



In a wide range of sizes and container shapes to meet every known interference filtering application. A few typical types are listed below. Thousands of other types on request. Our engineers will be glad to consult with you on your specific noise problems. Engineering bulletin on request. CORNELL-DUBILIER ELECTRIC CORPORATION, Dept. K31, South Plainfield, New Jersey. Other plants in New Bedford, Brookline and Worcester, Mass.; Providence, R. I.; Indianapolis, Ind., and subsidiary, the Radiart Corp., Cleveland, Ohio.

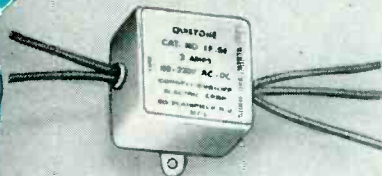

**Capacitive inductive filters** — single and multiple section pi circuits in hermetically sealed containers for aircraft, marine, and heavy-duty application requiring filters with high insertion loss over temperature range from  $-55$  to  $+85^{\circ}\text{C}$ .



**Feed-through capacitive TV and radio noise filters** — Compact! Lightweight! Numerous insertion-loss patterns available. Hermetically sealed! Dykanol impregnation!



**Electrical appliance filters** — for fluorescent lamps, food mixers, vacuum cleaners, business machines, and a wide variety of other electrical equipment available in many styles with both flexible lead and solder lug electrical connections.

FOR EFFECTIVE NOISE ELIMINATION . . . FOR DEPENDABLE RESULTS  
. . . FOR PREMIUM QUALITY PERFORMANCE . . . ALWAYS SPECIFY C-D!



1910-1951

CONSISTENTLY DEPENDABLE

## CORNELL-DUBILIER

CAPACITORS • VIBRATORS • ANTENNAS • CONVERTERS



SUBSIDIARY



# small OPEN GEAR TRAINS made to your specifications

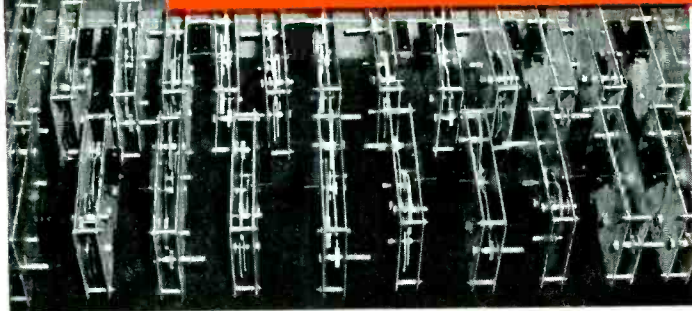

Many units, such as timers, transmitters, vending mechanisms, and similar devices require the adoption of small open gear trains for intermittent duty. Beaver Gear Works is equipped to make these trains to any degree of accuracy required. Beaver Gear engineers, knowing what is expected, and qualified to assist in details of fine-pitch gear applications, can advise you as to what will work best under various conditions and can specify the correct design.

MEMBER OF



## Beaver Gear Works Inc.

1021 PARMELE STREET, ROCKFORD, ILLINOIS

Consult us on your gear problems.

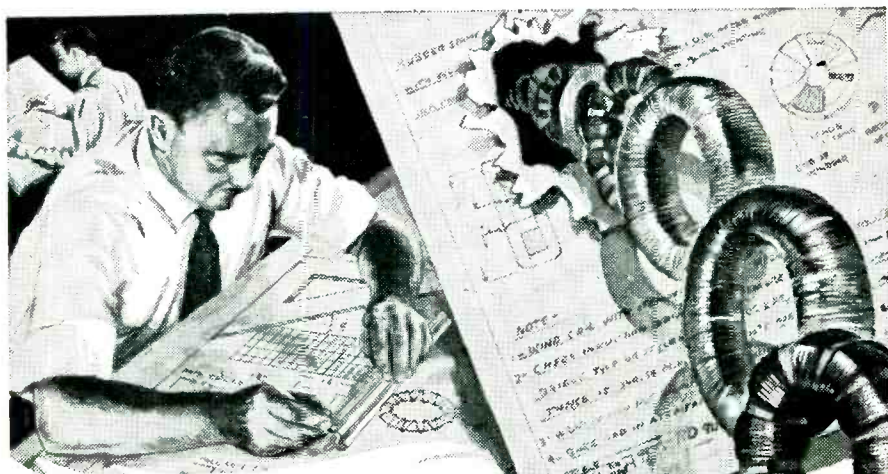

## High-quality, Low-cost TOROIDAL COILS

Universal-developed coil-winding machines produce a better toroidal coil, custom-built to your blueprint specifications, at considerably lower unit cost! Wound on any type cores (any I.D. to 3"), in any size wire, Universal toroidal coils are perfectly uniform and fully insulated. Send your blueprint specifications today, and let us quote the lower cost of better Universal toroidal coils on your next order.

Address:



Toroidal Coil Division

**Universal Manufacturing Company, Inc.**  
404 Hillside Avenue • Hillside, N. J.

NEW PRODUCTS

(continued)

20 amperes at 230 v, a-c noninductive, 25, 50 or 60 cycles.

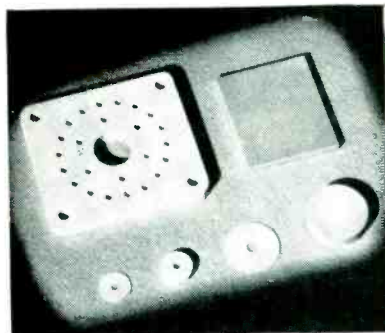

## Technical Ceramics

AMERICAN LAVA CORP., Chattanooga 5, Tenn., has available a line of optically flat discs and plates of Al Si Mag technical ceramics that are custom made in any size up to 9 in. in diameter. They are very hard, totally and permanently rigid, resistant to heat shock and can be used at elevated temperatures. The material is resistant to all alkalis and acids except hydrofluoric acid. Dimensional accuracy can be maintained within almost any limits specified. The three larger pieces shown above are flat within one to two light bands (0.0000116 in. to 0.0000232 in.). Test samples can be produced to specifications.



## Vibration Control Mountings

LORD MFG. CO., Erie, Pa. The Temproof (temperature-proof) vibration control mounting is designed specifically to meet the requirements of base-mounted airborne electronic equipment and functions efficiently throughout the entire range of operational temper-

# How to make Oscillograms **FAST!**

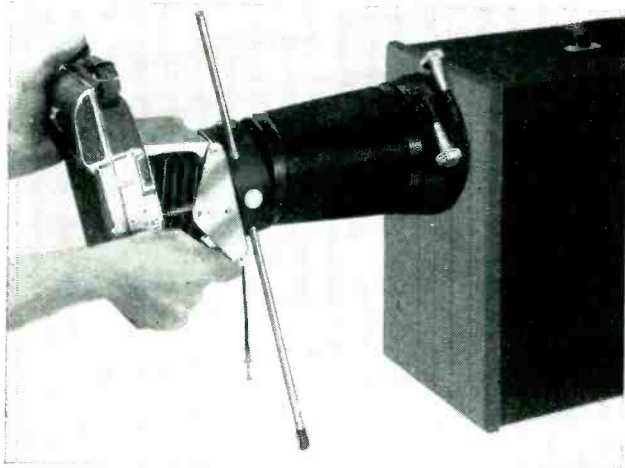

**Set up the camera.** The Fairchild-Polaroid camera consists of three units: adapter ring, hood, and camera body. To set it up, you place the handy adapter ring over the oscilloscope bezel, slip the hood into the ring, then snap the camera into the bayonet lock on the hood. That supporting rod is a safety feature that protects both camera and oscilloscope.

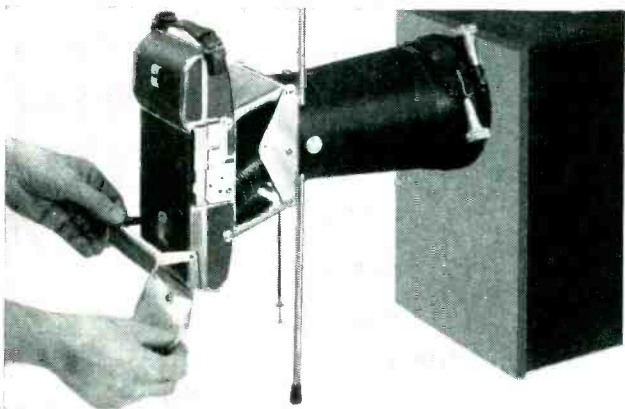

**Pull the tab to finish exposed print.** After a snap of the shutter, the exposure is made and you're ready to finish the print. If you want two exposures, it's easy to move the camera body down and make a second exposure. To finish the print, you merely pull tab at back of camera.

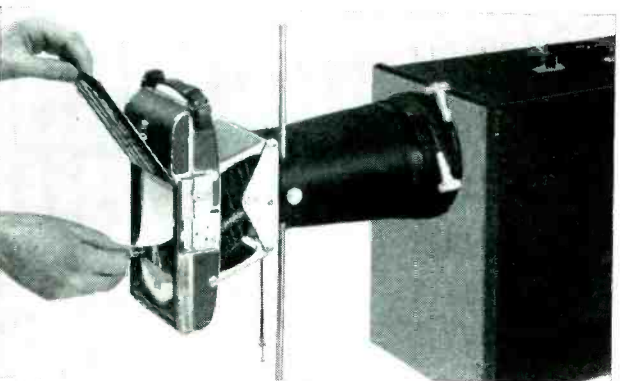

**Remove the finished print.** A minute after you've pulled the tab, the finished print is ready for evaluation. Just open the camera back and there it is. An easy job, but you have a photographically accurate record of the trace in less time than you could sketch it from memory.

- SET UP THE CAMERA
- SNAP THE SHUTTER
- SEE THE PRINT

**ALL IN 3 MINUTES**—or even less  
with the Fairchild-Polaroid® Oscilloscope Camera

The easiest way is the fastest way when you're photographing oscilloscope images with the Fairchild-Polaroid® Oscilloscope Camera.

No more darkroom processing! With this new camera it takes only two minutes (less if you're fast) to set up and snap the picture, one minute to finish a print. Each 3¼ x 4¼ print records traces exactly one-half life size to make comparisons easy.

Write for complete data and prices on F-284 Oscilloscope Camera Kit including camera, carrying case, and film. Fairchild Camera and Instrument Corporation. 88-06 Van Wyck Boulevard, Jamaica 1, N. Y. Dept. 120-14A.

## SPECIFICATIONS

**LENS**—Special 75 mm. f/2.8 Wollensak Oscillo-anastigmat.

**IMAGE SIZE**—One-half reduction of scope image.

**SHUTTER**—Wollensak Alphax; speeds 1/25 sec. to 1/100 sec., "time," and "bulb."

**WRITING SPEED**—to 1 in./μsec at only 3000V accelerating potential; higher speeds at higher voltages.

**FOCUS**—Fixed (approx. 8 in.)

**DIMENSIONS**—Camera, 10½ x 5¼ x 6¼ in.; hood, 11 in. length, 7½ in. dia.; adapter, 2 in. width, 6⅝ in. max. dia.

**PICTURE SIZE**—3¼ x 4¼ in. (2 or more images per print; 16 exposures per roll of film.)

**WEIGHT**—Complete, 7¾ lb.

*Typical of the work being done with this camera is this 3¼ x 4¼ print of 35-millisecond single-sweep transient—one of a series of accelerometer-output recordings that made possible the completion of nine recorded "drop-tests" in 40 minutes.*

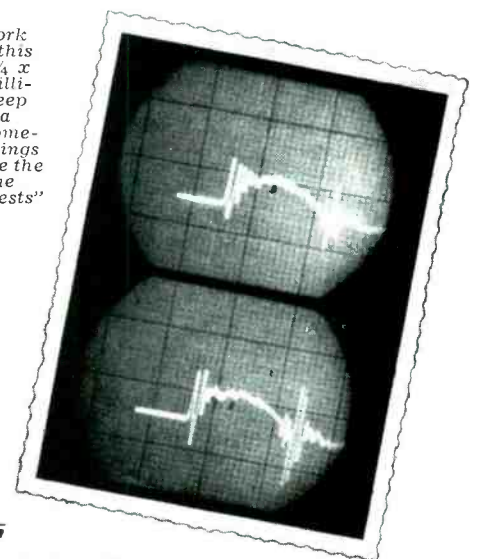

**FAIRCHILD**  
OSCILLOSCOPE RECORDING CAMERAS

See the Fairchild-Polaroid Oscilloscope Camera and the Fairchild Oscillo-Record Camera at the Radio Engineering Show, Booth 238-239.



Here's why those in the know

-demand

# CANNON PLUGS

Ribbed for excellent grip.

Boss prevents movement.

With special anodized or lacquered finishes, threads are masked to maintain shielding or bonding.

Interchangeable pin and socket inserts... fit all Cannon shells of same diameter.

No section of plug exceeds end bell diameter.

Contacts, precision-machined from solid bar stock, electroplated with silver or gold.

90° end bell can be set at 60° interval.

Type AN Connectors are made in 6 styles; straight and 90° cord plugs; box, wall, and extension cord receptacles; and special quick disconnect plugs. Fifteen diameters for inserts with contact arrangements from single to 100 contacts. Contact capacities from 5 to 200 amps. Peak voltages from 70 to 9,000 volts.



*Cannon split-shell design advantages*

no assembly tools needed  
end bells are interchangeable  
no slack in lines  
test without disengaging plug  
easy inspection and circuit changes

See that your circuit requirements are met. See that all control, communication and power circuits have firm positive contact, low dielectric loss...and see that each circuit is protected by the design advantages found only in Cannon Plugs. AN Connector Series is just one of the many Cannon types—world's most complete line. Request bulletins by required type or describe the connector service you need.

## CANNON ELECTRIC

Since 1915

LOS ANGELES 31, CALIFORNIA

REPRESENTATIVES IN PRINCIPAL CITIES

NEW PRODUCTS

(continued)

atures from -80 F to +250 F. It is designed for use with Government Specification JAN-C-172A equipment. Friction dampers are designed in to prevent excessive equipment motion at resonant frequencies. Although intended primarily for use with airborne electronic equipment the new mounting will fill an additional need in the industrial field for applications in areas subject to temperatures above and below the range in which rubber mountings are ordinarily used.

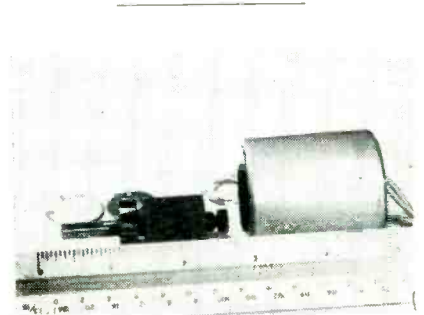

### Miniature Induction Motor

EASTERN AIR DEVICES, INC., 585 Dean St., Brooklyn 17, N. Y. Type J49D-16 miniature induction motor was primarily developed for use by manufacturers of aviation and portable military equipment. It operates from a 3-phase, 200-volt, 400-cycle source and is rated as follows: 1/50th h-p, 0.25 ampere, 10,000 rpm. This reversible motor is totally enclosed, weighs 10 ounces, is 1 1/4 in. in diameter and 1 1/8 in. long.



### Preamplifier-Equalizer

BROCINER ELECTRONICS LABORATORY 1546 Second Ave., New York 28, N. Y. Model A100P preamplifier-equalizer is a flexible, compact, high-quality equalized preamplifier for use with constant velocity (magnetic or dynamic) pickups

If you use the **880**  
 you will get  
**BETTER PERFORMANCE**  
**LOWER OPERATING COSTS**  
 and **LONGER LIFE . . .**

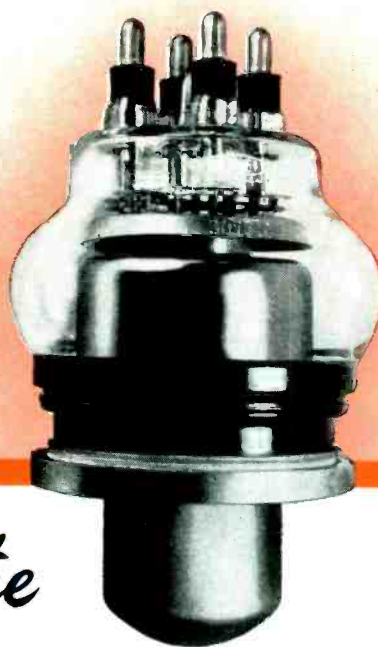

*... with the*

## **ML-5658**

**T**HE ML-5658 is an improved and directly interchangeable version of the widely used 880. Designed originally as a better, more rugged tube for electronic heating equipment, it has since found extensive use in the high power broadcast field and in such exacting applications as cyclotron and synchrotron oscillators.

The ML-5658 incorporates in its design many of the outstanding features developed by Machlett Laboratories for all its industrial tubes. Typical of these design and process improvements which have given broadcast and industry better, more dependable tubes are:

1. **Kovar-to-glass seals.** The elimination of the inherently weak feather-edged copper seal—increasing seal strength and providing greater stability of the internal electrode structure.
2. **An improved, stress-free, self-supporting filament structure** which substantially eliminates filament distortion, provides uniform filament emission throughout tube life and reduces the complexity and the hazards of the older spring-supported filament construction.

3. **A unique pre-exhaust treatment of all parts and the thorough, high voltage exhaust of each tube on Machlett's special high voltage, high temperature exhaust system.\***

These, and many other improvements in tube design and processing, provide for every installation which uses or contemplates the use of an 880 type tube, a far more rugged longer lived tube in the ML-5658. It will directly replace the 880 with *no* electrical or mechanical changes and will provide better performance, longer tube life and more economical operation.

The ML-5658, like other Machlett industrial tubes, is available with the Machlett automatic seal water jacket.† This new jacket eliminates the use of tools and the hazard of tube breakage and water leakage. The jacket cannot be opened unless the water pressure is off, nor closed unless the tube is properly installed.

Complete technical data on both tube types is available upon request. Write direct to Machlett Laboratories, Inc., Springdale, Connecticut.

\* Patent No. 2,324,559. † Patent applied for.



Export Distributor



**Machlett Industrial and Broadcast Tubes**  
**will be exhibited at the 1951 I.R.E. Show**  
**Booth 96-97**

OVER 50 YEARS OF ELECTRON TUBE EXPERIENCE





having outputs as low as 10 mv. It affords exact compensation for widely varying recording characteristics. It has a 39-db voltage gain and a 20,000-ohm output impedance. The device uses a 12AY7 low-hum nonmicrophonic dual triode for initial stages; and a 6C4 for output stage. Price is \$83.33 F.O.B. factory.

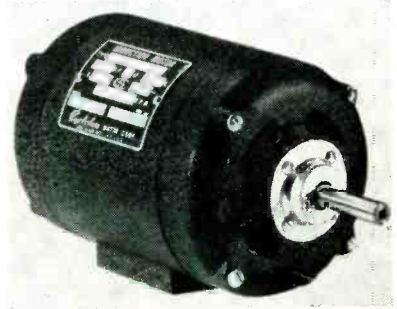

### Induction Motor

HOWARD INDUSTRIES, INC., Racine, Wis., Model 2900 fractional h-p motor is a two-speed hysteresis motor for use in tape-recording applications. It is also available as non-synchronous capacitor motor and torque motor with high resistance rotor. The unit is rated 1/100 to 1/15 h-p. Among its uses are the powering of blowers for electronic equipment, in telegraph switching equipment and in tape pullers for automatic code equipment.

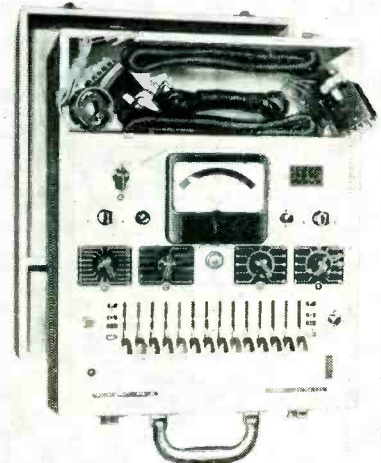

### C-R Tube Tester

PRECISION APPARATUS Co., INC., 92-27 Horace Harding Blvd., Elmhurst, L. I., N. Y., announces the

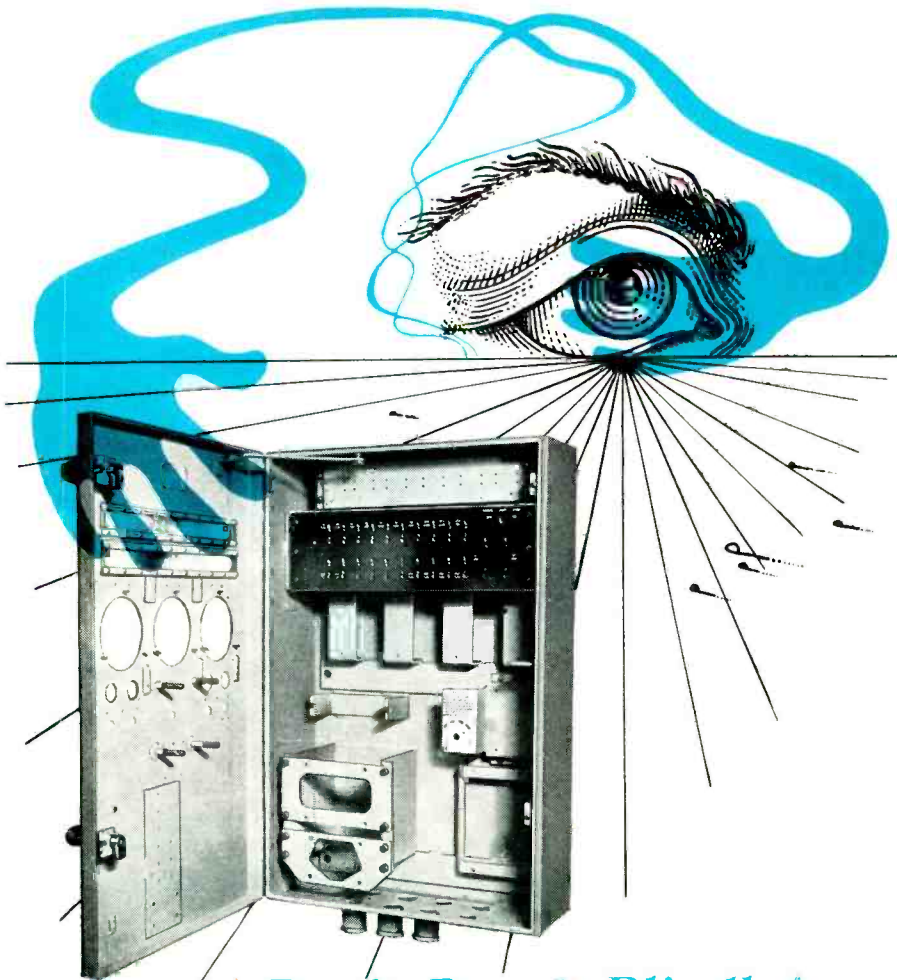

## Don't Reach Blindly!

When converting for defense purposes, don't reach blindly for your sheet metal work supplier. There's no substitute for *know-how*. We're Armed Forces Certified (men and machines) in steel, aluminum, other non-ferrous metals.

Donnelly regularly produces close tolerance parts and enclosures for the top military manufacturers of radar, sonar, bombsight, fire control and jet engine equipment and is *fully geared* to the Nation's mobilization program.

We're ready *today* to discuss your sheet metal requirements. Why take a chance? Take Donnelly!

## Donnelly MANUFACTURING

A DIVISION OF JOHN DONNELLY & SONS  
3134 WASHINGTON ST., BOSTON, MASS.

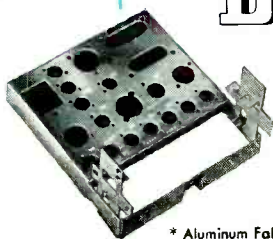

\* Aluminum Fabrication



PRECISION SHEET METAL & PRESSED WOOD FABRICATION

# Wherever **SELENIUM RECTIFIERS** can be used... be sure to specify



*Federal*

## —to meet requirements of military end-use equipment

**Requirements** for military end-use equipment are rigid and exacting. To meet them fully and efficiently you need the quality that is backed by America's *oldest* and *largest* manufacturer of Selenium Rectifiers...the "know-how" that has pioneered every major advancement in their design and construction since they were first produced in the U.S. by Federal, in 1938.

Federal's unmatched experience in building Selenium Rectifiers to meet an almost unlimited range of specifications is more valuable now than it was in World War II, when tremendous quantities were produced to power equipment used by the nation's fighting forces.

This same experience is yours for the asking... ready to assist you in determining or developing the Selenium Rectifier that will do the job demanded by government specifications.

## 2 Important Examples of Engineering to Meet Government Specifications

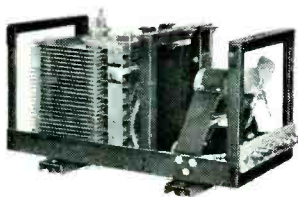

**FTR 3146-BS  
AIRCRAFT  
POWER SUPPLY**

**FTR 3141-CS-03  
CLIP-IN  
VOLTAGE REGULATOR**

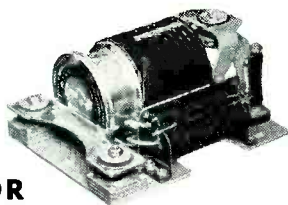

## —to save component items and critical materials

**Today** in many industries, commercial production is finding Federal Selenium Rectifiers of enormous value in keeping assembly lines on the move...through the replacing or supplanting of component items... through the saving of critical materials.

These versatile power conversion units are rapidly taking the place of rectifier tubes...television and radio transformers...rotating machinery for supplying DC for electroplating, battery charging, welding and numerous other applications...larger and more complicated equipment used in magnetic amplifiers.

When you specify Federal Selenium Rectifiers to save space and weight...to obtain increased efficiency, dependability and economy...you can be sure of the best obtainable. And you can be sure that Federal engineers will give you the full benefit of their more than a decade of experience in Selenium Rectifier design.

## "Federal"—First Name in Rectifiers for the "Front Line of Design"

**Millions** of Federal Selenium Rectifiers are now successfully performing hundreds of power conversion jobs in vital applications...from aircraft to submarines...in both industrial and commercial products...in sizes ranging from subminiature special equipment to heavy duty power supplies.

Whatever your AC to DC power conversion requirements, get in touch with a Federal engineer today. He has complete information on the Selenium Rectifier that you need. Write to Dept. F-313.



*Federal Telephone and Radio Corporation*



SELENIUM and INTELIN DIVISION, 100 Kingsland Road, Clifton, New Jersey

In Canada: Federal Electric Manufacturing Company, Ltd., Montreal, P. Q.  
Export Distributors: International Standard Electric Corp., 67 Broad St., N. Y.



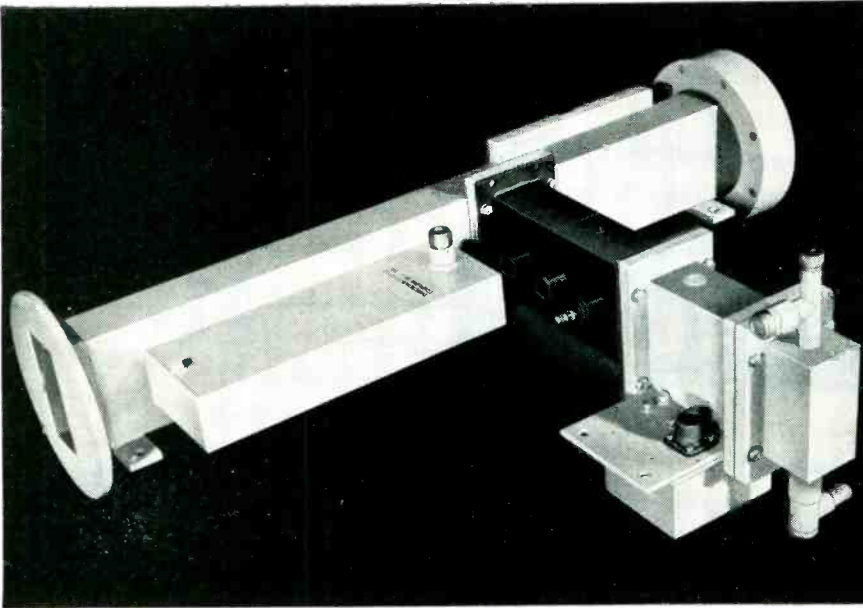

## Duplexer · Mixer · Coupler · Shutter...

by

**Terpening**

This duplexer-mixer, with its directional coupler, protective "shutter," TR and ATR connections, for high-power operation in S-band, was designed in our labs to comply with performance specifications for SWR, attenuation, etc., and produced in quantity in our shops.

This is another example of the type of help Terpening is set up to provide prime contractors on microwave transmission line systems—from design through production. Though all of the components we manufacture currently are made to order, we do have a limited stock of some special components which might just happen to fit your requirements.

In any event, although our engineering staff, laboratories, and fully equipped shop are busy with government contracts, we will be happy to talk with you about your needs on similar work.

See us at the show—Booth No. 373



**L. H. TERPENING COMPANY**

DESIGN • RESEARCH • PRODUCTION

Microwave Transmission Lines and Associated Components

16 West 61st St. • New York 23, N. Y. • Circle 6-4760

model CR-30 cathode-ray tube tester, a complete, self-contained instrument that will test all tv picture tubes (electrostatic as well as electromagnetic), scope tubes and industrial c-r tubes. It performs such tests without removing the tube from a tv set or tube carton. Designed to eliminate guesswork in determining tube quality, the unit has test parameters based on true beam current (proportionate picture brightness) principles. A voltage-regulated, bridge-type vtvm provides c-r tube quality indications. With test circuits at high-sensitivity position, a beam current change of only 0.1  $\mu$ a will create a change in meter indication of approximately five divisions on the 120-division scale.

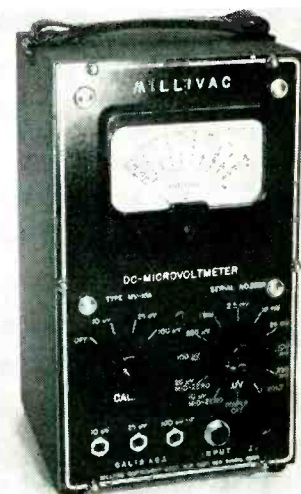

### D-C Microvolt Meter

MILLIVAC INSTRUMENT CORP., Box 3027, New Haven, Conn. The MV-15A d-c microvolt meter has a full scale sensitivity of 10  $\mu$ v with an input impedance of 1,000 ohms. It incorporates a new modulator that not only increases the sensitivity of d-c carrier-type amplifiers, but, in addition, eliminates to a considerable extent contact hazards commonly found in ordinary chopper circuits. Among the meter's more important applications are delicate temperature measurements, geophysics, meteorology, medical research, slowly changing strains and stresses, null detection in extremely sensitive bridges, chemical research and nuclear research as well as measurement of the output

# HOW ALDEN CAN HELP YOU IN THE DAYS AHEAD

Now, more than ever, it is tremendously important that each component on your line fall into place with maximum ease and speed, using a minimum of highly skilled labor. Don't eat up thousands of precious man-hours with bulky, awkward parts that slow down and often stop an entire assembly line. . . . Don't get stuck with an impossible design that needlessly taxes the patience and skill of assemblers, and which, when finally assembled, presents further problems of check and service.

It is extremely necessary in the critical days ahead to hurdle production pitfalls and produce the best and fastest way possible. Using components of ALDEN Design will help you to avoid stumbling blocks and bottlenecks of bulky, poorly engineered components and enable you to manufacture equipment with maximum ease and efficiency.

To get real production design, one has to know and appreciate the production problems—For over 15 years we have been engineering and manufacturing electrical and electronic components that have become standard for many applications because of both good engineering principles and practical working production design. We use these components in many of our own designs; therefore we actually anticipate and take into consideration the end use. We test and judge each new component by how it will save you time, material, and money; how it will add to the performance of your product; and how it will fall into standard production assembly techniques.

ALDEN is set up with extremely flexible production facilities and has readily available many techniques not generally found under one roof. The diversity of skills and combined technical and practical knowledge of engineering and manufacturing enables us to supply you with a whole series of components production designed to prevent headaches and save valuable man-hours of engineering, planning, purchasing, and manufacturing departments.

Save time, save money, eliminate waste—Know ALDEN design.

Send for descriptive folder, "What's New at Alden's" . . . .

See us at Booth N-3 The I.R.E. Show



**ALDEN PRODUCTS COMPANY**

117 N. Main St., Brockton 64E, Mass.

## PLUG-IN COMPONENTS

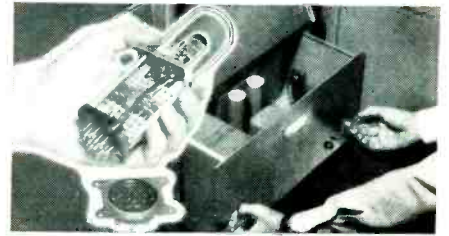

ALDEN is pioneering a whole series of components for plug-in unit construction. . . . Accessible, back connected, slide-in lock-in chassis, rugged color-coded back connectors for slide-in plug-in chassis, dress up housing and rugged bases for plug-in units, and quick acting, easily operable fastenings and locks for plug-in units. ALDEN design is tremendously popular and is fast becoming the standard for plug-in construction.

Sturdy plug-in chassis design gives you quick and positive insertion and removal. ALDEN color-coded back connectors make and break electrical connections smoothly and efficiently—rapid check, service and changeover of chassis unit is completed with ease.

Extremely flexible plug-in kits allow you to design circuits and mount components as ultra-compact plug-in units . . . on a production assembly basis.

## TOP CONNECTED CONTACT CONNECTORS

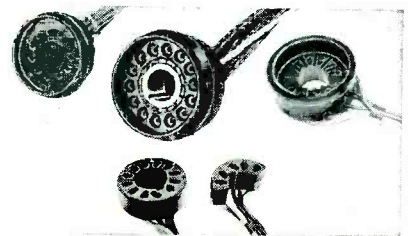

Here are connectors that you can't afford not to be acquainted with. From single wire to multi-wire connectors you get these exclusive performance design features. ALDEN famous top connected contacts which allow ultra compact connector design requiring less space, less material—lead is attached directly to forward end of the contact; No metal is wasted; No bulky housing is necessary. 100% molded insulation around each clip and lead—no danger of insulation pull-back and no need of insulating tubing around wiring. Individual strain relief on each lead—lead held without the use of cable clamps or Underwriters' knot. Wire is crimped firmly to contact at solder joint and capillary action gives perfect connections without danger of cold solder joint.

## COMPUTER COMPONENTS

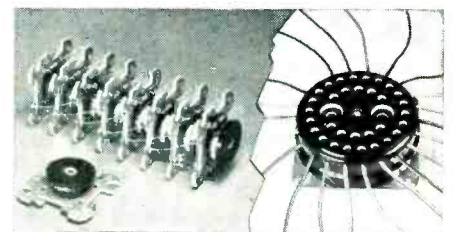

Imagination and ingenuity—skill and production facilities are combined at ALDEN to manufacture computer components that are standard production items. ALDEN is working with laboratories and other manufacturers developing computer components—taking them from the idea stage, designing them into components embodying working production design principles and getting into volume manufacture.

Recent developments include a multiple connection socket for the RCA SB256 Memory Tube and a new storage and pulse handling component, the Static Magnetic Memory, designed and manufactured in conjunction with the Harvard Computation Laboratory. ALDEN'S skill and ingenuity at setting up assembly line techniques greatly reduces costs and makes available practical components that permit the profitable application of many new ideas in the computer field.

## MINIATURIZED COMPONENTS

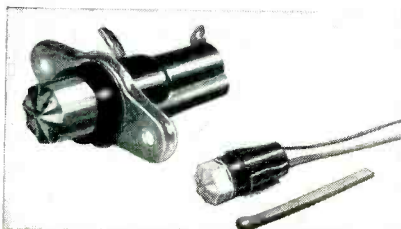

Squeeze without sacrificing efficiency or performance—ALDEN has long anticipated the trend to miniaturization and has been conducting extensive work for both government and commercial applications—already has a wide line of components developed which can become standard to help meet many of your limited space requirement needs. Connectors, indicator lights, fuseholders, terminals, plugs and sockets all take a minimum of space, and yet, good practical engineering design has eliminated possible assembly bottlenecks. Carefully designed ALDEN components readily fit into your production techniques using standard production tools.

## UNIT CABLING

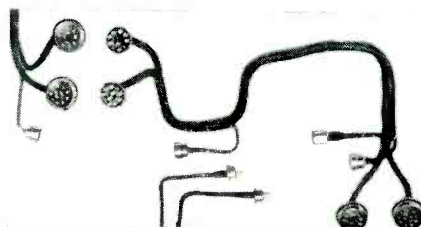

ALDEN performance proven unit cabling is designed specifically for the job it is to be used on. . . . Here is what ALDEN engineers do for you—take your prototype model, engineer to your specific requirements cables which incorporate years of technical design and development of connectors and wire services. You get cables that are economic and efficient units which allow instant continuity checks and rapid replacement in the field. ALDEN unit cabling solves the problems of malfunctions, time delays, excessive production costs and high service cost in the field caused by cables designed as an afterthought.



# DESIGN AND PRODUCTION FACILITIES ...NOW AVAILABLE

In the course of a current assignment, these components were developed. We invite inquiries regarding similar requirements where an unusual approach and exceptional engineering ability and material know-how are requisites.

NETWORKS • FILTERS • TRANSFORMERS • REACTORS

## ELECTRONIC COMPUTER Corp.

265 BUTLER STREET, BROOKLYN 17, N. Y.

TRiangle 5-2324

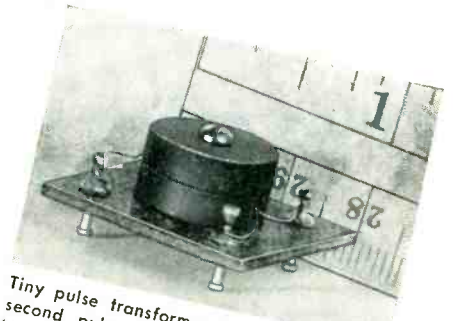

Tiny pulse transformer to couple 2 microsecond pulse from power amplifier tube to low impedance load. We can produce low power pulse transformers to reproduce pulses of widths ranging from a fraction of a microsecond to several milliseconds.

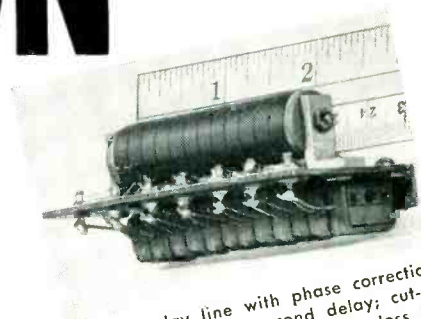

Lumped delay line with phase correction: 1750 ohm; 20 microsecond delay; cut-off frequency of 200 kc; 1/2 db power loss. We are prepared to make delay lines covering the audio and radio frequency spectrums.



Low-loss inductor: inductance = 1 henry;  $Q = 400$  at 30 kc. Extremely low-loss inductors and high-fidelity transformers are obtainable over a wide range of values and frequencies, using similar structures in various physical sizes.

of h-f vacuum thermocouples, bolometers and crystal diodes.

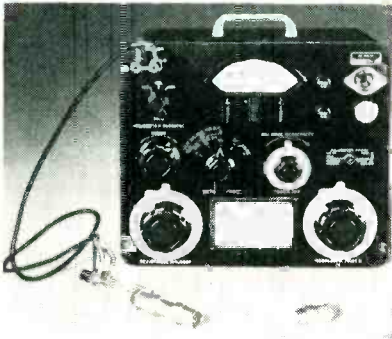

**General Purpose Bolometer Bridge**

GENERAL RADIO Co., 275 Massachusetts Ave., Cambridge 39, Mass. Type 1651-A bolometer bridge has been designed for maximum flexibility in application, so that it can be easily adapted to a variety of power measurement problems. It can be used with any bolometer having a resistance between 25 and 400 ohms. Measurements can be made either by a direct-reading or a substitution method. Current range is 0 to 100 ma; power range, 0 to 500 mw. It operates from the 60-cycle line and is priced at \$325.00 exclusive of bolometers.

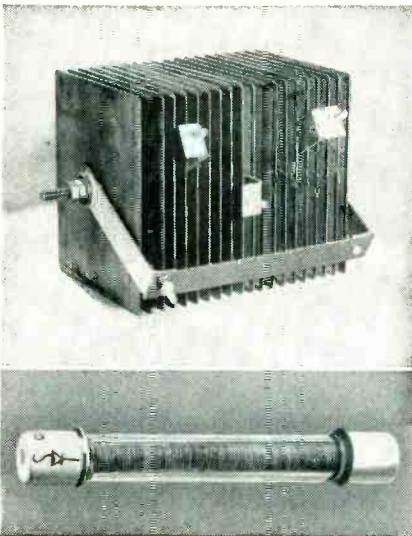

**Power & H-V Selenium Rectifiers**

SARKES TARZIAN INC., 415 North College Ave., Bloomington, Ind. Centre-Kooled power rectifiers are

**AIRBORNE High Frequency ANTENNAS**  
*are born in* **WORKSHOP LABORATORIES...**

For the U. S. Air Force rocket program, Workshop engineers have developed a unique antenna system. Strategic placement of flush-mounted slot antennas around the rocket provides essentially isotropic radiation for optimum reception by ground stations. The related problems of frequency, power distribution and phasing were solved by Workshop engineers to make this notable achievement.

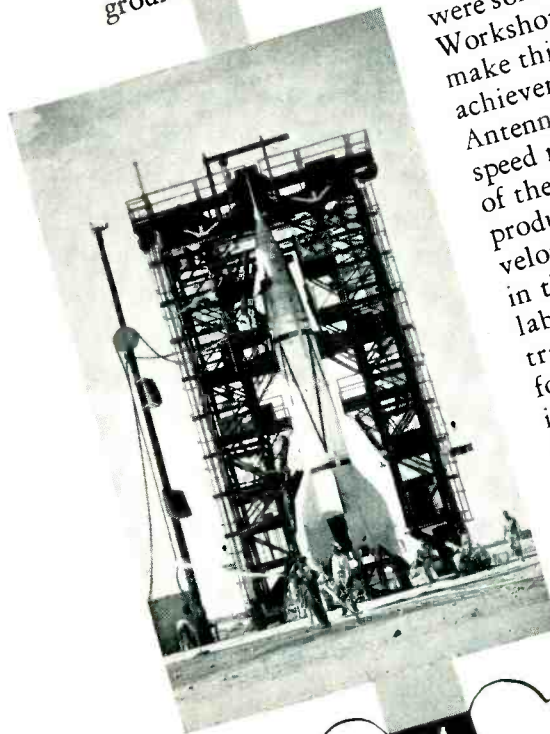

Antennas for high speed rockets are typical products being developed regularly in the Workshop laboratories. Under contracts with the armed forces and private industry, Workshop engineers constantly work to solve the most difficult antenna problems.

*Specialists in High Frequency*  *Antennas*  
**THE WORKSHOP ASSOCIATES, Inc.**  
 135 CRESCENT ROAD, NEEDHAM HEIGHTS 94, MASSACHUSETTS



**GOING TO MAKE NEW PRODUCTS SOON?**

We're Ready to Help  
with your  
**SPRING, COIL and  
WIREFORM**  
Problems

The shifting over to defense work can cause plenty of headaches. The old familiar problems of new specifications, shortages, manpower, equipment, schedules, etc., etc., are approaching us again. We can't help solve all your problems, but we probably can save you several aspirins when it comes to springs, coils and wireforms.

*What can Lewis offer you? . . .*

Extensive, modern facilities and equipment — experienced design and engineering personnel — skilled production workers — practical, economical manufacturing methods — unusual assistance in selecting the "right" springs for the job.

So, when you're ready, take advantage of the experienced help that Lewis Spring Engineers can offer — if possible, while your products are still in the blueprint stage. Phone, wire or write — no obligation.

**LEWIS SPRING & MANUFACTURING CO.**

2625 West North Avenue • Chicago 47, Ill.

**Lewis** PRECISION  
**SPRINGS**  
THE FINEST LIGHT SPRINGS AND WIREFORMS OF EVERY TYPE AND MATERIAL

available in 10 basic cell sizes and by employing series-parallel connections and combinations, any practical current and voltage range is attainable. Applications include battery charging, electroplating, railway signaling, aviation, elevator control and power supply, cathodic protection and wherever d-c is either required or desirable. High-voltage selenium rectifiers are available in two cell sizes with inverse voltage ratings to 5,000 v and d-c current ratings of 5 and 25 ma in half-wave circuits and 10 and 50 ma in full-wave circuits.

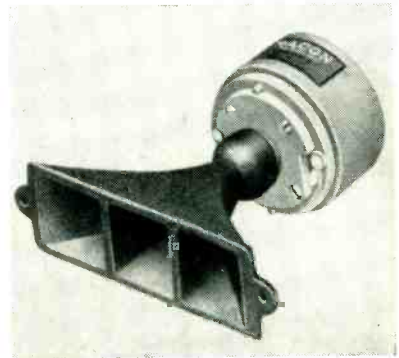

#### Wide-Range Tweeter

RACON ELECTRIC CO., INC., 52 East 19th St., New York 3, N. Y. Specially designed for high-quality wide-range audio systems, model CHU-5 tweeter provides clean and uniform response to 12,000 cycles, with excellent usable output to beyond 15,000 cycles. When used with a 12 to 15-in. cone speaker and proper network, it handles 25 to 30 watts of program material. Impedance is 15 ohms. List price is \$30.50.

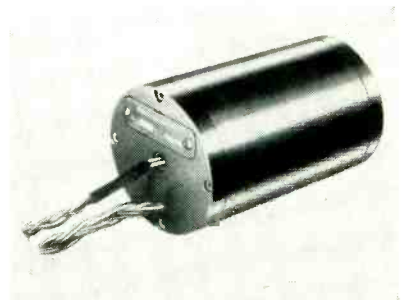

#### Phase Converter

FORD INSTRUMENT CO., DIVISION OF THE SPERRY CORP., Long Island City 1, N. Y., is producing a new, com-

# ELECTRONIC INSTRUMENTS

## AUDIO TO MICROWAVES

- SWEEPING OSCILLATORS
- MARKER OSCILLATORS
- FREQUENCY METERS
- ANALYZERS
- ATTENUATORS
- REFLECTOMETERS

Specialized Electronic Instruments for Civilian and Military Uses

See the MEGA-LINE and the SONA-LINE

AS EXHIBITED AT THE-



IF YOU ARE NOT ON OUR MAILING LIST, WRITE FOR OUR NEW CATALOG A51

ELECTRIC



COMPANY

25 Maple Avenue

Pine Brook, N. J.

Phone CAldwell 6-4000



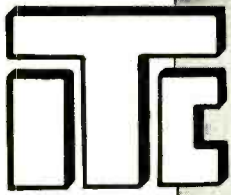

# INSTRUMENTS THAT BELONG IN *Your* LABORATORY

## TIC Type 310-A Z-Angle Meter — 30 to 20,000 c.p.s.

Measures impedance directly in polar coordinates as an impedance magnitude in ohms and phase angle in degrees  $Z/\pm \Theta$ . Measures, with equal ease, pure resistance, inductance, capacitance or complex impedances comprised of most any RLC combinations. Range: Impedance (Z), 0.5 to 100,000 ohms; Phase Angle ( $\Theta$ ),  $+90^\circ$  (Xl) through  $0^\circ$  (R) to  $-90^\circ$  (Xc). Accuracy: Within  $\pm 1\%$  for impedance and  $\pm 2^\circ$  for phase angle. Price: \$470.00.

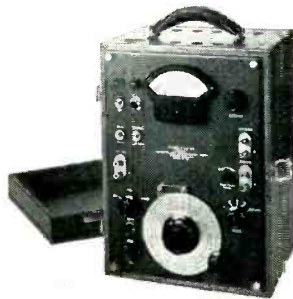
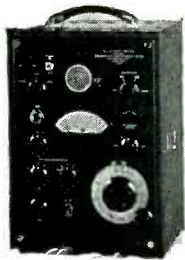

## TIC Type 311-A R-F Z-Angle Meter for radio frequencies — 100 kc to 2 mc.

Simplifies laboratory and field impedance and phase angle measurements. Ideal for checking impedance of coils, transformers, coupling networks, lines, filters, antennas, etc. Direct-reading Impedance Range: 10 to 5,000 ohms up to 200 kc, and 10 to 1,000 ohms at 1 mc. Phase Angle:  $+90^\circ$  (Xl) through  $0^\circ$  (R) to  $-90^\circ$  (Xc). Accuracy: Impedance to within  $\pm 3\%$ , and phase angle  $\pm 4^\circ$ . Price: \$385.00.

## TIC Type 410-A R-F Oscillator — 100 kc to 10 mc. (Special models 46.5 kc to 4.65 mc available.)

Power oscillator for use as bridge driver and general laboratory measurements. Features: High stability, high output (approximate 30 volts), 50-60  $\Omega$  output impedance, expanded frequency scale, direct reading output voltmeter, compact design. Price: \$385.00.



## TIC Type 320-A Phase Meter — frequency range 20 cycles to 100 kc.

The first commercially available all-electronic instrument that directly measures the phase angle between two voltages in a simple operation. Ideally suited to applications in such fields as audio facilities, ultrasonics, servomechanisms, geophysics, vibrations, acoustics and many others.

Phase angle readings made directly without balancing . . . stable at frequencies as low as 2 to 3 cycles. Voltage range: 1 to 170 peak volts. Terminals for recorder . . . choice of relay-rack or cabinet mounting. Price \$525.00. Cabinet \$25.00.

## TIC Type 500-A Wide Band Decade Amplifier

Designed for use with the phase meter at voltage levels below one volt and as a general purpose laboratory amplifier—features high gain negligible phase shift and wide band width. Unique circuitry—which employs three cathode followers—offers wider frequency range, higher input impedance and lower output impedance than other types. Panel switch selects proper feedback compensation when either optimum amplification or phase shift operation is desired.

Outstanding specifications: Amplification—10; 100; 1000 selected by rotary switch . . . Accuracy  $\pm 2\%$  nominal . . . Frequency response— $\pm 0.5$ db from 5 cycles to 2 mc on gain of 10;  $\pm 0.5$ db on 5 cycles to 1.5mc on gain of 100;  $\pm 0.8$ db from 5 cycles to 1mc on gain of 1000 . . . Phase shift  $-0 \pm 2^\circ$  from 20 cycles through 100Kc . . . Gain stability—constant with line voltages Kc (105-125v).

TECHNICAL CATALOG—yours for the asking. Contains detailed information on all TIC Instruments, Potentiometers and other equipment. Get your copy without obligation—write today.



Prices: Single Type 500-A in cabinet, \$205.00 (Rack mount, \$200.00): Dual Type 500-AR in cabinet, \$425.00.

compact phase converter which converts a primary 4-phase supply for multi-phase telemetering equipment. It is a nonrotating unit with movable primary for initial setting. Weighing 30 ounces, with an over-all length of 3.5 in. and a diameter of 2.25 in., it replaces bulkier transformers, with resultant space and weight saving. The outside shell is anodized to insure corrosion protection.

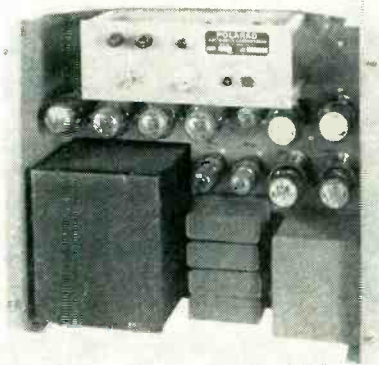

## Regulated Power Supply

POLARAD ELECTRONICS CORP., 100 Metropolitan Ave., Brooklyn 11, N. Y., announces the model PT-112 regulated power supply. The unit is designed to provide high current drain at precisely regulated voltages to meet the need of the television industry. It is adjustable from 250 to 300 volts and delivers in excess of 800 ma. Ripple is held to the extremely low levels required of tv applications. Regulation is better than 0.02 percent. Output impedance is less than  $1\frac{1}{2}$  ohms.

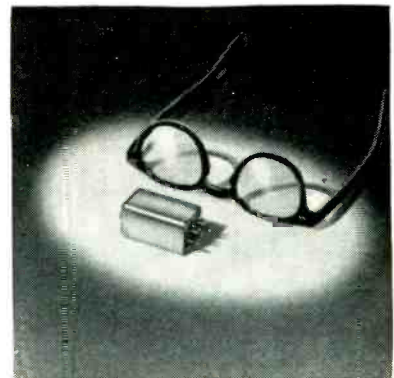

## Sensitive D-P Relay

SIGMA INSTRUMENTS, INC., Boston 21, Mass. The hermetically-sealed

# TIC TECHNOLOGY INSTRUMENT CORP.

531 Main Street, Acton 54, Massachusetts Tel. Acton 600

Engineering Representatives

Cleveland, Ohio—Prospect 1-6171 Manhasset, N. Y.—Manhasset 7-3424 Chicago, Ill.—Uptown 8-1141 Boonton, N. J.—Boonton 8-309; Rochester, N. Y.—Monroe 3143 Cambridge, Mass.—Eliot 4-1751 Canaan, Conn.—Canaan 649 Hollywood, Cal.—Hollywood 9-6305 Dayton, Ohio—Michigan 8721, Dallas, Texas—Dixon 9918

**DeJUR** makes great little meters . . .

## Panel Meters

- Miniature 1 1/2" square
- Waterproof sealed
- Obtainable with Lucite scales and Magnetic Shielding

Larger sizes available  
 2 1/2" round  
 2 1/2" square  
 3 1/2" round  
 3 1/2" square  
 4" square

JAN-1-6 and A.S.A. specifications

Built to Conform to Forthcoming JAN Spec. for 1 1/2" Meters

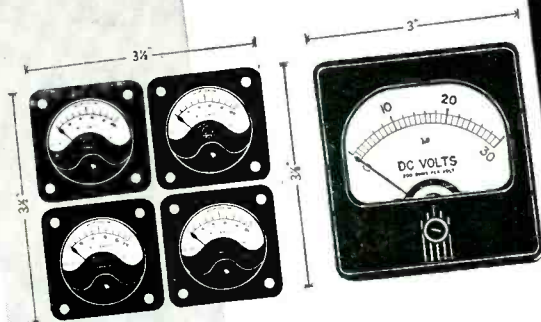

## PRECISION *Potentiometers*

### BRAND-NEW MODEL L-400

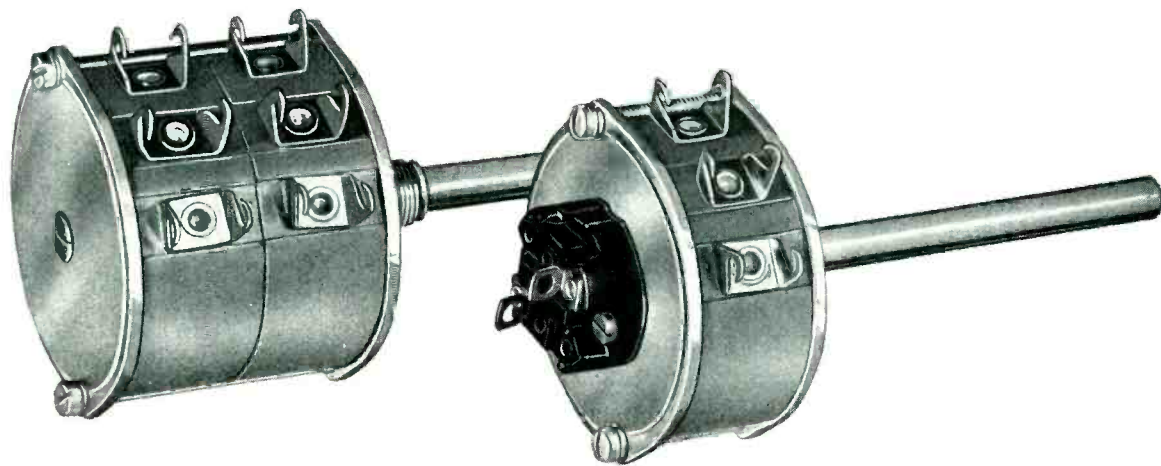

#### FEATURES

- 1 5/8" diameter
- 3 watts
- Fully Enclosed
- Linearity Accuracy-Standard 0.5% (0.3% on order)
- Available with or without switch
- Designed for easy ganging
- Double end shaft available
- Will meet JAN-R-19 Specs

Drop in to see us at our factory.  
 We're just across the bridge. Take IND subway to 46th Street, Long Island City.



**DeJUR**

**AMSCO CORPORATION**

45-01 NORTHERN BOULEVARD, L. I. C. 1, N. Y.

MANUFACTURERS OF SCIENTIFIC PRECISION EQUIPMENT FOR OVER A QUARTER OF A CENTURY



# STANDARD SIGNAL GENERATOR

Type TF 867

On show  
at the  
I.R.E  
Convention



Because its superiority is unchallenged, Signal Generator type TF 867 is in a class by itself. Especially noteworthy are an expanded wide-view scale covering 15 kc/s to 30 Mc/s and a concentric terminating unit which, while showing exact circuit conditions on an animated diagram is also a dummy aerial and impedance source of various values. Other facilities include crystal standardisation, freedom from unwanted frequency modulation, deep amplitude modulation measured on a true modulation monitoring circuit and an output automatically stabilised regardless of tuning and line fluctuations. Output is variable from 4V to  $0.4\mu\text{V}$  and calibration indicates the true artificial signal e.m.f. irrespective of load.

*This instrument is but one of a wide range which includes signal generators, f.m. and a.m., covering up to 600 Mc/s, a.f. sources, v.t. voltmeters, bridges, frequency standards etc. Please write for full data by return mail.*

**MARCONI INSTRUMENTS LIMITED**  
23/25 Beaver Street, New York, 4

CANADA: CANADIAN MARCONI LIMITED, Marconi Building, St. Sacrament St., Montreal.  
ENGLAND: St. Albans, Herts.

d-p relay illustrated measures 1 in. square by  $1\frac{1}{2}$  in. high, exclusive of the terminals. Sensitivity is approximately 40 mw. Such relays withstand better than 10 g vibration at frequencies in excess of 60 cps. When 2 to 1 margins for OPERATE and RELEASE current are provided the new miniature relay can be used under conditions of sustained acceleration as high as 50 g.

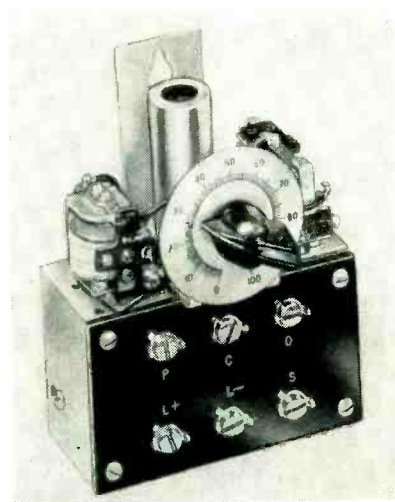

## Electronic Timer

FARMER ELECTRIC CO., 21 Mossfield Rd., Waban 68, Mass. Model CK electronic timer overcomes the need for frequent tube replacement by use of the type 5823 cold-cathode tube. A further advantage is the ability to recycle the timer immediately. Four time ranges are available: 1.5, 3, 6 or 12 seconds; and a dial with 100 graduations allows the unit to be set for any desired percentage of the total range. The timer operates directly from 10 to 125 volts, 60 cycles. Its load control relay handles 8 amperes noninductive load at 125 volts a-c, in a spdt circuit with no intermediate OFF.

## Resistance-Wire Strain Gage

BALDWIN LOCOMOTIVE WORKS, Philadelphia 42, Pa. Type SR-4R bonded resistance wire strain gage is self-compensated for temperature variation. Its principal advantage is elimination of a second strain gage to compensate for tem-

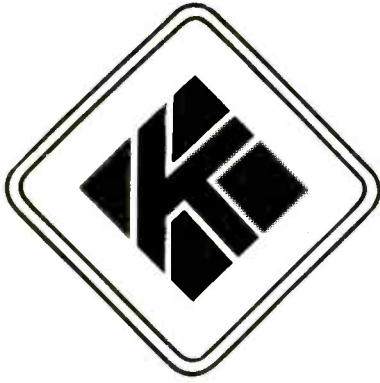

*Leading the Quality Field for more than 25 Years*

# **KENYON TRANSFORMERS**

**for all ARMY-NAVY specifications**

- built for durability
- engineered for trouble-free operation
- designed for standard and special applications

**use KENYON TRANSFORMERS for**  
**RADAR • BROADCAST • SPECIAL MACHINERY**  
**JAN APPLICATIONS • ATOMIC ENERGY**  
**EQUIPMENT • AUTOMATIC CONTROLS**  
**EXPERIMENTAL WORK**

*Write for details*

**KENYON TRANSFORMER CO., Inc.**

**840 BARRY STREET • NEW YORK 59, N. Y.**



# Industrial Electro-mechanics



ALNICO  
MOTORS

ELECTRONIC  
RELAYS

MOTOR  
SPEED  
CONTROLS

AMPLIFIERS

POSITION  
SERVOS

D. C. MOTORS

VELOCITY  
SERVOS

RATE  
GENERATORS

INTEGRATORS

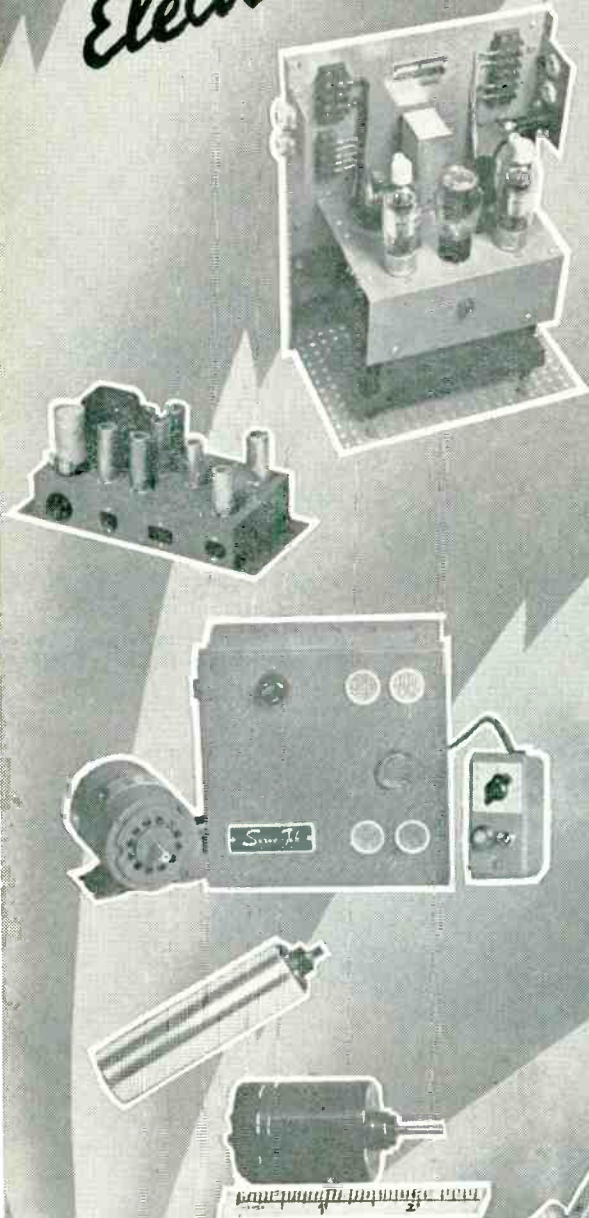

**Servo-Tek**  
products co.

4 GODWIN AVE. ARMORY 4-3366 PATERSON 1, N. J.

perature changes, thus saving application time and wiring. Basically, the new gage is similar to standard Bakelite gages with cupronickel wire and its application is by means of the same methods and phenol-resin cement. Gages for two temperature ranges are offered: 50 to 300 F and -50 to 300 F. Single-element gages for Dural or steel are available in four lengths:  $\frac{1}{4}$  in.,  $\frac{3}{8}$  in.,  $\frac{1}{2}$  in. and  $\frac{3}{4}$  in.

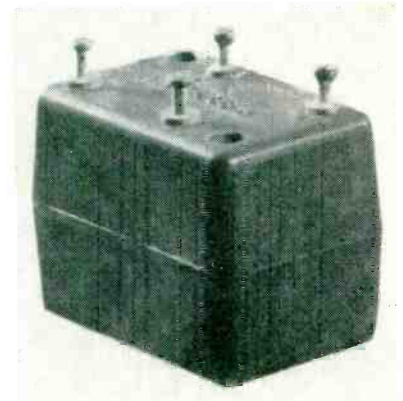

## Pulse Transformers

ENGINEERING RESEARCH ASSOCIATES, INC., 1902 W. Minnehaha Ave., St. Paul W4, Minn., is manufacturing a line of pulse transformers designed especially for circuits requiring low power applications. General applications include triggering and counting circuits and blocking oscillators. More specific uses are for d-c isolation, inversion, pulse shaping and pulse transmission circuits. Specifications for the entire line may be found in brochure PX29394.

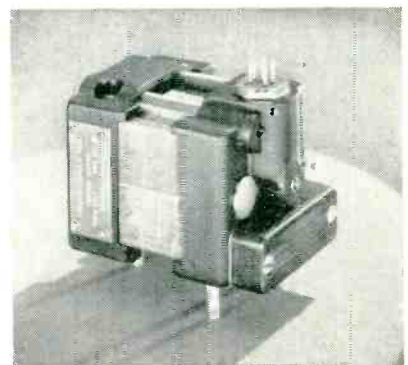

## Torque Motor

TRANS-SONICS, INC., Bedford Airport, Bedford, Mass. Type 35-1

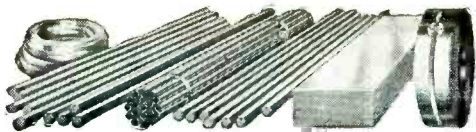

BRIDGEPORT BRASS COMPANY

# COPPER ALLOY BULLETIN



MILLS IN BRIDGEPORT, CONN. AND INDIANAPOLIS, IND.—IN CANADA: NORANDA COPPER AND BRASS LIMITED, MONTREAL

## Selling to Department of Defense —Army, Navy and Air Force

*The information contained on this page relative to selling to the Military Departments of the Department of Defense was obtained from the Munitions Board Small Business Office.*

Manufacturers, faced with material shortages and curtailment of civilian goods, are of necessity seeking defense orders to keep their plants operating. These do not come without effort on the part of the manufacturer.

However, a manufacturer may waste time seeking war orders through trips to Washington. Information, and eventually orders, can be obtained more quickly and easily by writing.

The Department of Defense, under which falls the Army, Navy and Air Force, has assigned to individual military departments responsibility to procure certain supplies and services for all three units.

At the same time the Army, Navy and Air Force have offices which buy for their individual needs.

### Get on "Bidders Lists" for Prime Contract Work

All of these offices have what is known as "bidders lists". The manufacturer should be on these lists to receive a chance to bid on a formally advertised contract or to be approached for a negotiated contract.

Wherever possible, the advertised method is used. However, negotiated contracts are permitted under the recently declared national emergency.

The Superintendent of Documents, U. S. Government Printing Office, Washington 25, D. C., has available three booklets. These publications list the purchasing offices of the Army, Navy and Air Force, and give a brief descriptive list of the items each purchases. The method of getting on "bidders lists" and the necessary steps in seeking contracts are also explained:

1. "How to Sell the U. S. Army" (30 cents).
2. "Purchasing Items and Purchasing Locations of the Department of the Navy" (20 cents).
3. "A Guide for Selling to the U. S. Air Force" (15 cents).

### IT'S YOUR JOB!

There is no easy way to do business with the Government. You must exercise just as much initiative, enterprise and salesmanship as you would in doing business with private industry.

Another service is available to manufacturers for information as to the purchasing office to write to for a specific product or products. A letter listing products you are making or can make should be addressed to:

The Military Procurement  
Information Office  
Munitions Board  
The Pentagon  
Washington 25, D. C.

Information as to specific offices to contact for getting on bidders lists will be sent to you. This office will also answer questions pertaining to defense orders.

When you have obtained the name and address of the office, or offices, interested in procuring your goods, a simple letter, illustrated on this page, will either put your company's name on the bidders list or bring application blanks.

### Daily Listing

As an aid to businessmen in obtaining current information as to what the Government is purchasing, and an opportunity to bid, the U. S. Department of Commerce publishes daily a "Consolidated Synopsis of U. S. Government Procurement Information." It lists the purchasing office making the

procurement, the item contemplated and the amount, the invitation for bid number, and the bid opening date. A firm may bid on any item listed by writing to the office doing the buying, giving the IFB number, and requesting a bidding set.

### Sub-contract Work

Up to this point only prime contracts have been discussed. There are, however, many concerns who can handle, or desire, only sub-contract work such as screw machine, press, tool shops, etc.

To facilitate small business in obtaining the names of the firms awarded unclassified Department of Defense contracts in amounts over \$25,000, the Department of Commerce publishes weekly the "Consolidated Synopsis of Contract Award Information." This gives the name and address of the successful bidder, the commodity purchased, the quantity, and the value.

Both contract award and procurement information synopsis may be reviewed at your local Chamber of Commerce or nearest field office of the U. S. Department of Commerce. If you wish to receive these regularly write to:

U. S. Department of Commerce  
Division of Printing Services  
Washington 25, D. C.

### Suggested Letter Seeking Bids

(Company Letterhead)

Commanding Officer  
(Purchasing Office)  
(City, State)

Dear Sir:

Our firm is desirous of supplying items centrally procured through your office, as outlined in pamphlet "How to Sell to the United States Army" and/or "Purchasing Items and Purchasing Locations of the Department of the Navy", and/or "A Guide for Selling to the U. S. Air Force".

Attached hereto is a list in duplicate of items which we desire to furnish. Where known, we have also indicated the applicable Government specification.

As we have never before bid on business through your office, we are attaching a copy of our most recent balance sheet, and profit and loss statement.

It is recognized that your office is extremely busy under the impact of procurement necessitated by the present emergency. No formal reply is requested, however, we would like the duplicate list returned to us in the enclosed self-addressed stamped envelope. Please mark any items that are not procured by your office, and if possible indicate the appropriate purchasing office.

Yours truly,





**MOLDITE  
RF FILTER  
CORES**

... when it's a  
matter of the *absolute*  
in precision design!

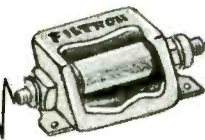

Specify  
**"CORES BY  
MOLDITE"**

Whether it's a filter for electronic controls, actuators, motors, or generators — from 14 KC to 1,000 MC—MOLDITE core specialists are compounding the mix, establishing the design to meet every RF filter core requirement. Years of MOLDITE know-how assure volume production, on time, with absolute sustained accuracy. Let us show you how MOLDITE can help you meet your defense contract specifications, too!

**NATIONAL**

**MOLDITE**

**COMPANY**

1410 Chestnut Ave., Hillside 5, N. J.

Samples promptly  
submitted upon request  
for design, pre-production,  
and test purposes

SEND FOR CATALOG 108

Jerry Golten Co.  
2750 W. North Ave.  
Chicago 22, Ill.

Martin P. Andrews  
Mott Road  
Fayetteville, N. Y.

Perlmuth-Colman & Associates  
1335 South Flower  
Los Angeles, Cal.

Jose Luis Pontet  
Cardoba 1472  
Buenos Aires

torque motor is an electromechanical device that uses an electrical current to produce a backlash-free translational motion, such as is suitable for displacing the piston on a hydraulic amplifier. By utilizing this torque motor design, electrohydraulic servomechanisms with natural frequencies as high as 100 cps have been constructed. The unit provides a linear motion of  $\pm 0.004$  in. and will move approximately 0.001 in. per ma of signal current. The locked rotor force output is 4 pounds for a differential current of 5 ma. The input may be connected directly to the plate circuit of a push-pull amplifier, and a pair of subminiature vacuum tubes are sufficient to provide full output from the motor.



**Power Triode**

FEDERAL TELEPHONE AND RADIO CORP., 100 Kingsland Road, Clifton, N. J. The F-5512 power triode is designed for use in high-powered tv and f-m broadcasting, cyclotron or synchrotron oscillators, and industrial h-f heating equipment. It operates in the 88 to 108-mc range. The anode is fabricated from oxygen-free, high-conductivity, heavy-wall copper, which allows a more uniform heat distribution and higher dissipation than a thin-wall anode. High mutual conductance makes it possible to obtain 25-kv output at 7.5 kv, eliminating the high cost of 10 or 15-kv rectifiers usually associated with high-power

# SPEED UP



You'll collect data more quickly, simply, objectively . . . with the help of Panoramic instruments. Unexcelled for laboratory, research and production applications requiring spectrum or waveform analysis.

Spectral components are seen graphically on a cathode-ray tube as sharp vertical deflections distributed horizontally in order of frequency. Deflection height directly indicates component or signal level.

Whatever your problem—analyzing waveform distortions, noises, characteristics of AM, FM or pulsed signals, vibrations, spurious oscillations or modulation, response characteristics of filters or transmission lines or monitoring many frequency channels simultaneously—you'll find a Panoramic analyzer to answer your needs.

● Complete Display of these and other Panoramic instruments in operation at the

**IRE SHOW  
BOOTH #N-6**

## PANORAMIC

RADIO



PRODUCTS INC.



10 SOUTH SECOND AVENUE, MOUNT VERNON, N. Y.

## SPECTRUM ANALYSIS FROM AF TO UHF with easier-to-use PANORAMIC INSTRUMENTS

### PANORAMIC SONIC RESPONSE INDICATOR G-2 for More Accurate Frequency Response Measurement

Used with Model AP-1, the G-2 allows visual inspection of the amplitude vs. frequency characteristic of systems in the range between 40 and 20,000 cps. May be used for research, development or production line testing of the frequency response characteristic of amplifiers, speakers, filters, transmission lines, receivers.

The G-2 is advantageous for study of systems in which the presence of noise or non-fundamental components obscure or distort the output at the exploring frequency.

Calibrated log frequency scale

Linear or log (60 db range) amplitude scale.

Slow, 1 cps sweep rate

10-step attenuator with 100 db range selects output voltages between 50 microvolts and 5 volts.

3 selectable output impedances; 10 $\Omega$  ohms; 500 ohms; 3000 ohms

### PANORAMIC SONIC ANALYZER, MODEL AP-1 Automatic Waveform Analysis in Only 1 Second

Here is your answer for truly simple high speed analysis of vibrations, harmonics, noises, acoustics and inter-modulation under static or dynamic conditions. AP-1 automatically separates and measures frequency and magnitude of complex audio wave components.

Frequency Range . . . . . 40-20,000 cps, log scale  
Input Voltage Range . . . . . 500uV-500V  
Voltage Scale . . . . . Linear and two decade Log  
Resolution . . . . . Optimum throughout frequency range  
Presentations easily photographed or recorded. Can be calibrated for determining level of individual sound or vibrational components.

### PANORAMIC ULTRASONIC ANALYZER, MODEL SB-7 A New Direct Reading Spectrum Analyzer

An invaluable instrument for channel monitoring, telemetering, medical studies, and for investigating ultrasonic waveform content and ultra audible noises and vibrations, the SB-7 allows overall observation of a 200 KC wide band or highly detailed examination of selected narrow bands.

Frequency Range: 2KC-300KC, linear scale  
Scanning Width: Continuously variable, 200KC to zero  
Amplitude Scale: Linear and two decade Log.  
Input Voltage Range: 1mV-50V  
Resolution: Continuously variable from 2KC to better than 500 CPS.

### PANADAPTOR, SA-8 PANALYZOR SB-8 For RF Spectrum Analysis where Maximum Resolution is a "Must"

Available in several types with maximum scanning widths ranging from 200 KC to 10MC, both the SA-8 and SB-8 feature . . . . .

- Continuously Variable Resolution from 100KC to 100cps
- Synchronous and Non-synchronous Scanning
- Long Persistence Displays plus Intensity Grid Modulation for Analysis of Pulsed RF Signals
- Continuously Variable Scanning Width from Maximum to Zero

### PANADAPTOR SA-3, SA-6 PANALYZOR SB-3, SB-6 For General RF Spectrum Analysis

Recognized as the fastest and simplest means of investigating and solving such RF problems as frequency stability, modulation characteristics, oscillations, parasitics and monitoring under static or dynamic conditions, these models are available in over a dozen different types, designed to meet your particular application.

Panadaptor units operate with superheterodyne receivers which tune in the spectrum segment to be observed.

Panalyzors use an external signal generator for this purpose and have a flat response for determining relative levels of signals.

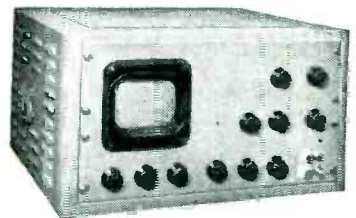
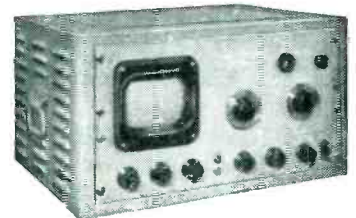
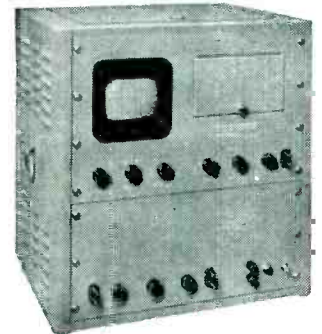

WRITE TODAY FOR COMPLETE SPECIFICATIONS AND PRICES



# VARIAN MICROWAVE ENGINEERING

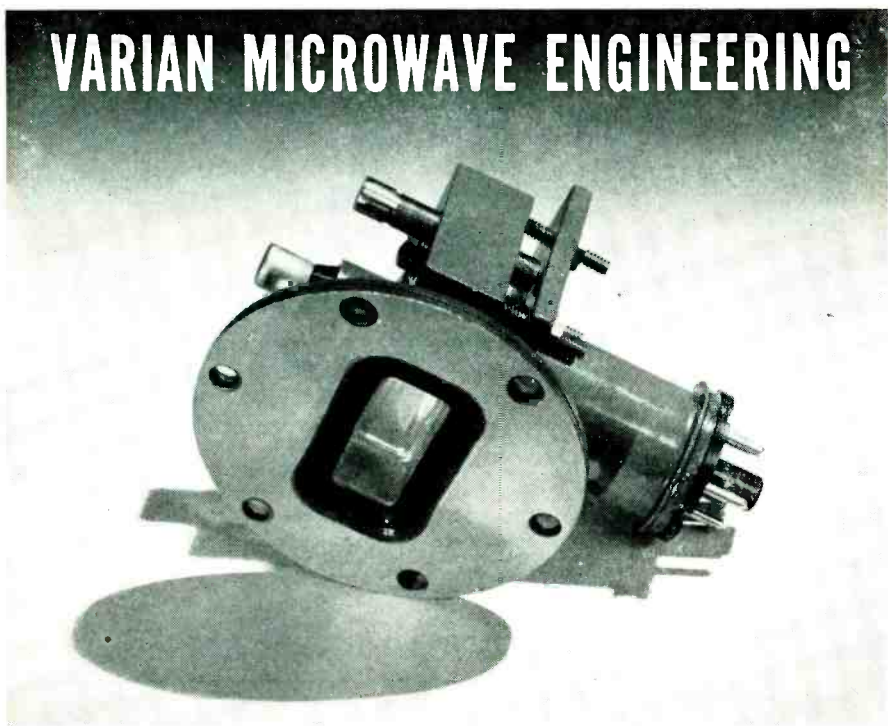

## ... produces a series of relay-link reflex klystrons

Following the modern design of other Varian waveguide-output klystrons designed for use with a matched load, this new series is engineered for uniform and stable characteristics, long life and low distortion. Intended primarily for broadband relay-link transmitter and local oscillator service, any one tube can cover a larger range with reduced performance.

Two production X-26 klystrons cover the frequency range from 6575 to 7425; four additional tubes under development complete the frequency range from 5925 to 7725 mc, each covering 300 mc. Additional tubes for frequencies up to 8200 mc can be produced to order.

High uniformity in each type and high performance characteristics are combined with simplicity of adjustments in service replacement.

### TENTATIVE SPECIFICATIONS

#### Electrical Characteristics

Beam Voltage, max volts	750
Beam Current, ma max	80
Heater Voltage, volts	6.3
Heater Current	0.8
Reflector Voltage, volts	0 to -1000
Power Output, watts min	0.5
Load VSWR, max	1.1

#### Typical Performance, X-26B

Frequency, mc	7425
Beam Voltage, volts	750
Beam Current, ma	70
Reflector Voltage, volts	350
Power Output, watts	0.75
Load VSWR, less than	1.1
Modulation Bandwidth, mc	33
Modulation Distortion at $\pm 3$ mc deviation, db	-40
Temperature Coefficient, mc per deg C, less than	0.07

NOW also in production, for television relay service, the Varian X-17 klystron. It covers the frequency range 1990 to 2100 mc with 5 watts minimum output power.

NEW PRODUCTS

(continued)

tubes. Filament current is 435 amperes at 6.2 v.

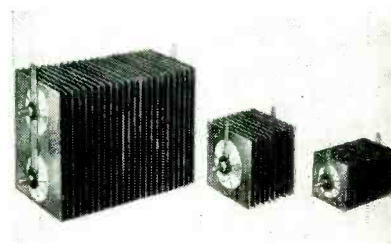

### Selenium Rectifiers

SYNTRON Co., Box 220, Homer City, Pa., is producing a line of selenium rectifiers made by a vacuum process that insures a smooth uniform selenium film, free from flaws, and permits thicker deposits of selenium and the production of larger cells than have been practical heretofore. Cells are available in 16 standard sizes. Rectifier stacks are arranged in various circuits depending on the d-c voltage and current requirements and the a-c supply voltage.



### Ionizing Flash Lamp

KEMLITE LABORATORIES, 1819 W. Grand Ave., Chicago 22, Ill., has developed a new low-voltage electronic ionizing flash lamp for use with units in the repeating photo-flash and stroboscopic fields. Of the gaseous ionizing type, it achieves intense light output by temporary

**VARIAN**  
associates

99 washington st.  
san carlos, calif.

electronic disturbance of inert gas molecules rather than by the filament burning process common to incandescent lamps. This so-called cold light is gained without material loss or destruction and, consequently, useful life is extreme and virtually constant in effect.

### Precision Regulator

WESTINGHOUSE ELECTRIC CORP., 306 Fourth Ave., Pittsburgh 30, Pa. The Microsyn precision regulator can perform the following operations: (a) produce a voltage proportional to turning a rotor over a range of  $\pm 10$  deg. with a sensitivity of 20 seconds; (b) produce a torque that is linear with the square of a signal current; and (c) act as an elastic restraint generator, producing a torque proportional to the product of the square of a current and the angular displacement. The magnetic structure is of Hipernik specially processed to give a hysteresis loop of small area, and a permeability of 100,000 with 0.03-oersted coercive force.

### Variable Capacitors

JFD MFG. CO., INC., 6101 Sixteenth Ave., Brooklyn 4, N. Y. The new piston-type variable trimmer capacitors are tubular in design and deliver continually uniform change of capacitance in relation to rotation. Only 1 in. in length, they offer maximum space economy with ease of mounting. Other features include: approximately zero temperature coefficient; Q rating of over 1,000 at 1 mc; 55C to  $-100$ C operating temperature; 10,000 megohms insulation resistance. The capacitors offer engineers, experimenters, technicians and designers the unusually low capacities needed especially in the operation of commercial and government land and marine communications and microwave equipment.

### Literature

V-T Electrometer. Keithley Instruments, 1507 Warrensville Cen-

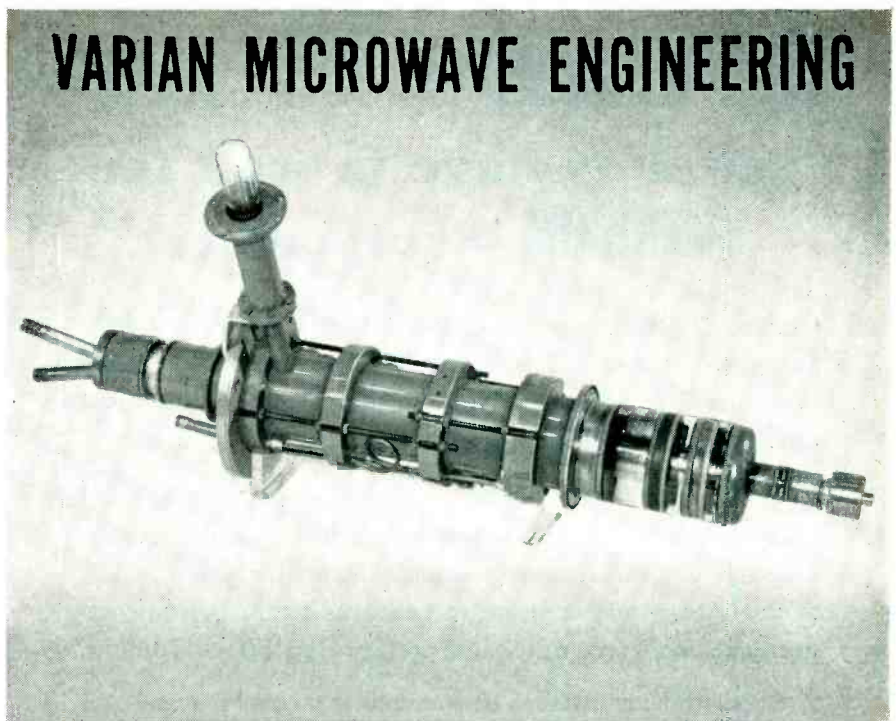

## ... develops a new 5-kw linear-amplifier klystron

Operating in the final stage of a uhf transmitter, the new X-25 Varian Klystron provides continuous output power up to 5 kw with approximately 15-w drive. The tube is tunable from 1016 to 1056 mc and has a half-power bandwidth of about 2 mc. Gain of approximately 27 db is essentially linear to 80 per cent of maximum output.

Particularly suited to applications where crystal control and/or low-level modulation are used, the new X-25 introduces sidebands 60 db or more below the carrier and negligible noise or spurious modulation.

Long service life has been attained by use of a bombarded tantalum cathode, part of an assembly which can be replaced easily in case of accident or failure. A cascade amplifier with three cavities, the new design lends itself to stagger-tuning and other methods of broad-banding. It is typical of amplifiers practicable for other frequencies in this band.

#### TENTATIVE SPECIFICATIONS

##### Typical Operating Characteristics

Beam Voltage, kv	12
Beam Current, amp	1.6
Power Output, max kw	5
Linear Output, max kw	4
Gain, db	27
Frequency, mc	1016-1056
Bandwidth, mc	2
Spurious Sidebands, db	-60

##### Mechanical Characteristics

Length, overall, in.	42
Weight, approx lb	60
Input Connection	Type N
Output Connection	Probe to feed 4-in. by 8-in. waveguide
Focussing	Magnetic
Cooling	Water and Air

For use on Cheyenne Mountain in Colorado, the X-25 was developed as part of the Varian-Engineered transmitter for the National Bureau of Standards. As part of a long-range program, the equipment will be operated 24 hours a day to provide propagation data on radio waves.

**VARIAN**  
associates

99 washington st.  
san carlos, calif.



# HERE'S WHY

## you may have to wait for AEROCOM Equipment...

On June 27, 1950, Aerocom was humming along — smoothly geared to the needs of its customers...filling orders as rapidly as required. After Korea, volume of orders rapidly increased to a level far beyond normal.

As this is written, it takes up to six months to fill DO rated orders for high-quality Aerocom equipment. Aerocom suggests that you anticipate your needs as far ahead as possible, so that you may continue to be served by the best in communications, electronic, and meteorological equipment.

CONSULTANTS, DESIGNERS AND MANUFACTURERS OF STANDARD OR SPECIAL ELECTRONIC, METEOROLOGICAL AND COMMUNICATIONS EQUIPMENT



# DANDUX

Canvas & Leather Products



- BAGS and CASES
- BG BAGS
- CW BAGS
- RADIO EQUIPMENT
- ELECTRONIC EQUIPMENT
- RADAR EQUIPMENT
- TOOL ROLLS

**C. R. DANIELS, INC.**

75 West St., New York 6, N. Y.  
549 W. Randolph St., Chicago 6, Ill.



## ELECTROLYTIC CAPACITORS

Consecrated  
to Quality Output and  
Golden Rule Service

*Because of LONGER LIFE on the job . . . because of compactness, easy mountability and perfect compliance with today's set-engineering requirements . . . these dependable Electrolytic Capacitors are rapidly becoming a MUST with leading radio and television manufacturers. We believe they belong in YOUR plans for 1951. Get acquainted with them, and the rest of the extensive ASTRON line.*

WRITE FOR CATALOG AC-2



**ASTRON CORPORATION** 255 Grant Ave., East Newark, N. J.  
Manufacturers  
HIGH QUALITY FIXED CAPACITORS AND FILTERS



## SPECIALTY

### LAB-BILT DRY BATTERIES

Write for New  
**FREE CATALOG**

Here are complete descriptions of 78 Lab-Bilt Batteries of industrial and hard-to-get types. Specification Sheet enables you to order batteries especially designed to your own requirements. No order is too small. Specialty makes and ships FRESH Lab-Bilt Batteries without delay. Get this new catalog today.



**INDUSTRY**



**LABORATORY**



**RADIO AND IGNITION**

**SPECIALTY BATTERY COMPANY**

Roy-O-Vac **RAY-O-VAC** Subsidiary

MADISON 10, WISCONSIN

ter Road, Cleveland 21, Ohio. A recent 4-page folder covers the model 200 vacuum-tube electrometer, a self-contained d-c voltmeter that has an extremely high input impedance. The unit described measures voltages on two ranges, 2 v and 20 v full scale, and has an input grid drift current of less than  $5 \times 10^{-14}$  and  $5 \times 10^{-13}$  ampere for the two scales respectively; its input resistance being greater than  $10^{14}$  ohms, and the capacitance approximately 6  $\mu\text{mf}$ .

**Electromagnet.** Arthur D. Little, Inc., 30 Memorial Drive, Cambridge 42, Mass., has published a 4-page folder dealing with its versatile electromagnet, a new research tool for producing high flux density magnetic fields. Illustrations, typical characteristics, outstanding features and research applications of the laboratory unit are shown.

**Subminiature F-M Transmitter.** Telemetering Associates, P. O. Box 6, Silver Springs, Md. A single-page bulletin describes the model T-1 subminiature f-m transmitter designed primarily for exacting telemetering applications. The unit treated consists of a triode oscillator, pentode reactance-tube modulator and a triode amplifier. Specifications and typical operation details are included.

**Sound Level Meter.** Dawe Instruments Ltd., 130 Uxbridge Road, Hanwell, London W7, England. Type 1400 sound level meter, a self-contained portable instrument giving a direct measurement of sound level over the full audible range, is illustrated and described in a recent single-sheet bulletin. Technical specifications are given and accessory equipment is described.

**Electrometer.** Loudon Instruments, Inc., 5644 Lake Park Ave., Chicago 37, Ill. A recent bulletin gives a very complete description, with specifications, of the model 361-20 electrometer, an instrument designed for measurement of small direct currents and voltages in high resistance circuits. Features making the unit described important for general laboratory appli-

**you're invited  
to our  
OPEN HOUSE**

**Bil Harrison, President**

**TO MEET THE MEN BEHIND  
HARRISON SERVICE!**

**Engineers, Purchasing Agents, Researchers, Executives, Production Chiefs . . . be our guests at our . . .**

**BIG 25th ANNIVERSARY  
OPEN HOUSE CELEBRATION,  
TUESDAY AND WEDNESDAY,  
MARCH 21 AND 22, FROM 9 A.M. TO 9 P.M.**

See **HARRISON RADIO** in action! See how **HARRISON** can save you time and money by supplying all your needs from a **SINGLE SOURCE!** Nine floors of electronic parts and equipment (one of the largest inventories in the U.S.A.!) help speed up your development and production schedules.

This is your invitation to enjoy **HARRISON** hospitality! Cocktails and buffet served noon to closing. Souvenirs. Bring your lady! Be sure to come—we'll be looking for you.

**IRE'ers . . . make your convention trip complete by visiting one of the country's largest and oldest electronics distributors. Make HARRISON'S your New York headquarters. Convenient to all subway and bus lines -- from Grand Central, take Lexington Ave. Express downtown (3 stops) to Fulton, walk 2 short blocks west. Or, grab a cab!**

**HARRISON HAS IT!**

**HARRISON RADIO CORPORATION**  
**225 GREENWICH ST. (10 West Broadway)**  
**NEW YORK 7, N.Y. • BArcly 7-7777**



when better **SYNCHROS**  
are required  
**SPECIFY**

*Telesyn*

**FORD**

WRITE FOR NEW  
TELESYN BROCHURE

- Proved Precision Accuracy
- Meet Government Specifications
- Corrosion Resistance
- Fungus Resistance
- Available in wide selection of sizes

**FORD INSTRUMENT COMPANY**

Division of the Sperry Corporation  
31-10 Thomson Avenue  
Long Island City 1, N. Y.

**FIRST WILDER**  
IN QUALITY

**ADJUSTABLE  
SOLDERING IRON  
HOLDER**

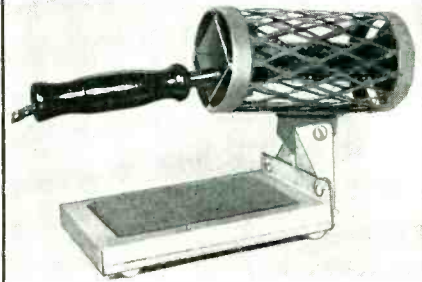

FOR *Safety*  
AND *Speed*

**IN SOLDERING**

AVAILABLE WITH WIPING PAD AS  
SHOWN ABOVE OR WITH BRACKET  
FOR BENCH AND SHELF MOUNTING  
FOR COMPLETE INFORMATION WRITE  
**WILDER MFG. CO., INC.**  
411 LEXINGTON AVENUE  
BROOKLYN 16, N. Y.

# ZOPHAR

WAXES  
COMPOUNDS

Anti-Corona high heat-resistant compounds for Fly Back Transformers.

Waxes and compounds from 100° F to 285° F Melting Points for electrical, radio, television, and electronic components of all types.

Pioneers in fungus-resistant waxes.

Our efficient and experienced laboratory staff is at your service.

Engineers visiting the IRE show are invited to call Mr. Mayer or Mr. Saunders at SOuth 8-0907 if they wish to discuss their wax problems either at our plant or other convenient place.



**ZOPHAR MILLS, INC.**  
112-130 26th Street,  
Brooklyn 32, N. Y.

## EISLER Television Tube MACHINERY

- ECONOMICAL
- MODERN DESIGN
- PRODUCTION ENHANCING

TV Sealing Machine

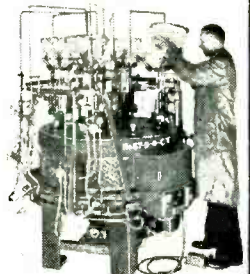

Machines for Manufacturing Incandescent Lamps, Radio and Electronic Tubes

RESISTANCE WELDERS  
1/4 to 300 KVA

From 5" to huge 24" Television Tube



EISLER'S Electronic Equipment is especially Designed and Built to your exact requirements.

EISLER TRANSFORMERS  
STANDARD • SPECIAL

WE INVITE YOUR INQUIRIES Sizes From 1/4 to 500 KVA



**EISLER ENGINEERING CO., Inc.**  
751 So. 13th St. Newark 3, N. J.

cations are its fast response, independence of calibration, simplicity of operation and versatility.

**High-Potential Testers.** Associated Research, Inc., 3758 West Belmont Ave., Chicago 18, Ill. Bulletin 4A deals with the Hypot Juniors, a line designed for high-potential testing for leakage, breakdown or shorts in a single instrument. Illustrations, complete description, details on simple operation and technical specifications are included.

**Hook-Up Wire.** Rome Cable Corp., 330 Ridge St., Rome, N. Y. Bulletin TR-901 gives complete information on a new high-temperature, space-saving radio and tv hook-up wire with an 8-mil wall. The wire described is insulated with Synthinol 901, a thermoplastic compound, plus nylon sheath or lacquered braid and is fully approved by Underwriters' Laboratories, Inc. for continuous operation at 90 C above or below the chassis in approved applications. Diameters available for the wire discussed range from 0.051 in. to 0.1 in.

**Servo Unit.** Avion Instrument Corp., 121 East 24th St., New York 10, N. Y. A single-sheet bulletin treats of the type 60-A servo unit designed for use in computer circuitry and for remote positioning devices requiring low torque. Photographs, description of operation, typical specifications and dimensional diagrams are included.

**Bimetal Strip Thermostats.** Stevens Mfg. Co., Inc., 69 South Walnut St., Mansfield, Ohio. Bulletin F-2008 describes the type C bimetal strip thermostats for use in communications equipment, electronic and avionic devices, and other types of electrical apparatus. It is illustrated with photographs of standard and hermetically sealed models, dimensions, a schematic diagram showing operating principle and a typical thermostat response curve.

**VHF Crystal Probes.** United Technical Laboratories, Morristown,

# Edin instruments



## OSCILLOGRAPH GALVANOMETER

No's. 8001, 8002, 8003 and 8004 ink-writing galvanometers have sensitivities from 3.5 to 40 volts per cm., resonant frequencies from 15 to 120 cps., resistances from 1000 to 2000 ohms, frequency response up to 350 cps., and a single-jewel pivot construction. Units are designed for multiple operation up to 10 channels in a total width of 12 inches.



## DIRECT-COUPLED AMPLIFIER

No. 8100 direct coupled amplifier has a voltage amplification of 13,000 with a maximum output of 70 volts. Frequency response from d.c. to 10,000 cps. is flat within 10%. Input impedance is 2 megohms; output impedance is 150 ohms. Input may range from 0.1 mv. to 100 volts. Stability is better than 0.1 mv. per thirty minutes, or 0.5 mv. per day. Attenuator is stepped for factors from 1 to 1000.



## OSCILLOGRAPHS

Recorders can be supplied with 1, 3 or 9 chart speeds ranging from 0.1 mm./sec. to 250 mm./sec. See specifications of OSCILLOGRAPH GALVANOMETER for frequency range.

## OSCILLOGRAPH AMPLIFIER

No. 8121 special amplifier has a time constant of 1 second, an exponential response to a square wave at high gain, input impedance of 1 megohm, and input from 0.1 mv. to 1000 volts. At low gain, No. 8121 becomes a DC amplifier with a voltage gain of 100 and an input of 10 mv./mm.

## HIGH-GAIN AMPLIFIER

No. 8130 amplifier has a voltage gain of 1,000,000 and includes a built-in pre-amplifier. Frequency response is from 1 to 200 cps. Input may range from 10 microvolts to 100 millivolts. This amplifier is particularly suited for Biological studies.

Many other types of recording and amplifier circuits are available and special equipment can be assembled to meet particular specifications.

EDIN COMPANY, INC.  
207 Main Street  
Worcester 8, Mass.

Please send complete information on:

- |   |   |
|---|---|
| <input type="checkbox"/> RECORDERS          | <input type="checkbox"/> No. 8100 AMPLIFIER |
| <input type="checkbox"/> NO. 8121 AMPLIFIER | <input type="checkbox"/> No. 8130 AMPLIFIER |
| <input type="checkbox"/> GALVANOMETERS      |   |

SPECIAL (Enclose details)

.....  
(NAME)

.....  
(NO.)

.....  
(STREET)

.....  
(CITY)

.....  
(STATE)

.....  
COMPANY

.....  
POSITION



# ANY SIZE

# Spiral Wound PAPER TUBES

from .450" to 25" I.P.  
from 1/2" to 30" Long

It pays to check your requirements with PARAMOUNT... because you benefit from PARAMOUNT'S coil-proved design and construction—vast range of stock arbors—wide experience in engineering special tubes! Hi-Dielectric. Hi-Strength. Kraft, Fish Paper, Red Rope, or any combination wound on automatic machines. Tolerances  $\pm .002"$ .

**ALSO:** Shellac-Bound Kraft paper tubing. Heated shellac forms an adhesive bond between the laminations. Absolutely moisture resistant.

SQUARE  
RECTANGULAR  
TRIANGULAR  
HALF-ROUND  
ROUND

WRITE ON COMPANY  
LETTERHEAD FOR  
STOCK ARBOR LIST  
OF OVER 1000 SIZES

## Paramount PAPER TUBE CORP.

616 Lafayette St., Fort Wayne, Ind.

Mfrs. of Paper Tubing for the Electrical Industry

## TOROIDAL COILS?

Your needs are our business. We specialize in uncased toroids wound to your specifications on the new high "Q" powdered molybdenum permalloy core material. Our prices are low, our quality unsurpassed. Send us your requirements today for prompt attention.

### TOROCOIL COMPANY

5387 Northland

St. Louis 12, Missouri



### MODEL 410-A ULTRA-LOW FREQUENCY OSCILLATOR

with frequency range of  
**0.02-20,000 cps**

#### FEATURING:

1. BOTH SINE AND SQUARE WAVE.
2. COMPLETELY ELECTRONIC OPERATION.
3. EXCELLENT AMPLITUDE CONSTANCY.
4. LOW DRIFT AND DISTORTION.

**DESCRIPTION:** This oscillator, Model 410-A, covers the sub-audio and the entire audio range. It provides both sine and square wave at any frequency range between 0.02 and 20,000 cps.

Precisely engineered and constructed, the Model 410-A is ideal for medical research, geophysical and seismological instruments, and design and development of servo-mechanisms and vibration controls.



**KROHN-HITE INSTRUMENT CO.**  
580 MASSACHUSETTS AVE., CAMBRIDGE 39, MASS., U.S.A.

#### SPECIFICATIONS:

1. **FREQUENCY RANGE:** 0.02 to 20,000 cps, continuously variable in six decade bands.
2. **SINE WAVE AMPLITUDE:** Varies less than  $\pm 0.25$  db (3%) over the entire frequency range.
3. **DISTORTION & HUM:** Less than 0.25% over the entire frequency range.



... highest known  
**Recording Efficiency**  
for Instrumentation Applications

Ampex Magnetic Tape Recorders offer the only proved means of making electrically reproducible recordings up to 40,000 cps! Such critical recording permits detailed study of particular phenomena from tape loops, or other automatic data reducing systems. Up to 14 channels of data recorded simultaneously on separate tracks where required. Special systems record down to 0 cycles with no phase shift or wave form distortion. Write for analysis of your specific problem.



Ampex Magnetic Tape Recorders are available in console, rack or portable types.

#### UNLIMITED USES INCLUDE:

- Recording-Broadcasting
- Aerophysical Research
- Industrial Recording
- Multi-Channel Recording
- Laboratory Research
- Portable Half-Track Recording
- Telemetry

STANDARD OF THE GREAT RADIO SHOWS  
**AMPEX**  
MAGNETIC TAPE RECORDERS

AX 75

AMPEX ELECTRIC CORP.  
San Carlos, Calif.

For  
**HIGHEST ELECTRICAL  
& MECHANICAL EFFICIENCY!**  
New  
**JONES**

### SERIES 2400 PLUGS & SOCKETS

• Improved Socket Contacts—4 individual flexing surfaces. Positive contact over practically their entire length.

• Cadmium plated Plug and Socket, Contacts mounted in recessed pockets, greatly increasing leakage distance, INCREASING VOLTAGE RATING.

• Interchangeable with 400 Series.

Send for complete Catalog No. 17. Plugs, Sockets, Terminal Strips.



P-2406-CCT



S-2406-5B



**HOWARD B. JONES DIVISION**  
CINCH MANUFACTURING CORPORATION  
CHICAGO 24, ILLINOIS  
SUBSIDIARY OF UNITED-CARR FASTENER CORP.

N. J. A four-page folder illustrates and describes the Klipzon types V and C vhf germanium crystal probes designed to add versatility and speed to laboratory and service equipment. The probes discussed feature unique self-holding test points and complete shielding, and the price of each is \$6.95.

**Substitution Tubes.** Sylvania Electric Products Inc., Emporium, Pa., has announced a new 40-page tube substitution manual for quick reference for substitute types of radio and tv tubes. The manual is arranged in nine sections providing informative text and charts on general tube classification; circuit modifications in which additional resistors are needed; substitute battery-type tubes; substitute 150-ma types; substitute 300-ma types; substitute transformer and auto tube types; substitute tv receiving tubes; substitute tv picture tube types; and frequently needed changeover diagrams.

**TV Products.** Brach Mfg. Corp., 200 Central Ave., Newark, N. J., is distributing a catalog describing all its new and current products. It is divided into two sections: one describing tv antennas and accessories, and the other, the components of the Mul-Tel system. Actual pictures are used to describe the individual units, except for minor accessories where drawings are employed.

**Electron Tubes.** Radio Corp. of America, Harrison, N. J. Designed for users in industrial, broadcast, experimental, and similar fields, the new CRPS-102-A booklet provides detailed technical data on more than 150 electron tubes. Technical information, arranged in tabular form, includes descriptions, rating, operating conditions, dimensions, base and envelope connection diagrams and applications of a line of phototubes, cathode-ray and special tubes.

**Replacement Control Chart.** Centralab Division of Globe-Union, Inc., 900 E. Keefe Ave., Milwaukee 1, Wisconsin, has available a new,

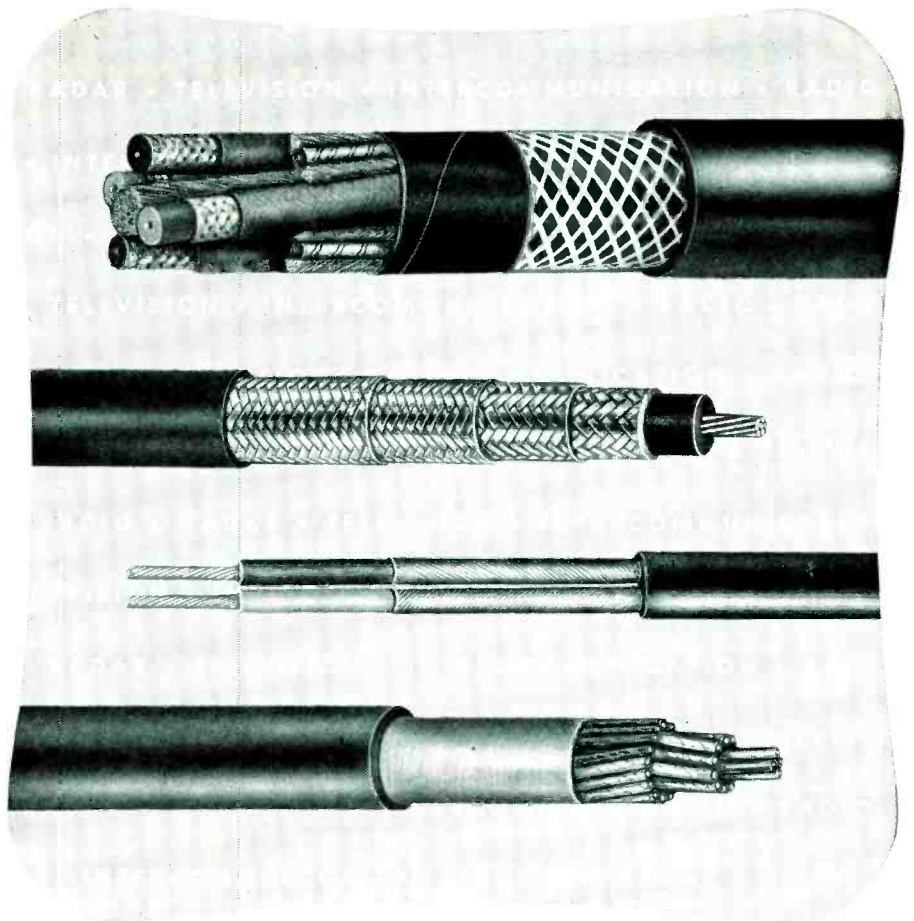

## For special cables go to specialists

# Rome Cable

Electronic wiring components must conform to exacting specifications for quality performance. This is particularly true in high frequency applications where sensitive and dependable operation is so important. Leading manufacturers turn to Rome Cable for their electronic needs . . . because they know their specification requirements will be met exactly.

Rome Cable has the facilities, experience and engineering "know-how" to produce complicated special cables of the highest quality, utilizing both rubber and thermoplastics, typical examples of which are shown above. This, coupled with a complete line of Underwriters' Approved standard radio and television hook-up wires (including military types), makes Rome your best source of supply. The coupon below will bring you descriptive literature. Mail it today.

**IT COSTS LESS TO BUY THE BEST**

ROME CABLE CORPORATION

Dept. E-3 • Rome, N. Y.

Please send me information on Electronic Wiring.

Name.....

Company.....

Address.....

City..... State.....

**ROME CABLE CORPORATION**  
ROME, NEW YORK





# High Sensitivity . . . Logarithmic AC VOLTMETER

## 50 MICROVOLTS TO 500 VOLTS

MODEL 47 VOLTMETER

**SELF-CONTAINED  
ALL AC OPERATED UNIT**  
An extremely sensitive amplifier type instrument that serves simultaneously as a voltmeter and high gain amplifier.

- Accuracy  $\pm 2\%$  from 15 cycles to 30 kc.
- Input impedance 1 meg-ohm plus 15 uuf. shunt capacity.
- Amplifier Gain 25000

Also MODEL 45  
WIDE BAND  
VOLTMETER  
.0005 to 500 Volts!  
5 Cycles 1600 kc.

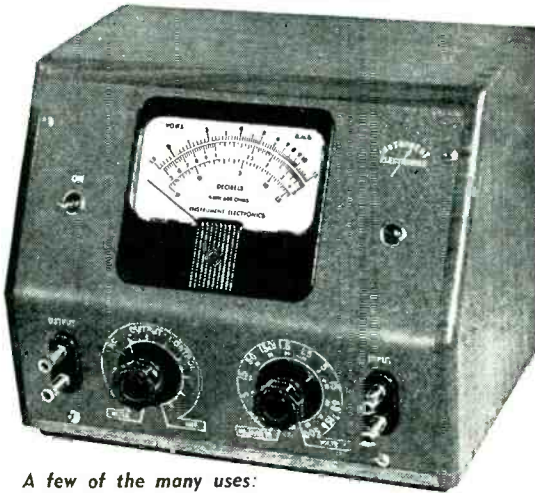

A few of the many uses:

- Output indicator for microphones of all types.
- Low level phonograph pickups.
- Acceleration and other vibration measuring pickups.
- Sound level measurements.
- Gain and frequency measurements for all types of audio equipment.
- Densitometric measurements in photography and film production.
- Light flux measurements in conjunction with photo cells.

Write for Complete Information

**Instrument Electronics Corp.** 104 West Jefferson Street  
FALLS CHURCH, VIRGINIA

# SYNTRON SELENIUM RECTIFIERS

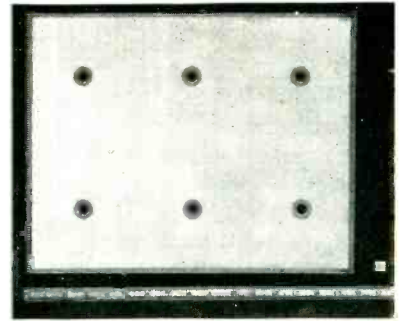

1" sq. to 12" x 16" cells—in stacks, or single cells for customer assembly.

Made by a new process to a uniform, high quality for continuous, heavy-duty service.

Write for literature

**SYNTRON CO.**  
241 Lexington Homer City, Pa.

# MAGNETIC AMPLIFIERS AND CONTROL SYSTEMS FOR LOW LEVEL AND POWER APPLICATIONS

Magnetic Components for: Servo Amplifiers • Control Systems • Voltage and Frequency Regulators • Computer Circuits • Thermocouple and Strain Gage Converter Amplifiers • Trigger Circuits • D.C. Amplifiers

A standard line of magnetic power stages designed to drive most high performance servo motors in use today.

Write for our bulletin No. 1000-1-H49.

**MAGNETICS, INC.** 135 Bloomfield Avenue  
Bloomfield, N. J.

# CHECK WITH LOS GATOS for your power-tube needs

Call on Lewis & Kaufman with your full tube-complement problems. Both JAN-IA and commercial types, including tantalum- and zirconium-molybdenum-anode tubes in long-lived Los Gatos Brand—backed by pioneers in the field.

**LEWIS & KAUFMAN, INC.**  
LOS GATOS CALIFORNIA



4E27

The  
**FISHER-PIERCE**

# PHOTOELECTRIC TOWER LIGHTING CONTROL

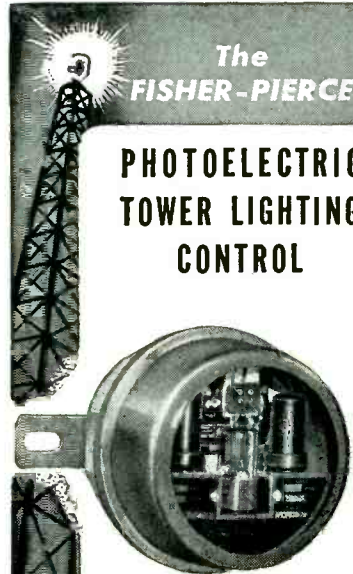

Turn-on 35 ft.-candles—off at 55 ft.-candles—independent of time of day or weather conditions.

Low first cost—negligible maintenance.

3000 watts contact capacity.

Over 20,000 in use for tower and street lighting.

Complete details available—ask for Bulletin 63305.

The **FISHER-PIERCE**  
COMPANY, Inc.

42 Ceylon St., Boston 21, Mass.

ready-reference aid to quick servicing in its Adashaft chart showing the varied shaft and switch cover combinations used for replacement controls. The chart enables the service engineer to select the type and size shaft and switch cover needed for the individual replacement job.

**Oscilloscope Camera.** Fairchild Camera and Instrument Corp., 88-06 Van Wyck Blvd., Jamaica 1, N. Y., has issued a 20-page booklet containing the transcript of an address on the model F-284 Polaroid-Land camera for oscilloscope recording. The booklet is fully illustrated, gives a complete description of the unit, and contains a section of pertinent questions and answers.

**Capacitor Catalog.** Illinois Condenser Co., 1616 North Throop St., Chicago, Ill. A 12-page catalog describes and illustrates a line of six types of capacitors. Data shown for each are the part numbers, with their individual capacitance in  $\mu\text{mf}$ , d-c working voltage, diameter, length and list price.

**Control Relays & Switches.** Automatic Electric Co., 1033 W. Van Buren St., Chicago 7, Ill., has issued an 88-page catalog and technical guide covering its line of relays and switches for industrial control. Shown and described are telephone-type relays, stepping switches and mounting facilities. Featured are class B general-purpose relays and two new high-speed rotary stepping switches—types 44 and 45. Complete technical data are included as a guide for selection of components to meet any desired application, as well as data on hermetic sealing for all relay types.

**Phase Sequence Indicator.** Associated Research Inc., 3758 West Belmont Ave., Chicago 18, Ill. Bulletin 7A covers the model 40 phase sequence indicator for 115, 220 or 440-volt circuits. Illustration, mode of operation, chief features and price are given. The unit described, which weighs less than a pound, measures only 3 in. x 5½ in. x 2 in. and features instant reading.

For **INDUSTRY • RESEARCH • PRODUCTION • SERVICE**

**You can get it—  
at MILO!**

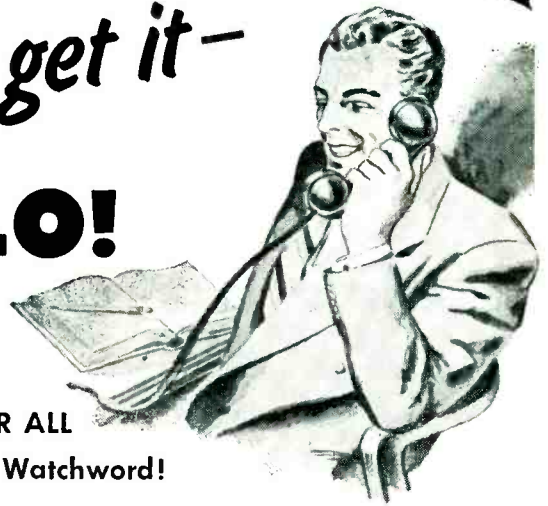

**FAIR DISTRIBUTION FOR ALL**

**is the MILO Watchword!**

Yes, in these days of war and re-armament there are plenty of shortages in electronic components and equipment. But **Milo comes through for you!** And here's why:

Because Milo believes in **just and equitable distribution to all** its customers, whether old or new. This is the fair-play creed of service

and cooperation that built Milo—and Milo sticks to it, scarcities or no.

Because Milo's great warehouse holds **complete stocks of all the best lines.** Just look at this partial list of the more than 150 first-rate manufacturers whose products are available now from Milo:

ADVANCE ELECTRIC  
AEROVOX  
ALPHA WIRE  
AMERICAN TELEVISION & RADIO  
BELDEN • BLILEY  
DAVID BOGEN  
BUD • BURGESS  
BUSSMANN  
CLAROSTAT  
CONDENSER PRODUCTS  
CORNELL-DUBILIER  
CONTINENTAL CARBON  
DEJUR-AMSCO  
DIALCO • DRAKE  
EITEL-McCULLOUGH

ERIE  
GENERAL CEMENT  
GENERAL ELECTRIC  
GUARDIAN ELECTRIC  
HAMMARLUND  
HICKOK • HYTRON  
INSULINE • IRC  
E. F. JOHNSON  
KESTER  
KINGS ELECTRONICS  
LITTELFUSE  
JAMES MILLEN  
NATIONAL COMPANY  
OHMITE  
PAR-METAL  
POTTER & BROMFIELD

PRECISION APPARATUS  
PREMAX  
SANGAMO  
SHALLCROSS  
SHURE BROS.  
SIMPSON ELECTRIC  
SOLA ELECTRIC  
SPRAGUE  
STANDARD TRANSFORMER  
SUPERIOR ELECTRIC  
SYLVANIA • TUNG-SOL  
TRIPLETT  
UNGAR ELECTRIC  
WARD LEONARD  
WESTON



Write for  
your  
**MILO**  
Catalog

Milo's newest catalog, jam-packed with 1053 pages of descriptions, specifications, illustrations and prices, is the key to the latest electronics products you want. Write for it today—on your company letterhead, please, stating your position, since it is limited to responsible officials only.

**MILO doesn't just talk cooperation.  
MILO GIVES YOU COOPERATION!**

**MILO**

PHONE

**BEekman 3-2980**

**Radio & Electronics Corp.**

200 Greenwich Street, New York 7, N. Y.

Cable Address: MILOELECTRO

The ONE source for ALL your electronic needs



# The new S.S. WHITE 80X HIGH VOLTAGE RESISTOR

(1/2 Actual Size)

4 watts • 100 to 100,000 megohms

Developed for use as potential dividers in high voltage electrostatic generators, S.S. White 80X Resistors have many characteristics—particularly negative temperature and voltage coefficients—which make them suitable for other high voltage applications. They are constructed of a mixture of conducting material and

binder made by a process which assures adequate mechanical strength and durability. This material is non-hygroscopic and, therefore, moisture - resistant. The resistors are also coated with General Electric Dri-film which further protects them against humidity and also stabilizes the resistors.

## WRITE FOR BULLETIN 4906

It gives complete information on S.S. White resistors. A free copy and price list will be sent on request.



**THE S.S. White INDUSTRIAL DIVISION**  
DENTAL MFG. CO.



Dept. R, 10 East 40th St.  
NEW YORK 16, N. Y.

WHEN CONSIDERING  
COILS...  
CALL DANO



Your exact coil made to perform perfectly and sold to you at favorable prices is Dano's policy. Consider this the next time you need coils.

Also, Transformers Made To Order

- Form Wound
- Paper Section
- Acetate Bobbin
- Molded Coils
- Bakelite Bobbin
- Cotton Interweave
- Coils for High Temperature Application



**THE DANO ELECTRIC CO.**  
MAIN ST., WINSTED, CONN.

Eliminate Die Costs!  
**SAVE MONEY** on  
**MIL-T-27 CANS**



Heldor

Now you can save die and tooling costs when you get MIL-T-27 cans from Heldor! All standard sizes of these cans are available and supplied with or without brackets, weld studs, centrifugal hot tinned, blind inserts, compression-type hermetic bushings on 3/8", 1/2", 5/8", 3/4" centers, and stamped ratings. Custom sizes can also be supplied.

Our other services include: special tube bending, specialized screw machine products, and complete hermetic seal assemblies. Write for specifications and price list.

**HELDOR METAL PRODUCTS CORP.**

NOTE NEW ADDRESS: 85 Academy St., Belleville 9, N. J.

VISIT BOOTH 5-3 AT THE I. R. E. SHOW

# ALLISON RADAR

FOR

## MULTI-ENGINED AIRCRAFT

Military  
Airline

Executive

Models E ES EB

58-65 lbs. Overall Weight

1. Long range. 80-150 miles.
2. Exclusive scanning method.
3. Compact. Sturdy.
4. Easy to operate. Pilot control.
5. Simplicity of maintenance.
6. Gyro-stabilized.
7. JAN components.
8. RACON beacons.

**ALLISON**  
**RADAR CORPORATION**  
11 W. 42 St., N.Y. 18 Penn 6-5811-12

## Wizardry in WIRE FORMS

Small diameter wire formed  
in any shape you need!

### STRAIGHTENING & CUTTING

Perfect straight lengths to 12 ft.  
.0015 to .125 diameter

### WIRE FORMS

.0015 to .080 diameter

### SMALL METAL STAMPINGS

.0025 to .035 thickness  
.062 to 3 inches wide

Here's the "know how" and mass production capacity to turn out any quantity of small wire forms, parts and stampings in ferrous and non-ferrous metals and alloys—accurately, economically, speedily!

★

Specializing in Production of Parts  
for Electronic and Cathode Ray Tubes

Write for Illustrated Folder  
Send Blueprints or Samples for Estimate  
**ART WIRE & STAMPING CO.**  
227 HIGH STREET, NEWARK 2, N. J.

## NEWS OF THE INDUSTRY

(continued from page 150)

I. W. Hammer and P. H. Haas.  
Spark-Over of Air at Radio Frequencies, by W. Caywood, Jr.  
New Limits for Low-Level RF Energy Measurements, by W. K. Volkers.  
Computers II—Analog Computers  
A Sampling Analog Computer, by J. Broomall and L. Riebman.  
A Time-Division Multiplier for a General Purpose Electronic Differential Analyzer, by R. V. Baum and C. D. Morrill.  
A High-Speed Product Integrator, by A. B. Macnee.  
Plug-In Units for Digital Computation, by G. Glineski and S. Lazecki.  
A Five-Digit Parallel Coder Tube, by J. V. Harrington, K. N. Wulfsberg and G. R. Spencer.

### Circuits III—General

A Linear Operational Calculus of Empirical Functions, by R. G. Piety.  
Pulse Transformer Considered as a Wide-Band Network, by E. G. Rudenburg.  
Single-Tapped Coil Delay Line, by S. G. Lutz.  
Nickel Acoustic Delay Line, by T. F. Rogers and S. J. Johnson.  
Amplifier Synthesis on Equal-Ripple Basis, by D. L. Trautman and J. A. Aseltine.

### Broadcast and TV Receivers

90-Degree Deflection Yoke Design—The Design of Wide-Angle Deflection Yokes, by H. Thomas.  
Semi-Automatic Fabrication of Audio and Video Equipment, by W. H. Hannahs, R. Bahr, and J. Caffiaux.  
UHF Converter, by B. F. Tyson.  
Power Supplies for Television Receivers, by A. M. Levine and S. Moskowitz.  
Radio Receiver Subminiaturization Techniques, by G. Shapiro.  
Microwaves III—Antennas and Artificial Dielectrics A

The Study of Artificial Dielectrics of the Obstacle Type, by C. Susskind.  
Isotropic Artificial Dielectric, by R. W. Corkum.

A Virtual Source in Microwave Optics, by K. S. Kelleher.

Experimental Prototype of the Rinehart-Luneberg Lens, by E. C. Fine.

Propagation of Microwaves Between Parallel Conducting Surfaces, by K. S. Kuns.

Phase Shift of Microwaves in Passage Through Parallel-Plate Arrays, by D. J. Epstein.

### Radar and Navigation

On the Measurement of the Radar Echoing Areas of Conducting Bodies, by J. R. Mentzer.

Polarization Properties of Target Reflections, by E. M. Kennaugh.

The Use of Circular Polarization as a Means of Reducing Radar Precipitation Return, by W. D. White.

An ICW System for Distance Measurements, by J. Lyman, G. Litchford and C. Grunsky.

Effects of Vertical Radiation Pattern on Omirange Beacon Characteristics, by S. Pickles.

### Thursday A. M., March 22 Nuclear Science

A Delayed Coincidence Scintillation Spectrometer, by F. K. McGowan.

Timing Unit and Pulse Deflector Generator for 145-Inch Synchrocyclotron, by E. M. Williams, C. H. Grace and L. W. Johnson.

Design and Construction of a Billion-Volt Linear Electron Accelerator, by M. Chodorow, E. L. Ginzton, J. Jasberg, R. Kyhl, R. Neal and P. Pearson.

Precise Measurement and Regulation of Magnetic Fields with RF Techniques Using Nuclear Resonance, by H. A. Thomas.

A High-Precision Magnetic Field Measuring Instrument, by E. C. Levinthal.

### Television II

Parallel Operation of Vacuum Tubes at UHF to Obtain High Transmitter Power, by W. H. Sayer, Jr., and E. Mehrbach.

An Ultra-Portable Television Pickup Equipment, by L. E. Flory, W. S. Pike and J. E. Dilley.

The Technique of Dot-Arresting for Television Transmission Using Dot Interlace, by K. Schlesinger.

A Sweep Method for Measuring the Transmission Amplitude Characteristic of a Television Transmitter, by J. Ruston.

### Circuits IV—Amplifiers

RF Amplifier Design for Low Noise Figure, by R. Guenther.

HF Amplifiers with Direct Coupling, by D. R. Crosby and K. F. Umpleby.

Distributed Amplification: Additional

## Equipment for Strain Recording

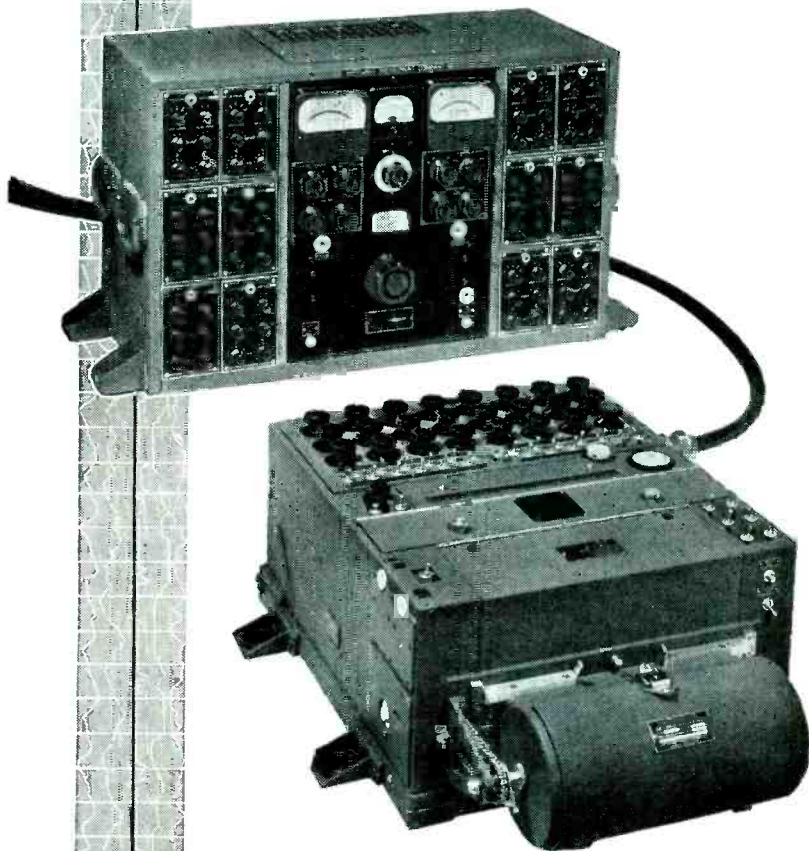

Illustrated is a complete 12-channel portable laboratory for precision strain determination from static strain to a frequency of 5000 cycles per second, using resistance gages that are attached by cement to the points of strain.

In the field or in the laboratory... on a high-speed locomotive or in the air... HATHAWAY strain recording equipment is ideal for the recording of STATIC AND DYNAMIC STRAIN in structural members and machines in operation.

Complete with all necessary balancing controls and monitoring instruments, precision calibrating device, power supply equipment and oscillator, and type S8-B Oscillograph.

**TYPE MRC-15** 12-element Strain Gage Control Unit. Fully described in Technical Bulletin SP 195 G

**TYPE S8-B** 12- to 48-element Oscillograph. Fully described in Technical Bulletin SP 165 G

*Hathaway*   
**INSTRUMENT COMPANY**  
1315 SO. CLARKSON STREET • DENVER 10, COLORADO



# Standard RADIO INTERFERENCE and FIELD INTENSITY Measuring Equipment

Complete Frequency Coverage - 14kc to 1000 mc!



**VLF!**

**NM - 10A**

14kc to 250kc

Commercial Equivalent of AN/URM-6.

Very low frequencies.

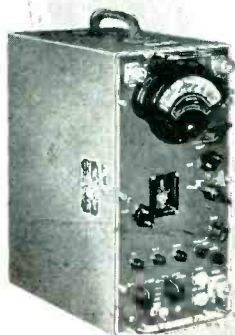

**HF!**

**NM - 20A** 150kc to 25mc

Commercial Equivalent of AN/PRM-1. Self-contained batteries. A.C. supply optional. Includes standard broadcast band, radio range, WWV, and communications frequencies.

**VHF!**

**NMA - 5**

15mc to 400mc

Commercial Equivalent of TS-587/U.

Frequency range includes FM and TV Bands.



**UHF!**

375mc to 1000mc **NM - 50A**

Commercial Equivalent of AN/URM-17.

Frequency range includes Citizens Band and UHF color TV Band.



These instruments comply with test equipment requirements of such radio interference specifications as JAN-I-225, ASA C63.2, 16E4(SHIPS), AN-I-24a, AN-I-42, AN-I-27a, AN-I-40 and others.

**STODDART AIRCRAFT RADIO CO.**

6644-A SANTA MONICA BLVD., HOLLYWOOD 38, CALIFORNIA

Hillside 9294

Considerations, by J. Weber.  
Distributed Amplification for Pulses, by R. B. White.  
Cathode-Coupled Clipper Response, by P. F. Ordnung and H. L. Krauss.

#### Audio

A Single-Ended Push-Pull Audio Amplifier, by A. Peterson and D. B. Sinclair.

The Application of Damping to Phonograph Reproducer Arms, by W. S. Bachman.

Transient Testing of Loudspeakers, by O. K. Mawardi.

A Practical Speech-Silencer for Radio Receivers, by R. C. Jones.

Microwaves IV—Antennas and Artificial Dielectrics B

The Half-Space as a Spherical Transmission Line, by L. Felson and N. Marcuvitz.

The Calculation of Progressive-Phase-Shaped-Beam Antennas, by A. S. Dunbar.

Physical Limitations on Minimum Size Lobes in Broadside Arrays, by J. Ruze.

The Behavior of Microwaves in Focal Regions, by F. J. Zucker.

A Microwave Schmidt System, by H. N. Chait.

Symposium: Telemetry Systems

Thursday P. M., March 22

Symposium: Nuclear Reactors

Television III—Receivers

Synchroflexion: A Horizontal Deflection System Possessing Inherent Noise Immunity, by K. R. Wendt and W. K. Squires.

Internal Television Receiver Interference, by B. Amos and W. Heiser.

An RF Amplifier for the UHF Television Bands, by B. F. Tyson and J. G. Wiessman.

Television Line Selector with Automatic Identifier, by J. Fisher.

Development of a High-Stability UHF Television Tuner, by M. W. Slate, J. P. Van Dwyne and E. G. Mannerberg.

Circuits V—Oscillators

Oscillator Frequency Indeterminacy, by L. Riehm.

Simultaneous Oscillations in Oscillators, by H. Schaffner.

Amplitude Stabilization of Oscillators by Nonlinear Networks, by L. Rosenthal.

Stability of Oscillations in a Nonlinear System, by N. R. Scott.

Tuned Coupled Circuit for Oscillator Application, by R. A. Martin and R. D. Teasdale.

Symposium: Loudspeakers

Microwaves V—Generators and Amplifiers

Low-Distortion Frequency-Modulation Modulators, by A. R. Vallarino.

1,700- to 2,400-Megacycle Triode Amplifier, by E. M. Ostlund and H. G. Miller.

A K-Band Amplifier Klystron, by W. G. Abraham and J. W. Clark.

Mode Interactions in Magnetron Oscillators, by R. Moats.

Guiding Principles in the Production of Submillimeter Waves, by H. M. Von Foerster and H. Schaffner.

Symposium: Simulation As An Aid to Design of Remote Control Systems

## Eta Kappa Nu Awards

THE OUTSTANDING young electrical engineers of the U. S. were recognized and presented awards by the Eta Kappa Nu Association in New York during the week of the Winter General Meeting of the AIEE. To qualify for the award a candidate must be not older than 35 years nor be out of college for more than 10 years by May 1 of the year for which he is cited. After qualifying on these two counts the candidate is judged on the basis of accomplishment in professional, social and cultural fields.

This year's winner was Donald P. Campbell of MIT. Recipients of honorable mention certificates were



# NEW CORONA SEALED FLY BACK TRANSFORMER



- Core and Coil encased in molded self-extinguishing plastic
- No rejects from careless handling
- No supersonic singing
- No corona discharge
- No fire hazard
- Moisture proof

Used in high efficiency 66°-70° circuit provides full deflection with up to 14KV anode potential

SEE IT IN BOOTH 231

See, too, the  
**NEW SQUARE ROOT**  
complete line of  
**CONDENSERS**  
Glass . . . Paper . . . Ceramic

Electronically Rotated  
**ANTENNAS**  
Built-in and Roof-Top

Brand New plant and equipment  
Old fashioned, proved Know-How and experience available to assist you in your  
**GOVERNMENT CONTRACTS**

- Filter networks
- Machine laced harnesses
- Servo Amplifiers and Systems
- Teroidal Coils

See us at the IRE Show booth 231, or write, wire or phone

**SQUARE  
MANUFACTURING CORP.**  
**V  
ROOT**  
391 SAW MILL RIVER ROAD  
YONKERS, NEW YORK  
Yonkers 8-1213

# University LOUDSPEAKERS

A TRADITION FOR  
Quality and Dependability

... designed by  
**PROGRESSIVE  
ENGINEERING!**

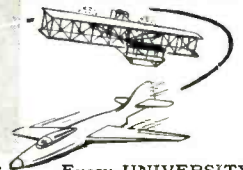

These speakers — the first to be Underwriters' Laboratories approved for Class 1 and 2 locations—permit industries previously denied the advantages of sound, paging, and intercom to proceed with 100% safe installations in locations where flammable liquids, gases, dust or other combustibles are present. Dependable in performance, easy to install, Models 7101 and 7102 feature a built-in line matching transformer, 180° swivel mounting bracket, capped 1/2" conduit entrance and a wide coverage 55° dispersion angle. Frequency response from 200 to 10,000 cps is ideal for both voice and music. Construction is weather and corrosion proof throughout.

See us at the I.R.E.  
ST-37 BOOTH 323

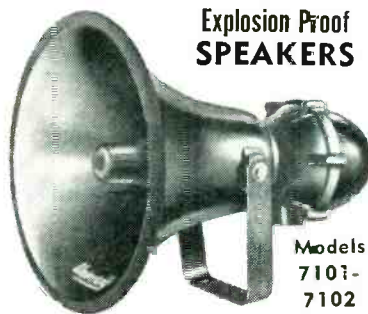

**Explosion Proof  
SPEAKERS**

Models  
7101-  
7102

Every UNIVERSITY product is built to traditional standards of quality that have earned a world-wide reputation for absolute dependability. Highest quality materials, skillfully fabricated, result in unsurpassed performance and extra reliability. "Progressive Engineering" assures the latest design improvements in every piece of UNIVERSITY equipment.

Ask for your  
free copy of the  
**TECHNOLOG**

Handy technical catalog, published for engineers, installers, service men. Request yours today — write Desk 31



**UNIVERSITY  
LOUDSPEAKERS • INC**  
80 SO. KENSICO AVE., WHITE PLAINS, N. Y.



## THREE DECADES OF RADIO-TELEVISION "KNOW-HOW"

an **insuline** cabinet or chassis for every need

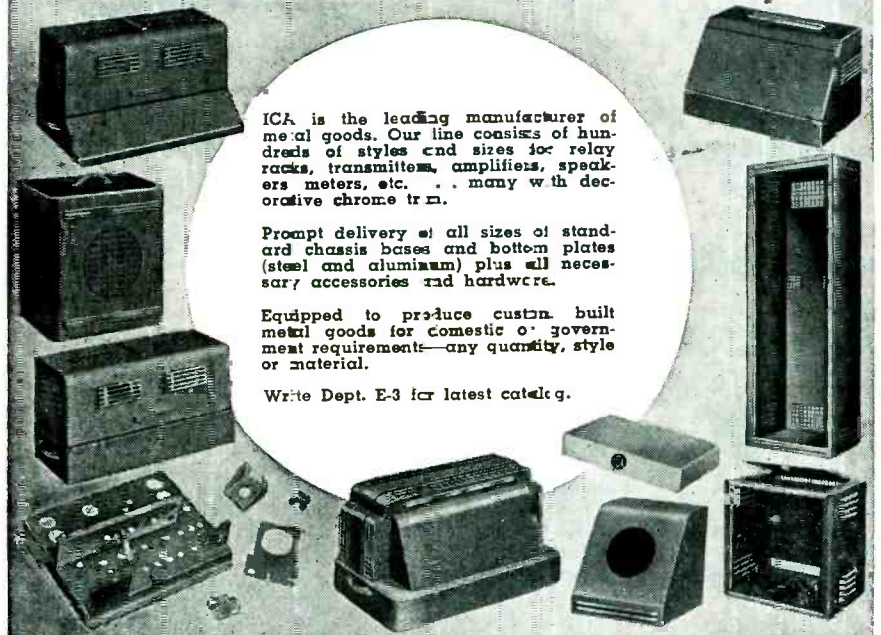

ICA is the leading manufacturer of metal goods. Our line consists of hundreds of styles and sizes for relay racks, transmitters, amplifiers, speakers, meters, etc. . . many with decorative chrome trim.

Prompt delivery of all sizes of standard chassis bases and bottom plates (steel and aluminum) plus all necessary accessories and hardware.

Equipped to produce custom built metal goods for domestic or government requirements—any quantity, style or material.

Write Dept. E-3 for latest catalog.



**insuline** CORPORATION OF AMERICA

INSULINE BUILDING • 36-02 35th AVENUE • LONG ISLAND CITY, N. Y.  
West Coast Branch and Warehouse: 1335 South Flower Street, Los Angeles, Calif.  
Exclusive Canadian Sales Agents: CANADIAN MARCONI COMPANY Montreal





ON LAND . . .

. . . SEA . . .



. . . AND IN THE AIR . . .

## . . . NEY PRECIOUS METAL ALLOYS *aid precision control and instrumentation*

If you are being called upon to design and build precision electrical and electronic apparatus for tough field service, be sure to write for a copy of the Ney book, "Precious Metals for Sliding Contacts and Non-Corrosive Wear Resisting Parts." New experience and wealth of successful application data in this specialized field may be the solution to one of your important problems. The book includes comprehensive technical data on Ney precious metal alloys together with photographs and dimension drawings of a wide variety of contacts, brushes and other components now standardized for production.

### THE J. M. NEY COMPANY

179 ELM STREET, HARTFORD, CONN.

SPECIALISTS IN PRECIOUS METAL METALLURGY SINCE 1812

7NY51



**TOUGH** as an elephant's trunk!

## Shatterproof Electrical Connectors

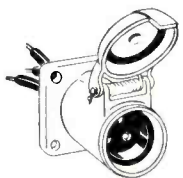

Unavoidable blows as well as careless handling quite often subject portable electrical connectors to punishment as bad as in the scene pictured above. When this happens many apparently good connectors develop cracked insulation . . . loose contacts or fail entirely.

Molded directly to cable as one-piece Neoprene units MINE'S plugs are Jerk-proof, Shatter-proof and Wear-resistant. Special construction and resilient rubber mounting of pins and spring loaded sockets insure a long life of positive contact under adverse conditions . . . and MINE'S famous Water-Seal automatically protects connections from moisture, dirt, oil, etc.

A wide variety of sizes, shapes and pin combinations are available to meet the portable power requirements of TV, FM, AM or PA Circuits. No. 3A156M Male Plug and No. 3A156F2X1 Female receptacle illustrated.

ME 1249 1

*Consult a  
Joy Engineer*



MINES EQUIPMENT — MINES — Division

## JOY MANUFACTURING COMPANY

HENRY W. OLIVER BLDG., PITTSBURGH 22, PENNA.



# NATIONAL

- **P**roven
- **D**ependable
- **Q**uality



## PRECISION-WOUND RF CHOKES

R-100 employs pigtail leads; the R-100U has pigtail leads and a removable stand-off insulator; the R-100S has cotter-pin lug terminals and a non-removable stand-off insulator. All available in 2.5, 5 and 10 mh. sizes rated at 125 ma. The R-100ST has a 6-32 threaded stud at each end—available in 2.5 mh. The R-33 series chokes are 2-section r.f. chokes available in 10, 50, 100 and 750 uh sizes, and are rated at 33 ma.

EXPORT DIV., Dept. E-351



Kenneth A. Kesselring of Westinghouse Electric Corp.; Andrew W. Edwards of Knolls Atomic Power Lab; and Robert W. Mayer of General Electric Co.

### Engineering Positions Available

CIVIL SERVICE positions for engineers are now open in the Office of Naval Research, Special Devices Center, Sands Point, Port Washington, N. Y. The work involves project engineering on complex devices such as operational flight trainers, simulators and computers. Experience in guided missiles, Army ordnance and Navy fire control equipment is desirable.

Grade GS-11 (\$5,400 per year) requires an aeronautical, electronic or mechanical engineering degree and three years of progressive professional engineering experience. Grade GS-12 (\$6,400 per year) requires a degree and four years of progressive professional engineering experience.

Applicants should complete Standard Form 57, the application for Federal employment (available at any post office), and report for an interview at the Civilian Personnel Office.

### BUSINESS NEWS

THE HENDERSON-SPALDING Co. of England has appointed the British Overseas Mart, Inc., 300 Fourth Ave., New York City, as sole American agent for the licensing of its patented Technograph process of printed circuit production.

KINGS MICROWAVE CO., INC. recently moved from New York City to 50 Marbledale Rd., Tuckahoe, N. Y.

ALTEC LANSING CORP. has opened a new plant in Beverly Hills, Calif. Over 30,000 sq ft are devoted to the assembly and testing of loudspeakers and amplifiers and to the complete fabrication of microphones.

THE SHELDON ELECTRIC Co. plant of Allied Electric Products Inc. has built a two-story addition to its main building in Irvington, N. J.,



**EVER TRY TO USE CONTROL MOTORS AND GEAR TRAINS THAT WERE**

## Almost Right?

If you have—then you'll join the fast-growing list of engineers and designers who appreciate the fact that there is no such thing as a "standard" Transicoil Control Motor or gear train assembly. Each and every unit is specifically made, both electrically and mechanically, for a specific job. Each is shipped to you ready for instant use without any fussing around trying to adapt units that are only "almost right".

**HANDY CONTROL MOTOR DATA CHART**  
Send for your free copy today.

Transicoil Products: CONTROL MOTORS,  
PRECISION GEAR TRAINS, INDUCTION  
GENERATORS, SERVO AMPLIFIERS



# TRANSICOIL

CORPORATION

107 GRAND STREET

NEW YORK 13, N.Y.

SEE US AT BOOTH 229, I.R.E. SHOW



# Leading Manufacturers\* Specify COMMUNICATION ACCESSORIES TOROIDAL COMPONENTS

\* Names on request...

## UNCASED COILS

Toroids close-tolerance adjusted to your specifications. Coils are heat cycled to maintain accuracy even in toughest service conditions. Toroids have low T/C characteristics, extremely low magnetic pickup and external field. Coils may be supplied with balanced windings, also can be tapped, or have multiple winding for tight coupled impedance transformation.

## PLASTIC COATED TOROIDS

Another C A C First. Our most progressive customers specify thermo-setting plastic coating for their coils, transformers, and tuned circuits. This tough resilient covering protects the coils and seals out moisture. Just another reason why the people who use toroids year after year specify C A C Toroidal Components.

## CASED TOROIDS AND FILTERS

Rugged steel cases, construction meeting military specifications. Coils giving highest Q per unit volume and special capacitors provide sharper and more stable filters with a compactness never before possible. A special design for your every requirement.

Send for this FREE booklet today...

COMMUNICATION ACCESSORIES

Company

HICKMAN MILLS, MISSOURI

to increase facilities for tube manufacturing.

PRECISION METAL PRODUCTS Co., manufacturer of electronic components, recently moved from Malden to Stoneham, Mass., to increase its manufacturing area.

LANSDALE TUBE Co., a subsidiary of Philco Corp., has purchased a site at Frederick, Md., for a new plant to manufacture electronic tubes for the Armed Forces and essential civilian requirements.

WESTINGHOUSE ELECTRIC CORP. has opened negotiations for a tract of land near the Baltimore, Md., Friendship Airport for a new plant to meet expanding military demand for products of the company's electronics and x-ray division.

MINNEAPOLIS-HONEYWELL REGULATOR Co., Brown Industrial Division, has expanded its output facilities by the purchase of the Thomas M. Royal plant and 60,000 sq ft of property adjacent to it in Philadelphia, Pa.

FIDELITY TUBE CORP. of East Newark, N. J., producers of tv c-tubes, have announced plans for the manufacture of miniature receiving tubes and radar tubes for use by the armed forces.

LYSCO MANUFACTURING Co., INC., is the new corporate name of LySCO Laboratories, Hoboken, N. J. George R. Scott, formerly with Mackay Radio, has joined LySCO as president and chief engineer.

## PERSONNEL

E. W. RITTER, with Westinghouse Electric Corp. since last April as a consultant, has been appointed manager of the company's newly formed electronic tube division. He will retain his headquarters in Bloomfield, N. J., for an indefinite period.

JOSEPH P. SPAULDING, formerly associated with the Naval Research Laboratory as a section head in the investigation and development of electronic devices, was recently appointed to the staff of the National Bureau of Standards, where he will

# SELENIUM RECTIFIERS

## OVER ONE MILLION AT WORK

Over 1,000,000 Selenium Rectifiers have been produced by International Rectifier Corporation during the past three years. These include miniature rectifiers, high voltage and high power rectifiers of many different designs and capacities, for a wide variety of applications.

We specialize *exclusively* on the design and manufacture of Selenium Rectifiers of top quality for peak performance. We cooperate closely with your *Engineers* in developing units to meet their requirements as to dimensions, weight, capacity and application. Your inquiry is invited.

### TYPE V-HF SERIES 5 MILLIAMPERES DC

Circuit-Half-Wave. In 9/16" OD Phenolic Tube with ferrule at each end for insertion in Fuse Clips. Overall length varies to 9" depending on the DC output voltage rating.

#### PARTIAL LIST OF TYPE V-HF SERIES RECTIFIERS AVAILABLE

DC Output Voltage	Rectifier Part No.	DC Output Voltage	Rectifier Part No.
40	V2HF	800	V40HF
80	V4HF	1500	V75HF
200	V10HF	2500	V125HF
600	V30HF	4000	V200HF

### TYPE Y-HP SERIES 11 MILLIAMPERES DC

Circuit-Half-Wave. In 9/16" phenolic tube with pigtail leads. The overall length of rectifiers in this series varies up to 9", depending on the DC output voltage rating.

#### PARTIAL LIST OF Y-HP SERIES RECTIFIERS AVAILABLE

DC Output Voltage	Rectifier Part No.	DC Output Voltage	Rectifier Part No.
20	Y1HP	1000	Y50HP
60	Y3HP	2000	Y100HP
100	Y5HP	3000	Y150HP
400	Y20HP	4000	Y200HP

### TYPE V-HM SERIES 5 MILLIAMPERES DC

Circuit-Half-Wave. In 3/8" metallic case with pigtail leads, the negative lead being grounded to the case. Overall length varies to 0.890", depending on the DC output voltage rating. Also available in hermetically sealed units.

#### PARTIAL LIST OF TYPE V-HM SERIES RECTIFIERS AVAILABLE

DC Output Voltage	Rectifier Part No.	DC Output Voltage	Rectifier Part No.
20	V1HM	160	V8HM
60	V3HM	200	V10HM
80	V4HM	220	V11HM
120	V6HM	240	V12HM

#### STANDARD SELENIUM CELL SIZES

Cell Type No.	U	V	Y	Z	W
Cell Diam. (In.)	1/8	1/4	3/8	1/2	1
Current Rating (ma.)	1.5	5	11	20	75

## INTERNATIONAL RECTIFIER CORPORATION

6809 S. VICTORIA AVE • LOS ANGELES 43

## automatic slideback peak pulse

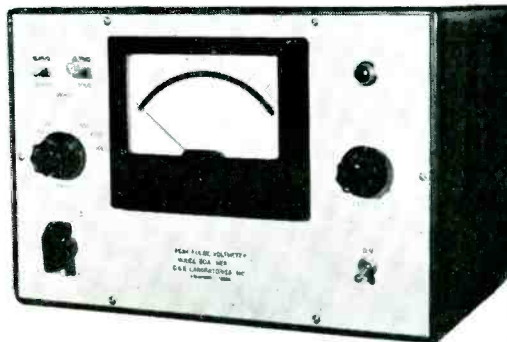

## VOLTMETER

Far more versatile than conventional types, the C.G.S. peak pulse voltmeter reads *rapidly* and *accurately* on pulse widths of .25 microseconds and at repetition rates of 10 pps. The instrument reads on either positive or negative pulses. Controls include an on-off, range selector and input polarity switch; zero set control. A switch which throws a D.C. restorer into the circuit provides accurate peak to peak measurements of sine and square waves.



#### SPECIAL FEATURES —

- Wide Voltage Range — 5 scales from 10 to 5000 volts full scale.
- Pulse Width 0.25 microseconds to 50 milliseconds.
- Accuracy  $\pm 3\%$  of full scale.
- Input Impedance 200,000 ohms.

Write for Catalog Sheet Giving Full Information — Or Contact Us Concerning Your Own Individual Problems. Our Staff is at Your Service. Write Dept. A



**C. G. S. LABORATORIES, INC.**  
LUDLOW STREET STAMFORD, CONNECTICUT

# THINKING OF STAINLESS...

THINK OF  
**ALLMETAL**

FOR THE  
FINEST IN

**STAINLESS  
STEEL  
FASTENERS**

FOR QUALITY  
AND DELIVERY

Complete facilities under one roof assures controlled quality and immediate delivery. Standard and "AN" specs. Specials to order.



ALLMETAL, Specialists in Stainless, Produce Stainless Products Exclusively

Write for  
Catalog C



MANUFACTURERS SINCE 1929

**ALLMETAL**  
SCREW PRODUCTS COMPANY, INC.  
33 GREENE STREET NEW YORK 13, N. Y.



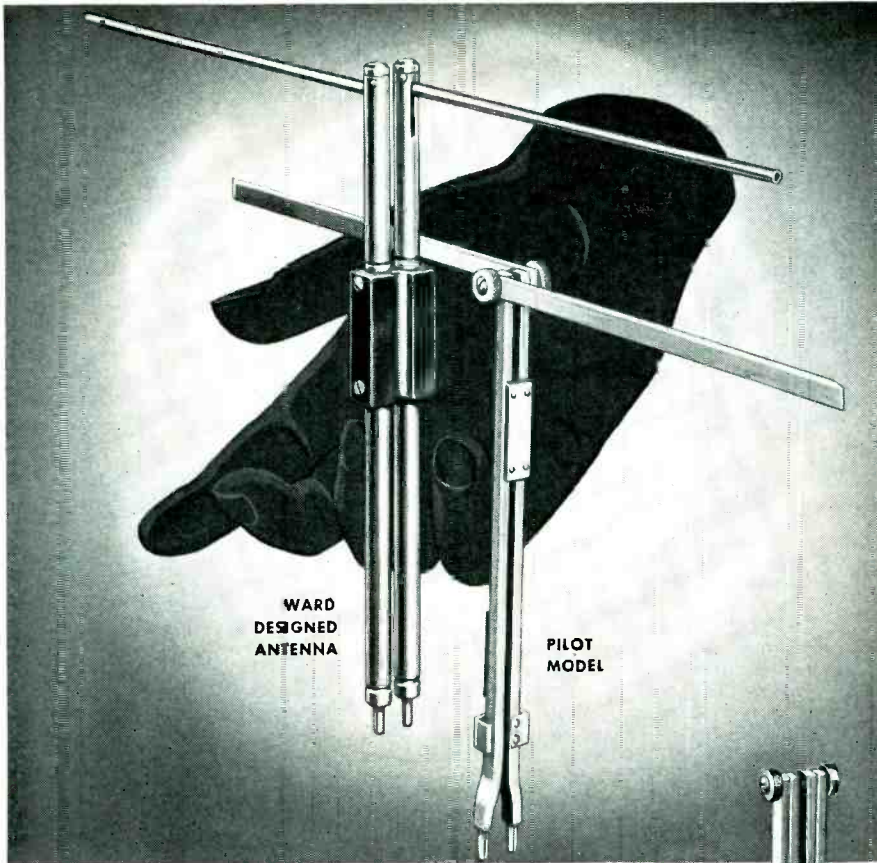

## a flick of the finger and broadcast begins

Designing an aerial for citizens radio offers a number of challenging problems. From the pilot model Ward engineered the production unit.

Sturdy mechanical design, light weight, high electrical efficiency are all combined with extreme simplicity of operation. A flick of the finger opens the antenna from its closed position, ready for operation.

Would you like the complete story of how Ward engineering can be applied to your problem? Whether you require one or thousands of special antennas, Ward's complete engineering facilities are at your service. Just 'phone or write.

**THE WARD PRODUCTS CORP.**

Division of The Gabriel Co.

1523 EAST 45TH STREET  
CLEVELAND 3, OHIO

only **WARD** OFFERS  
ONE SOURCE FOR  
SPECIAL COMMUNICATION  
TV-FM-AM and AUTOMOTIVE  
**ANTENNAS**

NEWS OF THE INDUSTRY (continued)

do electronic research in the Bureau's ordnance development division.

VANNEVAR BUSH, president of the Carnegie Institution of Washington, D. C., was awarded the John Fritz Medal at the AIEE Winter General Meeting, for outstanding scientific contributions to his country and to his fellow-men.

J. B. LINDSAY, previously associated with RCA Victor, has joined the engineering staff of Thomas Electronics, Inc., Passaic, N. J., manufacturers of tv picture tubes.

WILLIAM J. FLEMING, formerly vice-president in charge of engineering at the Trumbull Electric Mfg. Co., Plainville, Conn., has been transferred to the General Electric X-Ray Corp., Milwaukee, Wisc., as vice-president in charge of engineering and manufacturing.



W. J. Fleming



H. C. Tittle

HULBERT C. TITTLE, formerly engineering service manager, has been appointed assistant chief engineer for the radio and television division of Sylvania Electric Products Inc., Buffalo, N. Y.

ROBERT HARRIS, formerly a sales representative on tv products for Brach Mfg. Co., Newark, N. J., has been brought into the company's engineering department.

GUIDO FERRARA, assistant professor of electrical engineering at the University of Detroit, has been named acting director of the department of electrical engineering.

KURT APPERT, vice-president and chief engineer of Lenkurt Electric Co., San Carlos, Calif., since its founding in 1934, has become director of engineering there. The company manufactures wire-line and radio carrier equipment for telephone, telegraphy, telemetering and control.

**ONLY  
SPECIFIC COILS  
CAN DO  
THIS JOB-**



The Bobbin Type Coils shown below are part of a complex aircraft instrument assembly. No larger than your little fingernail, these tiny coils are mounted on a common core and activate three indicator needles within the same dial. Extreme assembly care and microscopic inspection, at Coto, assure perfect operation under adverse flying conditions.

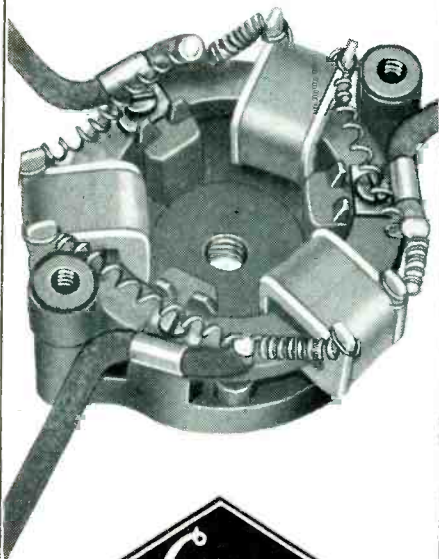

*Builds Them!*

When you need electrical coils, why not take advantage of 34 years of experience, engineering competence, and modern production facilities. Coto coils are built for you, to your specifications.

**COTO-COIL CO., Inc.**  
COIL SPECIALISTS SINCE 1917  
65 PAVILION AVE  
PROVIDENCE 5, R.I.

# PRODUCTION LINE TESTING

OF

## SERVOSCOPE

## SERVOMECHANISMS

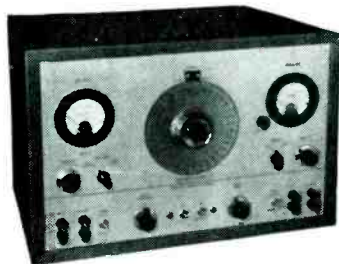

**SERVO CORPORATION  
OF AMERICA**

**NEW HYDE PARK  
LONG ISLAND  
NEW YORK**

**INVALUABLE IN RESEARCH**

**RAPID INSPECTION ON THE PRODUCTION LINE**

## A SERVO ANALYZER

- STANDARD RANGE: .1 TO 20 CYCLES PER SECOND
- SINE WAVE
- MODULATED CARRIER
- SQUARE WAVE
- READS DIRECTLY
- SERVO LAG OR LEAD IN DEGREES

There's only **1 FIRST**  
IN HIGH VOLTAGE POWER SUPPLIES

**ENGINEERS** . . . are specialists in the design and construction of high voltage equipment. They have pioneered in developing and supplying this type of apparatus to the fields of Electronic Engineering, Research, and Manufacturing. Beta Electric Corporation is proud to list, among its many pioneering innovations in the High Voltage field, these Beta "Firsts":

- FIRST** to SPECIALIZE in High Voltage Power Supplies.
- FIRST** with Portable 0-30 KV Adjustable Power Supplies.
- FIRST** to build 30-KV, 50,000 Ohm-per-volt Kilo-voltmeters.
- FIRST** to provide AC operated Electronic Microammeters for insulation resistance measurements.
- FIRST** to make available a Nation-wide Engineering Service on High Voltage Power Supply problems.
- FIRST** with Reversible Polarity 0-30 KV DC Portable Power Supply.

Our Field Engineers throughout the country are ready to discuss your high voltage problems and equipment needs with you. Beta builds power supplies to fit specific requirements for Voltage, Current, Regulation, Size, etc. Beta also makes and carries in stock a standard line of rugged compact DC Power Supplies up to 30 KV. Power supplies up to 250 KV are readily available from standard designs, and Beta can build your special power supplies up to 500 KV.

**WE WELCOME YOUR INQUIRIES**

**BETA ELECTRIC CORPORATION**  
333 East 103 St., New York 29



ments and then covers polarized antennas.

Offhand, one would not think it possible to write 600 pages on tv and other receiving antennas, but once you get into the subject it is evident that there is much to be said!—K.H.

### Static and Dynamic Electricity

BY W. R. SMYTHE. *McGraw-Hill Book Co., New York, 1950, Second Edition, 616 pages, \$8.50.*

THIS SECOND edition is a considerably revised and enlarged version of Professor Smythe's well-known textbook. The book is intended for a graduate course in electricity and magnetism and as such, has found wide use both as a text and as a collateral reference.

The average electrical engineering student will perhaps find this book somewhat on the difficult side for a first course in electromagnetic theory and will want to supplement it with a more elementary introduction to the subject. For those who have some background in the subject, the book will prove to be a mine of information on the methods and techniques of solving field problems. A large number of problems are worked out in some detail in the body of the text. In addition, the end of each chapter has an extensive collection of problems. Many of the results of the problems are listed in the unusually complete index, further enhancing the value of this book as a reference.

The material in the first three-quarters of the book follows the general pattern of the classic texts on "Electricity and Magnetism" written by Maxwell and by Jeans. The treatment is thoroughly modern and uses vector notation throughout. One very welcome change in the second edition is the use of rationalized MKS units.

The last quarter of the book contains chapters on electromagnetic waves, radiation, waveguides and resonators, and a brief treatment of special relativity. It is in this section of the book that the greatest changes will be found. The chapters on radiation and on waveguides are entirely new. One now finds a

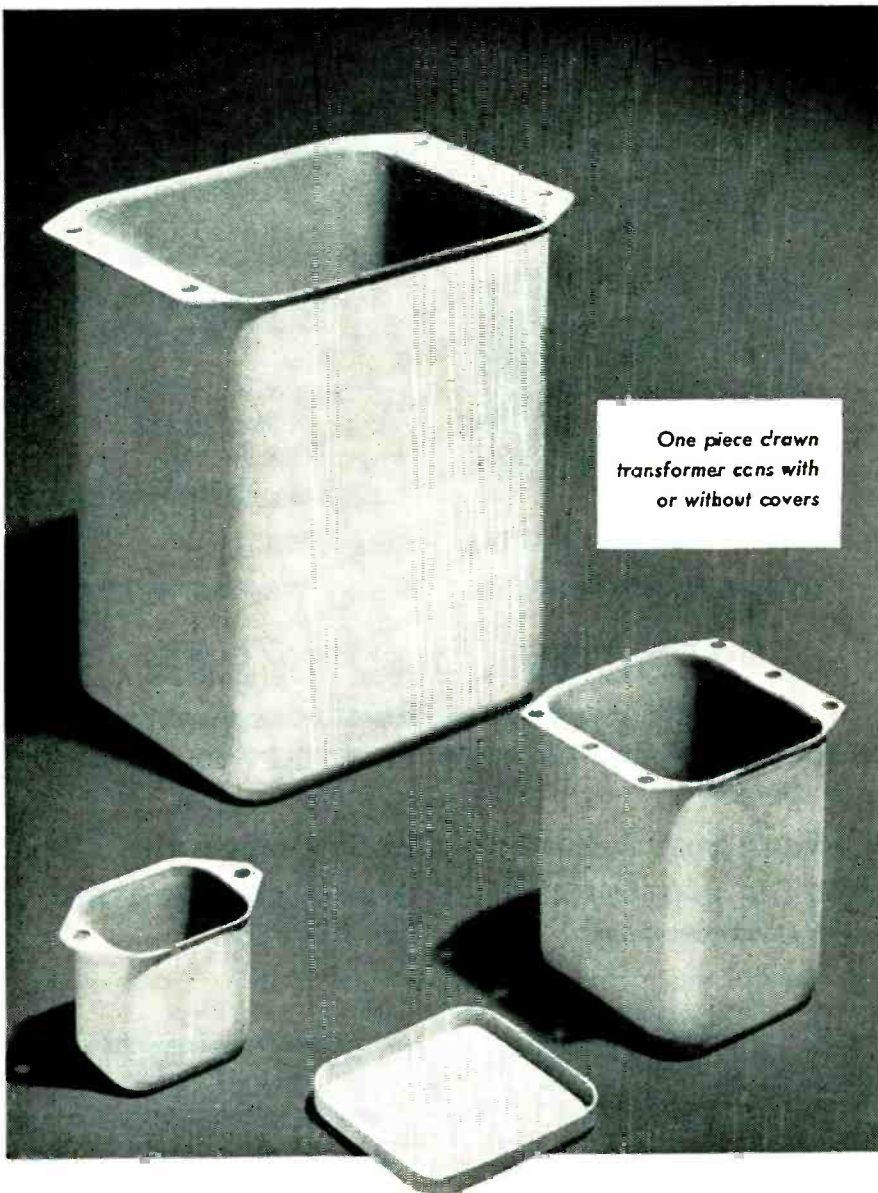

One piece drawn transformer cans with or without covers

## TRANSFORMER CANS STOCKED IN STANDARD SIZES

We can save you die costs on all stock size transformer cans, and will make IMMEDIATE DELIVERY. A full range of sizes are available with or without covers. List of stock sizes and prints furnished on request.

### SPECIAL SHAPES AND SIZES

We are also equipped to fabricate special sizes and shapes (round, square and rectangular) to your own specifications. Tell us your transformer can requirements and we will be glad to submit estimates.

Craft Transformer Cans are drawn in one piece.



**Craft** MANUFACTURING CO.  
3949 W. Schubert Ave., Chicago 47  
*Stainless Steel Specialists*

## 2 KW VACUUM TUBE BOMBARDER OR INDUCTION HEATING UNIT



For Only \$650.

Never before a value like this new 2-KW bench model "Bombarder" or high frequency induction heater . . . for saving time and money in surface hardening, brazing, soldering, annealing and many other heat treating operations.

Simple . . . Easy to Operate . . .  
Economical Standardization of  
Unit Makes This New Low Price  
Possible.

This compact induction heater saves space, yet performs with high efficiency. Operates from 220-volt line. Complete with foot switch and one heating coil made to customer's requirements. Send samples of work wanted. We will advise time cycle required for your particular job. Cost, complete, only \$650. Immediate delivery from stock.

Scientific Electric Electronic Heaters are made in the following ranges of Power: 1-2-3½-5-7½-10-12½-15-18-25-40-60-80-100-250KW.

*Scientific  
Electric*

Division of

"S" CORRUGATED QUENCHED GAP CO.

107 Monroe St., Garfield, N. J.

## AIRPAX 60—400 CYCLE CHOPPERS



meet rigid military specs; provide the maximum in reliability . . . precision and unusually long life for DC amplifiers and servo applications. Always supplied completely hermetically sealed.

## AIRPAX High Frequency VIBRATOR INVERTERS and POWER Supplies

are the smallest and lightest yet available. Supplied in power ranges from 3 to 300 watts; 400 cycles and higher . . . long-life and high efficiencies.



MIDDLE RIVER

BALTIMORE 20, MD.

Vibrators

Choppers

Inverters

Transformers

Power Supplies

# IF you use SILVER

## laminated to non-precious base metals in your products

. . . you will welcome the fast and efficient service of this 53-year old organization and find it a dependable source for the finest of materials . . . in sheet, wire or tubing.

Owner-management cuts red tape . . . speeds production . . . assures you of interested attention and complete satisfaction.

*Your inquiries will  
be appreciated and  
replied to . . . promptly.*



**The Home of IMPROVED Service**

**The IMPROVED SEAMLESS WIRE COMPANY**  
INCORPORATED 1898

775 Eddy Street, Providence 5, Rhode Island



# Cut Polishing Time Improve Surface Quality

with "LINDE" FINE ALUMINA POWDERS

Now, you can choose the type of finish you want, free from microscopic pits and scratches, on metallic and non-metallic surfaces. And you can get these superior results in a fraction of the usual polishing time by using ultra-fine LINDE abrasive powders.

Because of extremely uniform particle size and form, smaller amounts of LINDE Fine Alumina Powders go further. You can use them directly from the container without expensive preparatory steps—or compound them with waxes and other vehicles to suit your need.

Two types are available. Type A is a quick-acting powder of hexagonal structure and sapphire hardness. Type B produces a still finer polish, almost as quickly.

LINDE Fine Alumina Powders may be the answer to your polishing problems. They have already gained acceptance in polishing metallographic specimens, gemstones, and other materials. Call or write any LINDE office to find out how these powders can be used to advantage in your particular polishing applications.

The term "Linde" is a trade-mark of Union Carbide and Carbon Corporation.

	Type A	Type B
Chemical Composition.....	Alpha $Al_2O_3$	Gamma $Al_2O_3$
Particle Size (approximate).....	0.3 Micron	Less than 0.1 Micron
Hardness (Mohs) (Equivalent to crystalline material).....	9	8
Crystalline Structure.....	Hexagonal	Cubic

## LINDE AIR PRODUCTS

A Division of Union Carbide and Carbon Corporation  
30 East 42nd St., New York 17, N.Y. ☎ Offices in Other Principal Cities  
In Canada: DOMINION OXYGEN COMPANY, LIMITED, Toronto

treatment of such topics as biconical antennas, radiation from apertures, modes in waveguides and resonators, discontinuities in waveguides, coupling to guides and cavities, and numerous other boundary-value problems that are encountered in microwave work.

On the whole, the book treats its material in a thorough and up-to-date manner. The only part of the book which might be considered out of date by the electrical engineer are the chapters on Transient Phenomena and on Alternating Currents. These two chapters appear out of place in a text which deals mainly with field theory. In addition, since they were originally written for the first edition, use of the methods of the Laplace transform and of function theory have become relatively commonplace and any treatment of transients and of networks would not be doing justice to the subject without the use of these powerful mathematical tools. Because an adequate treatment of these two subjects would require several volumes, the reviewer feels that these two chapters might better have been omitted and the space used for further topics in the microwave field.

Aside from this minor comment, the book is highly recommended to those engineers and physicists who have any occasion to work with field problems. The unusual number of applications worked out makes it useful as a handbook of boundary value problems. If an analytic solution to a field problem exists, the chances are reasonably good that it will be found in this book.—HENRY JASIK, *Airborne Instruments Laboratory*.

## Fundamentals of Acoustics

BY LAWRENCE E. KINSLER AND AUSTIN R. FREY, both of the *United States Naval Postgraduate School, Annapolis, Maryland*. John Wiley and Sons, Inc., New York, 1950, 516 pages, \$6.00.

THIS BOOK is a lucid and concise presentation of the fundamentals of acoustics. There are chapters devoted to simple harmonic motion, the vibrations of strings and bars, plane and spherical acoustic waves, transmission phenomena in fluids

# HEINTZ AND KAUFMAN introduces a versatile TRANSMITTER

Type A-4912

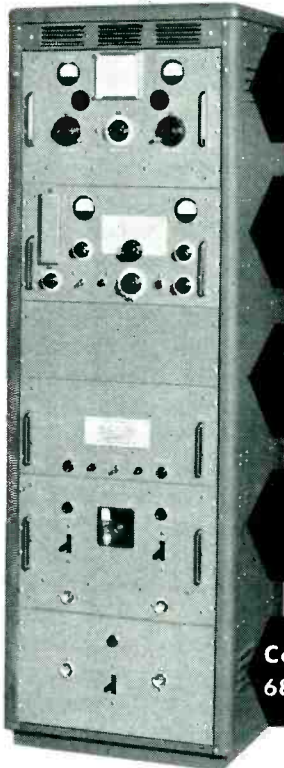

Frequency  
Range:  
2-27 mcs.

Four  
Types of  
Emission

100-400  
Watts  
Output

Up to  
500  
W.P.M.

Compact:  
68"x22"x17"

## FOR MARINE, AVIATION AND LAND SERVICE

This general purpose Heintz and Kaufman transmitter is designed to serve a multitude of communication needs. In the field of aviation it provides both ground-to-air communication, and airport-to-airport radio-teletype service.

**FREQUENCY RANGE:** 2 to 27 mcs., continuous coverage with an 8 band exciter and 5 band power amplifier. Space for 10 crystals.

**POWER OUTPUT:** A-1 (telegraph service) or Frequency Shift transmission, 400 watts; A-2 (modulated c.w.), 250 watts; A-3 (telephone), 100 watts.

**KEYING SPEED:** Electronic make-break keying to 200 w.p.m. With minor changes in key-click filter, keying speed can be increased to 500 w.p.m.

For detailed information ask for  
Engineering Bulletin A-4912

 **Communication  
Equipment Division**  
**THE ROBERT DOLLAR CO.**  
50 DRUMM STREET • SAN FRANCISCO, CALIF.  
Export: The M. Simons & Son Co., 25 Warren St.,  
New York City Cable: SIMONTRICE

# Flexible-Shaft Couplings

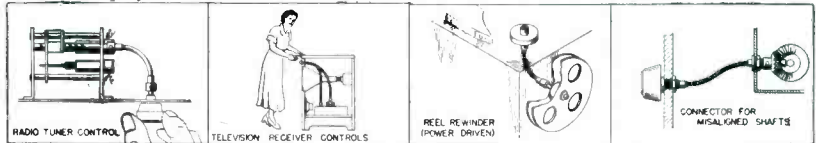
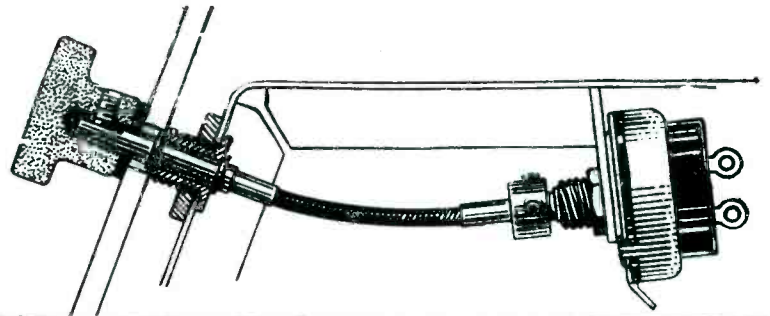

- MORE LIBERAL MANUFACTURING TOLERANCES
- CUSTOM BUILT FROM STANDARD COMPONENTS
- SHAFTING AVAILABLE IN DIFFERENT SIZES
- ECONOMICAL TO USE
- GREATER FREEDOM OF DESIGN
- STANDARD END FITTINGS

Write for bulletin showing

- DESIGN DATA
- STANDARD END FITTINGS
- TYPICAL FLEXIBLE SHAFT PROPERTIES



**WIRE SHIELDING & PUSH-PULL CONTROLS**

**KUPFRIAN MANUFACTURING CO.**

218 PROSPECT AVE. BINGHAMTON, N. Y.  
FORMERLY A DIVISION OF ELLIOTT MANUFACTURING COMPANY

See us at Booth 372 at the I.R.E. Show

## the right combination

AiResearch Rate  
of Change  
Control



## FOR THE RIGHT CABIN PRESSURE

The AiResearch Rate of Change Control regulates the rate at which pressure in the airplane's cabin changes. An A. W. Haydon Motor was chosen to drive the instrument because of its proved performance record in scores of important aircraft applications. Other functions for which similar A. W. Haydon Motors are used include controls for wing and propeller de-icing, propeller feathering, camera intervalometer, hydraulic bypass, fuel tank purging as well as recorder chart drives, trim control, telemetering and destructor control, etc.

Send for  
complete catalog. 

A. W. Haydon  
Standard D.C. Tim-  
ing Motor No. 5301

 **The  
A.W. HAYDON  
COMPANY**  
235 NORTH ELM STREET  
WATERBURY 20, CONNECTICUT  
Design and Manufacture of Electrical Timing Devices



# WHEN YOU NEED A MINIATURE TRANSFORMER

NEW PRODUCTS

(continued)

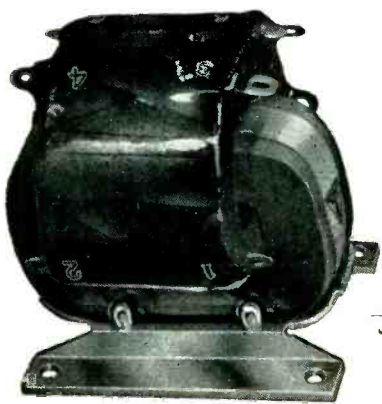

## CHECK THESE FEATURES OF THE HORNET

- ✓ **SIZE AND WEIGHT** Because they are designed for high operating temperatures, Hornet Transformers and Reactors have only about one-fourth the size and weight of Class A units of comparable rating.
- ✓ **VOLTAGE RATINGS** Designs are available for RMS test voltages up to 10,000 volts at sea level, and up to 5,000 volts at 50,000 feet altitude. Power ratings from 2VA to 5KVA.
- ✓ **POWER FREQUENCIES** These units are designed to operate on 380/1600 cps aircraft power supplies, 60 cps power supplies, and any other required power frequency.
- ✓ **AMBIENT TEMPERATURES** Hornet Units can be designed for ambient temperatures up to 200 deg. C. Size for any given rating depends upon ambient temperature and required life.
- ✓ **LIFE EXPECTANCY** Extensive tests indicate that the life expectancy of Hornet units at continuous winding temperatures of 200 deg. C. is over 50,000 hours.
- ✓ **MOISTURE RESISTANCE** Since Hornet Transformers and Reactors contain only inorganic insulation, they are far more moisture resistant than conventional Class A insulated units.
- ✓ **EFFICIENCY** Regulation and efficiency of Hornet Transformers compare favorably with Class A units.
- ✓ **SPECIFICATIONS** Hornet Transformers meet the requirements of Government specifications covering this type of equipment.



Bulletin B300, containing full electrical and dimensional data on Hornet units, is now available. Write for it, or tell us your specifications for special units.



**NEW YORK  
TRANSFORMER CO., INC.**  
ALPHA NEW JERSEY

and gases, resonators and filters, absorption phenomena, electro-mechanical transducers, the psychology of hearing, architectural acoustics, underwater sound and the inevitable final chapter on ultrasonics.

The first nine chapters are intended to be the basis for a one-semester course in the theory of acoustics. For this, the student should have a good knowledge of the fundamentals of mechanics, electricity and calculus, including partial derivatives. The last seven chapters are intended for the second semester's work, and illustrate the mathematical techniques developed in the earlier chapters. There are comprehensive sets of problems for each chapter. However, this book is definitely not for home study or self-instruction. The extreme conciseness of many chapters, together with a paucity of bibliographical references, make the services of a teacher quite necessary. The book is intended for advanced undergraduate or graduate students, and it will also serve admirably as a refresher course for those who have had previous education in acoustics.

Many acoustical problems, particularly those relating to resonators and filters, are treated by means of electromechanical analogies.

The authors are members of the Acoustical Society of America, and their writing evinces a genuine interest in this field.—CURTISS R. SCHAFER, *Ridgefield, Conn.*

### Electronic Equipment Construction

*Published at Stanford University, and available from Office of Technical Services, Department of Commerce, Washington, D. C., about 300 pages, \$7.00.*

THE EVER-INCREASING amount of electronic equipment carried by military vehicles today has brought about the need for new materials and techniques. This book is a survey of new developments resulting from a program of maintenance minimization established at the Stanford Research Institute by the Office of Naval Research. Included are latest details on high-reliability

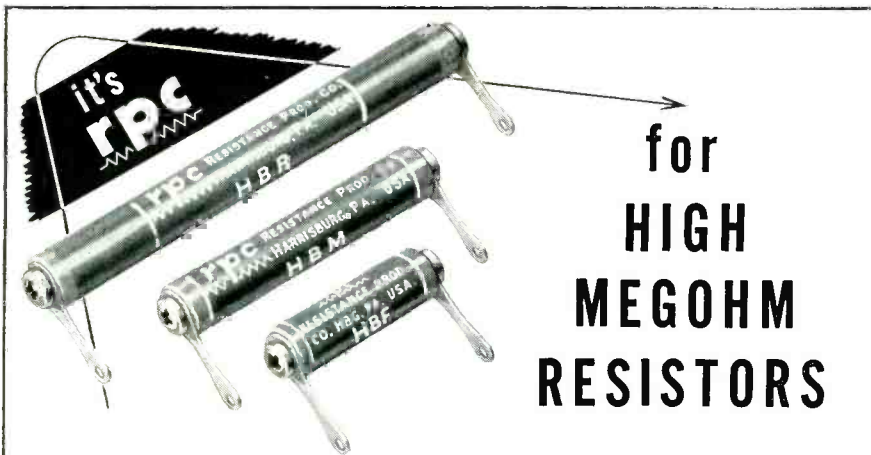

## for HIGH MEGOHM RESISTORS

**RPC** Type H Resistors are furnished with resistance values as high as 50 million megohms ( $5 \times 10^{13}$  ohms). Their advanced design insures highest stability with extremely low noise level, polarization effects, and voltage and temperature coefficients. Available in sizes suitable for any circuit requirement. Standard resistance tolerance  $\pm 10\%$ .

RPC Type H Resistors are rugged, durable units jacketed in polyethylene to provide maximum protection against mechanical damage and humidity. These resistors are eminently suited for electrometer circuits, radiation equipment, photo cell circuits and as high resistance standards. Moderately priced. Write for catalog today.

ALSO MANUFACTURERS OF HIGH QUALITY PRECISION WIRE WOUND RESISTORS, HIGH FREQUENCY RESISTORS AND HIGH VOLTAGE RESISTORS. WRITE TODAY FOR CATALOG.

**rpc** RESISTANCE PRODUCTS CO.  
714 RACE STREET • HARRISBURG 2, PA.

## PIX WIRE FORMING SPECIALISTS

Precision Parts to meet your Production and Engineering needs. From .002" dia. to .125" dia. Radio tube parts—Stampings—Drawings Modern facilities, high-production equipment.

Metal Crystal Holder Parts

Send sketch or print for quotation.

PIX MANUFACTURING CO., Inc.  
24 Bedford St., Newark 3, N. J.

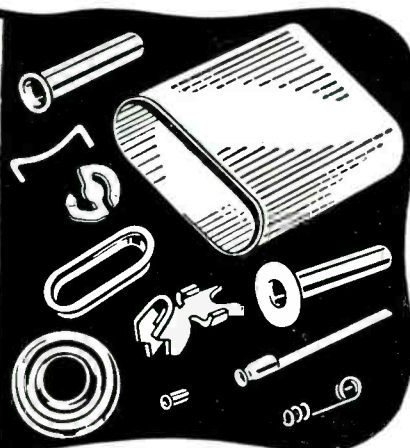

## HIGH VOLTAGE POWER Supplies

Up to 250,000 volts

A.C. or RECTIFIED and FILTERED

**SPECIAL INDUSTRIAL X RAY EQUIPMENT  
FOR INSPECTION • GAGING • ANALYSIS...**

We Will Design, Engineer and Manufacture to your requirements.  
SEND FOR BULLETIN 131

**BRACKE-SIEB X RAY COMPANY INC.**  
293 B THIRD AVENUE NEW YORK 10, N. Y.

## FOR COMPLETE TESTING

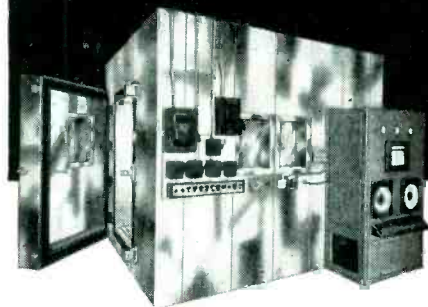

## WALK-IN ROOMS

by **BOWSER  
TECHNICAL  
REFRIGERATION**

Bowser Walk-In Rooms have a temperature range from  $+180^{\circ}\text{F}$ . to  $-100^{\circ}\text{F}$ . and relative humidity simulation from 20% to 95%. Because of sectionalized panel construction any size or shape room can be manufactured for final assembly in the field. Smaller sizes are preassembled at the factory. Extended ranges of temperature, humidity and provision for altitude simulation can be provided. Special accessories and instrumentation also available.

*Standard Environmental  
Simulation Chambers —  
Wide range of sizes  
and performance ratings.  
Meet all Govt. test specs.*

**BOWSER TECH. REFRIG., Terryville, Conn.**

Send me more information on the following:

- |                         |                          |                         |                          |
|-------------------------|--------------------------|-------------------------|--------------------------|
| Walk-in Chambers        | <input type="checkbox"/> | High Altitude Tests     | <input type="checkbox"/> |
| High Temp. Tests        | <input type="checkbox"/> | Mildew Resistance Tests | <input type="checkbox"/> |
| Low Temp. Tests         | <input type="checkbox"/> | Sand & Dust Tests       | <input type="checkbox"/> |
| Fungus & Humidity Tests | <input type="checkbox"/> | Explosion Proof Tests   | <input type="checkbox"/> |

Name \_\_\_\_\_ Pos \_\_\_\_\_

Company \_\_\_\_\_

Street \_\_\_\_\_

City \_\_\_\_\_ Zone \_\_\_\_\_ State \_\_\_\_\_

SE

## BOWSER

**TECHNICAL REFRIGERATION**  
DIVISION BOWSER INC.  
TERRYVILLE • CONN.



# RAYTHEON

## MAGNETIC COMPONENTS FOR MILITARY APPLICATIONS

Raytheon Voltage Stabilizers, Transformers and other Magnetic Components are noted for reliability in the most exacting military service. As a leading manufacturer for 20 years, Raytheon has developed engineering and production facilities which enable it to produce highest quality components to meet the most rigid MIL requirements. Write for complete information.



### VOLTAGE STABILIZERS

Precision built to provide maximum voltage stabilization with minimum variation in output voltage. An essential component for all electronic or electrical equipment requiring constant voltage for dependable, accurate operation. Available in catalog models from 15 to 2000 watts output capacity . . . or custom-engineered to suit special applications.

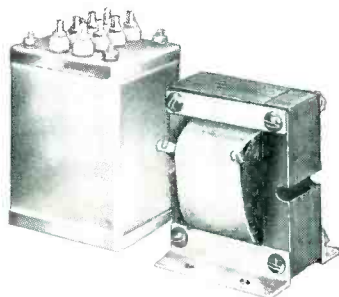

### CUSTOM-BUILT TRANSFORMERS

Individually engineered to meet the most exacting military or commercial requirements. Typical units include: single or polyphase power transformers, pulse transformers, servo transformers, chokes, saturable magnetic components, etc. Cased or open types to meet MIL specifications as well as Underwriters' Laboratories and R. M. A. requirements.

#### Write for Complete Information

Raytheon Products include Mariners Pathfinder\* radar; Fathometers\*; radio and television receivers; tubes; microwave communications; electrostatic air cleaners; Weldpower\* welders; voltage stabilizers; Recticharger\* battery chargers; Rectifilter\* battery eliminators; Rectringers\*; transformers; Microtherm\* diathermy; fractional hp motors, and other electronic equipment.\*®

Magnetic Components Division, Dept. 6460-A

**RAYTHEON MANUFACTURING COMPANY**  
Waltham 54, Massachusetts

vacuum tubes, tantalum electrolytic capacitors, cracked carbon resistors and stable inductor elements printed on ceramics. Sections are also devoted to operational experience with printed circuits and hermetically-sealed subassemblies.

Different components are treated separately and in logical order. For instance, in the section on resistors, each type is discussed with respect to historical background, production techniques, voltage and temperature coefficients, available wattage ratings, physical configurations, life expectancy, operation under unusual circumstances and names of manufacturers. The presentation is not in the form of tabular material, listing each manufacturers list, but rather in almost story form with the most important characteristics emphasized to attract the attention of the reader.

The greater portion of the book is devoted to the description of various production techniques developed by various companies and government agencies in recent years. Abundant illustrations add substantially to the value of the book as a reference. Also included are brief summaries of the facilities available at the larger companies, government agencies and educational institutions connected with the electronics industry.

The book should find many uses for small and large companies engaged in the development or production of military electronics equipment. It represents a quick and interesting resumé for keeping abreast of the changing industry.—  
J.D.F.

### Radio Communication at Ultra High Frequency

BY J. THOMSON. *John Wiley & Sons, Inc., New York, 1950, 203 pages, \$4.50.*

AN AUTHORITATIVE treatment of radio communication at ultra high frequency. Mathematical analyses of circuits and of circuit components are clear and concise. While the book covers both theory and practice, the emphasis is largely on theory. One could wish that more space had been devoted to fundamental electromagnetic wave theory and that some of the illustrations

# PHALO

**INSULATION  
THERMOPLASTIC  
Nothing Finer!**

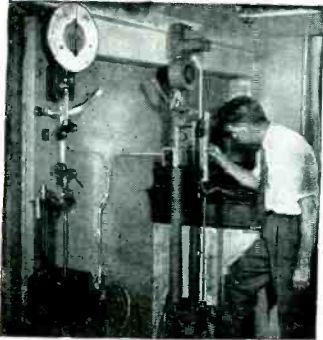

Why is Phalo wire and cable "Current's Favorite Conductor"?

The answer is found in the careful attention to detail Phalo exercises on every order. This talent for producing the best possible insulation for your particular job stems from years of experience in the highly specialized field of Thermoplastic insulation. Make use of Phalo's developed knowledge.

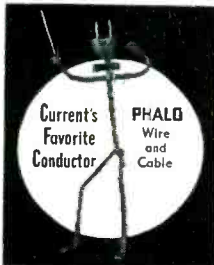

Your inquiry will have our prompt attention.

Ask for the latest Phalo catalog.



**PHALO**  
*Plastics Corporation*

Corner of Commercial Street  
Worcester, Mass.  
Manufacturers of Thermoplastic Insulated wire, cables, cord sets and tubing

## Maximum Reliability Every Time with AIRPAX CHOPPERS



now . . . the A586

### 60 CYCLE CHOPPER

Precision engineered  
for reliability . . .

for amplification of low level DC signals . . . The A586 is supplied hermetically sealed . . . almost unaffected by shock, vibration, temperature extremes.



MIDDLE RIVER

BALTIMORE 20, MD.

Vibrators

Choppers

Inverters

Transformers

Power Supplies

CONTINUOUSLY

## VARIABLE FILTERS

MODEL 302

VARIABLE  
ELECTRONIC  
FILTER



### "Another SKL first"

The — SKL — Model 302 includes two independent filter sections, each having a continuously variable cut-off range of 20 cps to 200 KC. Providing a choice of filter types each section has 18 db per octave attenuation. When cascaded 36 db is obtained in the high and low pass setting and 18 db in the band pass position. With low noise level and 0 insertion loss this versatile filter can be used as an analyzer in industry and the research laboratory or to control sound in the communications laboratory, radio broadcasting, recording and moving picture industries.

#### SPECIFICATIONS

- CUT-OFF RANGE  
20 cps to 200 KC
- SECTIONS  
2—can be high, low and band pass
- ATTENUATIONS  
36 db/octave maximum
- INSERTION LOSS . 0 db
- NOISE LEVEL  
70 db below 1 volt
- FREQUENCY RESPONSE  
2 cps to 2 MC

**SKL SPENCER-KENNEDY LABORATORIES, INC.**  
181 MASSACHUSETTS AVE., CAMBRIDGE 39, MASS.



were not quite so sketchy but, aside from this, the author has done a remarkably good job of explaining a very difficult subject. The section devoted to waveguides and resonators is an outstanding example of this.—OSCAR E. PIERSON, *Western Union Laboratory, Water Mill, N. Y.*

### Electronic Valves

*Philips Technical Library. Book I—Fundamentals of Radio Valve Technique, by J. Deketh, 547 pages \$5.00. Book II—Data and Circuits of Receiver and Amplifier Valves, 1933-1939, 406 pages, \$2.75. Book III—Data and Circuits of Modern Receiver and Amplifier Valves (First Supplement, 1940-1941), 213 pages, \$1.90. Book IV—Application of the Electronic Valve in Radio Receivers and Amplifiers, by B. G. Dammers, J. Haantjes, J. Otte, and H. Van Suchtelen, 416 pages, \$5.00. Distributed in U. S. by Elsevier Publishing Company, 215 Fourth Avenue, New York 3, N. Y.*

THESE BOOKS are the first four of a series of seven to be published by members of the staff of the Philips Gloelampenfabrieken (Netherlands). Books I and IV are in the nature of technical texts, while Books II and III are essentially tube handbooks. These books have all been written in Dutch and have been translated and published in French, German and English, and Book I, in addition, in Swedish, Italian, Spanish and Finnish.

The tube handbooks (II and III, and one yet to be published, III A) are, of course, of restricted use in this country because of the limited use of the Philips tubes. There are several interesting features of them, however, which our own handbook publishers could well duplicate. In addition to the essential characteristics for each tube, there are discussions, with circuits shown, for special applications for which the tubes are particularly suited. In expanded form, these application notes are available from some of the manufacturers in this country, but the particular form of presentation in these books seems quite effective. The use of semi-log scales for showing the plate current-grid voltage characteristics is something which is highly desirable.

Books I and IV are technical texts which again will be of rather

**You DON'T NEED A CRYSTAL BALL ..TO TELL YOU WHY**

**GLASER ELECTRON ROSIN CORE SOLDER**

**Glaser** **LECTRON ROSIN CORE SOLDER**

**Speeds Soldering Operations on the Production Line**

Many manufacturers in the radio, electronic, and television industries do not gaze into a crystal ball to discover why their soldering operations show a 15% increase in speed. They know, GLASER ELECTRON ROSIN CORE SOLDER, made with an exclusive activated rosin flux, is the reason for this speed-up in production.

GLASER ELECTRON ROSIN CORE SOLDER bonds copper and brass perfectly and permanently—yet is non-corrosive and non-conductive. Superior to any other activated rosin core solder made.

Profit from the experience of the many economy minded manufacturers. Speed up work on your production line—insist on a proven leader, GLASER ELECTRON ROSIN CORE SOLDER.

GLASER PLASTIC ROSIN CORE SOLDER has gained a well deserved leadership in the industry because of its highest standard of quality. Both GLASER ELECTRON ROSIN CORE and GLASER PLASTIC ROSIN CORE SOLDERS are made of the purest virgin tin, lead and perfect flux and are available in any tin-lead alloy and wire gauge.

#### OTHER GLASER PRODUCTS

Glaser Solder Preforms, Glaser Bar, Ingot or Solid Wire Solder. Glaser Fluxes for every purpose.

Our Engineering Department will gladly assist you with any soldering or flux problem, without obligation.

GLASER LEAD CO. INC.

21-31 WYCKOFF AVENUE

BROOKLYN 27, N. Y.



RENDERING DEPENDABLE SERVICE TO AMERICAN INDUSTRIES SINCE 1922



Here's Sun Radio's  
Big, New Catalog  
Of Electronic Supplies

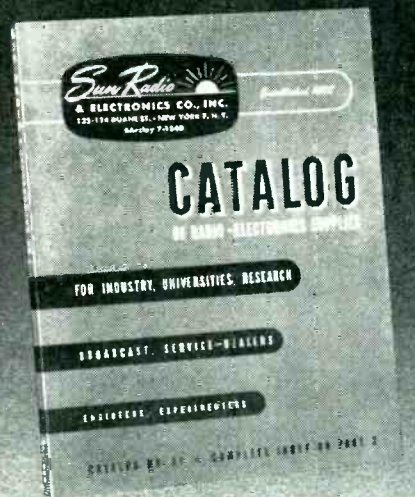

Designed to Meet  
YOUR Requirements

A brand new concept in electronic components catalogs. 132 large, easy-to-read, easy-to-use, 8 1/2 x 11" pages containing all the information you want on every item you need. Listing electronic components only, there's no need to wade through page after page of radio sets or other consumer products. Complete listings for the engineer, research worker, teacher, broadcast station, repair and maintenance man. Be sure you have this new catalog on your desk when you need it. Write or come in today for a FREE copy. Dept. C-E

See Us in Booth 319 (third floor) at the IRE Show.



TWO BLOCKS NORTH OF CHAMBERS STREET  
Established 1922 • Open Daily 9-6, Sat. 9-4:30

ELECTRONICS — March, 1951

# POWER

is not measured  
by size

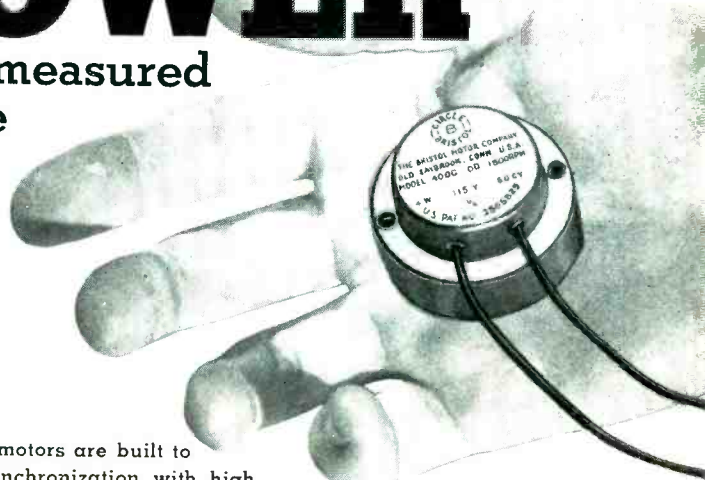

Bristol circle B motors are built to attain rapid synchronization with high pull out torque under varied load conditions.

### CHECK THESE BRISTOL FEATURES

- Compact, round, totally enclosed.
- Designed to fit in a 2" circle
- Delivers over 12 in. ounces torque at 1 RPM with less than 4 watt input.
- Speeds available from 1 RPM to 1800 RPM.
- Especially adapted for built-in use to control single or sequence of operations.
- Designed for continuous or intermittent service where long life is essential.
- Built for use in timers and elapsed time indicators where 100% dependability is essential.
- Each motor individually tested at factory.



For further details write:

## BRISTOL MOTOR CO.

51 Bristol Building  
Old Saybrook, Connecticut

## PRECISION

in ceramics ???

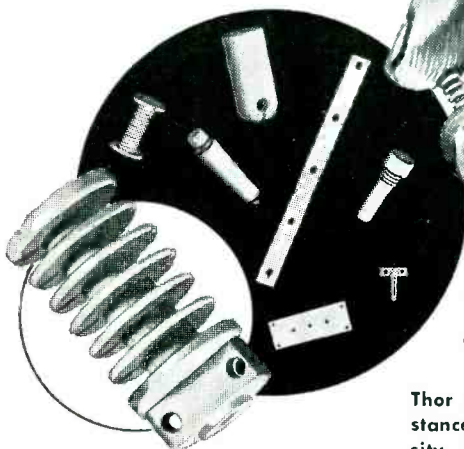

GET MORE!  
Consult "THOR"

Thor is a new, synthetic insulating substance which, because of its greater density, is easily milled, drilled, pressed, planed, lathe-turned, ground, or worked by any process applicable to metals! Thor combines the advantages of close-tolerance production with ideal electrical characteristics of high breakdown voltage, low surface conductivity, low loss at extremely high frequencies, and non-porosity. Its hardness (crush resistance factor of 100,000 lbs. psi) facilitates high-speed precision production to meet JAN Specs or your requirements at low unit cost. For information on custom manufacture in quantity of your item, please address:

## Thor Ceramics, Inc.

225 Belleville Avenue

Bloomfield, New Jersey





# SUBMINIATURIZATION

— is our specialty

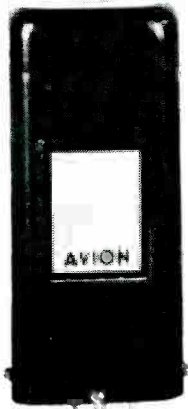

## AVITRON Type 30-B

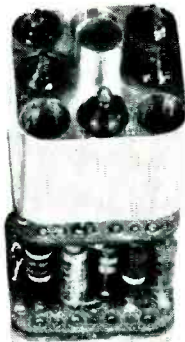

This eight tube chassis is the size of one standard tube, has octal base for instant plug-in, weighs less than a pound. Heat dissipation up to 15 watts.

## GYRO Type 50-A

Reference Gyro, high accuracy, used in guided missiles.

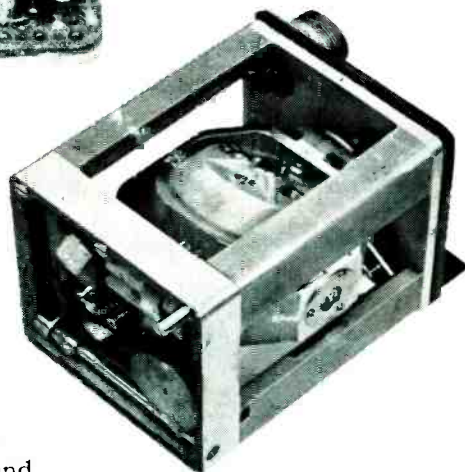

Where savings must be made in space, weight and power requirements—let AVION repackage your circuits quickly and economically. The work will be done in our new plant at Paramus, N. J.

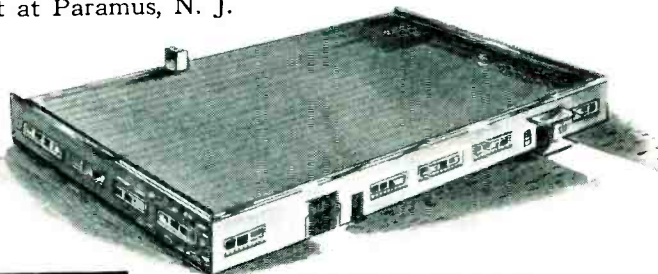

SEND SPECIFICATIONS TO —

# AVION INSTRUMENT CORP.

121 EAST 24th ST., NEW YORK 10, N. Y.

AT RADIO ENGINEERING SHOW — BOOTH 333



restricted use. Book I is not, as its title implies, a text on design and construction of tubes, but is more in the nature of a book on tube characteristics and their relation to the attached circuits. It is almost completely concerned with low-frequency, narrow-band applications and for these purposes, goes into great detail. Book IV is also concerned with narrow-band applications, particularly broadcast receivers, with sections on r-f and i-f amplification, frequency-changing, interferences and distortion, and detection. It is quite similar, in many ways, to Sturley's "Radio Receivers".

The translation is fairly good, although it is surprising that it is not better. Philips has available, in its many subsidiaries in English-speaking countries, many excellent engineers who could have eliminated much of the unevenness of some sections of the text. The books are well printed and, for present day standards, quite inexpensive.—  
MATT LEBENBAUM, *Airborne Instruments Laboratory.*

## THUMBNAIL REVIEWS

**APPARATUS NOISE MEASUREMENT.** ASA publication Z24.7-1950. American Standards Association, 70 E. 45, New York, 12 pages, 50 cents. Presents standardized methods of conducting and recording sound-level tests on radio, air conditioning, refrigeration and other equipment. Covers measurement of direct air-borne noise, reflected sound, ambient sound, apparatus mounting, location of microphone and standing waves.

**TAX ASPECTS OF PATENTS, COPYRIGHTS AND TRADE-MARKS.** By P. Gitlin and W. R. Woodward. Practising Law Institute, 57 William St., New York, 1950, 79 pages, \$2.00. Methods of reporting gains and losses; permissible income tax deductions for research on inventions and research prior to writing technical books; legal means of mitigating tax burden when income is concentrated in one year or when rights are sold; option of treating creative work as capital asset; treatment of litigation, advertising, promotion and other business expense; deductions for depreciation and obsolescence; tax problems raised by death of owner of patent or copyright.

**MOVIES FOR TV.** By John H. Battison. The Macmillan Co., New York, 1950, 376 pages, \$4.25. Principles and operation of television transmission equipment used for film; kinescope recording; program production techniques; getting releases from people showing on film programs.

**ECONOMIC ASPECTS OF ATOMIC POWER.** By S. H. Schurr and J. Marschak. Princeton University Press, Princeton, N. J., 1950, 289 pages, \$6.00. Compilation of chapters by various authors, analyzing the practicality and economics of atomic power in selected industries and the overall relation to national economy.

## Electronic Advances!

Keep pace with the swift engineering progress of Radio-Television - and - Electronics! The great annual Convention of the Institute of Radio Engineers serves to keep its members and visitors up-to-the-minute on electronic advances.

29 Technical Sessions and 14 Symposia have been skillfully organized to keep you "up-to-the-minute" on Advances in these subjects. In fact, many of the papers forecast new trends that are years ahead!

	Sessions
Amplifiers .....	2
Audio .....	2
Broadcast & Communications .....	7
Circuits .....	5
Computors .....	2
Instrumentation .....	2
Micro Waves .....	5
Military & Aviation .....	3
Nucleonics .....	2
Television & Color .....	4
Vacuum Tubes .....	5
Theory & General .....	4

(43 Meetings, 210 Papers)

You cannot invest four days more advantageously, or see more in product advances, prepared for you by manufacturers in the Radio Engineering Show.

The U. S. Armed Forces Exhibit will feature "procurement" both by showing what is needed, how it is used, and by staffing four desks with procurement personnel to serve you.

Registration is \$3.00—good for 4 days, sessions and show, both at Waldorf-Astoria Hotel and Grand Central Palace. (IRE)

**Radio Engineering Show**  
Grand Central Palace

**New York City**

267 Exhibits  
of Electronic  
Advances

**March 19-22 1951**

## Sensitive Rugged

## Dependable

### HEILAND GALVANOMETERS

of high current and voltage sensitivity are the heart of Heiland recorders.

Heiland galvanometers are available in natural frequencies ranging from 32 cycles per second to 4700 cycles per second. All galvanometers are electromagnetically damped with exception of those having natural frequencies above 450 cycles per second; these are fluid damped. Permanent magnet assemblies are available for mounting 2, 6, and 12 Heiland galvanometers.

dependable instruments

For further information on Heiland Galvanometers, Multi-Channel Oscillograph Recorders or Associate equipment, write or wire...

**HEILAND RESEARCH CORPORATION** 130 East 5th Ave. DENVER, COLO.

## New BIRTCHER TUBE CLAMP

### FOR MINIATURE TUBES

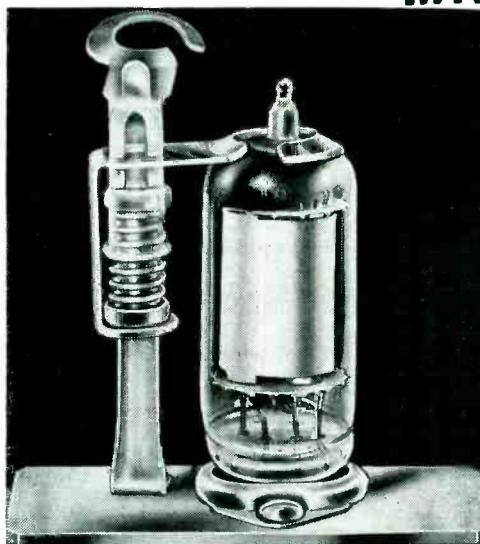

**POSITIVE PROTECTION  
AGAINST LATERAL AND  
VERTICAL SHOCK!**

The *New* Birtcher Type 2 Tube Clamp holds miniature tubes in their sockets under the most demanding conditions of vibration, impact and climate. Made of stainless steel and weighing less than 1/2 ounce, this *New* clamp for miniature tubes is easy to apply, sure in effect. The base is keyed to the chassis by a single machine screw or rivet...saving time in assembly and preventing rotation. There are no separate parts to drop or lose during assembly or during use. Birtcher Tube Clamp Type 2 is all one piece and requires no welding, brazing or soldering at any point.

If you use miniature tubes, protect them against lateral and vertical shock with the Birtcher Tube Clamp (Type 2). Write for sample and literature.

Builder of millions of stainless steel Locking Type Tube Clamps for hundreds of electronic manufacturers.

*The BIRTCHER Corporation*

5067 HUNTINGTON DRIVE • LOS ANGELES 32



# COAXWITCH

## COAXIAL SELECTOR SWITCH

CUT-A-WAY VIEW, MODEL 74

50 Ohms —  
Type N Connectors—Manually Controlled  
Low VSWR—4 Models

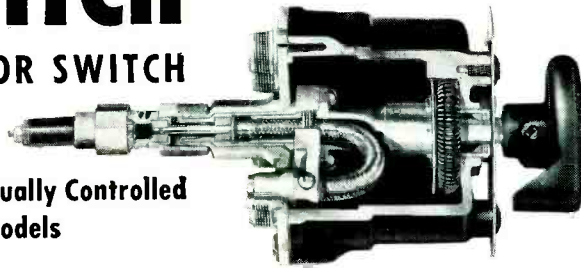

The COAXWITCH is an RF switch for use in coaxial circuits where it is important that the 50 OHM impedance of the cables be maintained. In a circuit sense, this switch consists of two pairs of "N" connectors spaced  $4\frac{1}{2}$ " apart using RG-8/U as the connecting link. The COAXWITCH itself introduces no VSWR other than that of connectors. Characteristic impedance is maintained thru all switch details. Cut-a-

way view shows that shield as well as center conductor is switched. Beryllium copper contacts, on the gooseneck, mate directly with male "N" (Type UG-21B/U) connectors, which connect directly to back plate of switch. Since all connectors come out in line with axis of switch, right angle connectors are usually unnecessary.

Literature Gladly Sent

<p>MODEL 74 SINGLE COAXIAL CIRCUIT SIX POSITIONS (SELECTOR OR TAP SWITCH)</p>	<p>MODEL 718 SINGLE COAXIAL CIRCUIT EIGHT POSITIONS (SELECTOR OR TAP SWITCH)</p>	<p>MODEL 72-2 TWO COAXIAL CIRCUITS TWO POSITIONS (SPOT, ETC.)</p>	<p>MODEL 72R TWO COAXIAL CIRCUITS REVERSING SWITCH (SPOT, ETC.)</p>
---	--	---	---

**BIRD ELECTRONIC CORP.**  
*Instrumentation for Coaxial Transmission*  
1800 East 38<sup>th</sup> Street • Cleveland 14, Ohio  
West Coast Representative • NEELY ENTERPRISES • Hollywood 46, Calif.

BACKTALK

(continued)

function to be sampled by  $1 + 2 \cos(\omega_s t + \theta)$  (if we neglect the higher-order terms which are not transmitted anyway), the sampled red low frequencies for example will be  $aR_L + 2aR_L \cos(\omega_s t + \theta_R)$ ; then, if we let  $aR_H + bG_H + cB_H$  equal the mixed highs, then the total signal as transmitted is  $aR_H + bG_H + cB_H + aR_L + bG_L + cB_L + 2a^1R_L \cos(\omega_s t + \theta_R) + 2b^1G_L \cos(\omega_s t + \theta_G) + 2c^1B_L \cos(\omega_s t + \theta_B)$ . It is obvious that the first part of this expression is a normal black and white signal containing the lows and highs. The second part is a phase and amplitude modulated subcarrier of angular frequency  $\omega$ , which constitutes the color information. In the RCA system as originally proposed, the  $a$ ,  $b$ , and  $c$  and the  $a^1$ ,  $b^1$ , and  $c^1$  are all equal and equal to  $1/3$ , and  $\theta_R$ ,  $\theta_G$ ,  $\theta_B$  are 0 deg, 120 deg and 240 deg. In the Hazeltine modification using asymmetrical sampling,  $a$ ,  $b$  and  $c$  are in such a proportion as to give a black and white signal with a brightness characteristic corresponding to that of the eye and  $a^1$ ,  $b^1$  and  $c^1$  and  $\theta_R$ ,  $\theta_G$  and  $\theta_B$  are so chosen as to have the desired transmission characteristic. This includes, among other things, that for a white signal the amplitude of the subcarrier should be zero, for instance.

The subcarrier frequency is so chosen as to cause the least amount of interference to the black and white part of the signal and from the black and white signal into the signal carried by the subcarrier. If we choose this frequency by looking at a kinescope and observing the dots caused by the carrier on the face of the tube we would choose the frequency so that these dots interlaced and call it dot-interlaced. If, on the other hand, we examined the frequency spectrum and interlaced the side bands, we would call it frequency-interlaced. However, the two are identical because every possible frequency-interlaced frequency will be dot-interlaced and vice versa.

Since the subcarrier in the RCA system is phase and amplitude modulated, we can say that we have two subcarriers one of which is phase modulated and the other amplitude

# ALLIED world's largest distributor of

# RCA ELECTRON TUBES FOR INDUSTRY

All types in stock

- Vacuum Power Tubes
- Thyratrons
- Vacuum & Gas Rect.
- Ignitrons
- Cold-Cathode Tubes
- Phototubes
- Oscillograph Tubes
- Camera Tubes
- Monoscopes
- Special Tubes

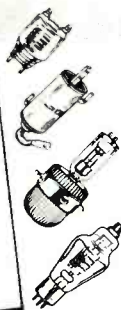

Quick, Expert Industrial Service

ALLIED maintains in stock for quick shipment the world's largest inventory of RCA special-purpose electron tubes—of all types. We specialize in supplying the tube needs of industrial, broadcast, governmental and other users. Shipments are made from stock to any part of the nation within hours after we receive your order. Save time, effort and money—fill all your tube needs from a single, dependable source.

FREE

Interchangeability Directory

Valuable guide to selection of proper RCA tube type replacements. Lists 1600 type designations, covering non-receiving electron tubes. Write for your FREE copy of RCA Guide No. 37-046.

REFER TO YOUR ALLIED CATALOG

Make ALLIED your central supply source for all electronic supplies—parts, tubes, test instruments, tools, audio amplifiers, accessories—available immediately from the world's largest stocks. Order from your ALLIED Catalog—the leading Electronic Buying Guide.

ALLIED RADIO

833 W. Jackson • Dept. 11-CC-1 • Chicago 7, Ill



Send for FREE 1951 CATALOG

Everything in Electronics from ONE Source

# LOW FREQUENCY RECEIVER

35 K.C. to 500 K.C.

Excellent Selectivity and Sensitivity

for  
Special Government and  
Commercial Communications Applications



**SENSITIVITY:** Exceeds 1 micro-volt over entire frequency range and on all antenna input impedances.

**SELECTIVITY:** Approximately one half of one percent of operating frequency over entire frequency range.

**ANTENNA INPUT IMPEDANCES:** 70 ohms and 600 ohms untuned and 300 ohms series tuned.

**REMOTE CONTROL PANEL:** Available for remote control of RF gain and BFO frequency.

**AUDIO OUTPUT:** 500 mw to 600 ohm balanced line.

Selection of AVC or MVC  
A. F. Gain Control

Primary Power Source: 115 v. or 230 v. 60 cycles

**FIXED FREQUENCY OPERATION  
PLUG-IN COIL SETS**

*Built to Rigid Government Specifications*

Available only in lots of 10 or more

Prices upon Application

**El-Tronics**  
INC.

2649 N. HOWARD STREET  
PHILADELPHIA 33, PA.

## MEMO TO DESIGNERS

THE PATH OF MOST RESISTANCE FOR ELECTRICITY  IS THE PATH OF LEAST RESISTANCE for your PURCHASING AGENT

## We're Talking About JELLIFF ALLOY 1000

This new resistance wire is almost too good to be true. Not only is the Resistivity 1000 ohms/cm (48% higher than that of the widely-used nickel-chromiums), but it also has such outstanding mechanical and electrical properties that it can easily replace several other alloys now being used in the smaller gages for precision resistors.



This means simplified procurement, stock and inventory procedures — more compact precision resistors — lower cost and longer life for the finished product.

For the full story of Alloy 1000, write for Bulletin 17



Standard • STANDARDIZE ON Standard • STANDARDIZE ON Standard





### Standard CRYSTALS Stand UP!

That's not just "sales talk" either. Years of research and experience in crystal manufacture are behind the special process we use to make STANDARD products stand up under shock and extreme temperature variations. Their range?—200 to 1200 kc. CT and DT cut. Hermetically sealed and dry nitrogen filled. Of course, they meet all Government Specifications.

*Write—wire—call for specific information or request Catalog E for complete details.*



## Standard Piezo COMPANY

CARLISLE, PENNSYLVANIA



Standard • STANDARDIZE ON Standard • STANDARDIZE ON Standard



Designed for



Application

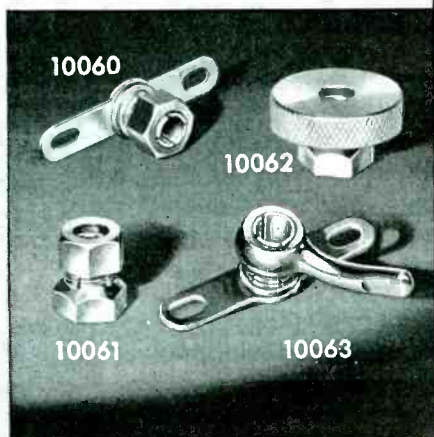

### SHAFT LOCKS

In addition to the original No. 10060 and No. 10061 "DESIGNED FOR APPLICATION" shaft locks, we can also furnish such variations as the No. 10062 and No. 10063 for easy thumb operation as illustrated above. All types are available in bright nickel finish to meet Signal Corps requirements or black oxide to meet Navy specifications.

**JAMES MILLEN  
MFG. CO., INC.**

MAIN OFFICE AND FACTORY  
**MALDEN  
MASSACHUSETTS**



BACKTALK

(continued)

modulated. The reason that we phase-modulate one is because we find that the two subcarriers must be the same frequency and this is the only way to separate the two modulations. The reason that they must be the same frequency is that if we have two frequencies both of which are interlaced frequencies, they will not be interlaced with respect to each other. (If one is  $(M + \frac{1}{2})$  times line frequency and the other is  $(N + \frac{1}{2})$  times line frequency, then the difference will be  $(M - N)$  times line frequency.) This difference frequency will show up on any black and white receiver, due to the detecting action of the non-linearity of the kinescope, as a series of coarse, stationary, vertical lines. (We were made very conscious of this effect during our cable tests where we had two modulated signals of different frequencies running in adjacent rooms, when we had to go quite great lengths to keep one from interfering with the other).

These three signal channels, that is, the main channel and the amplitude and phase of the subcarrier

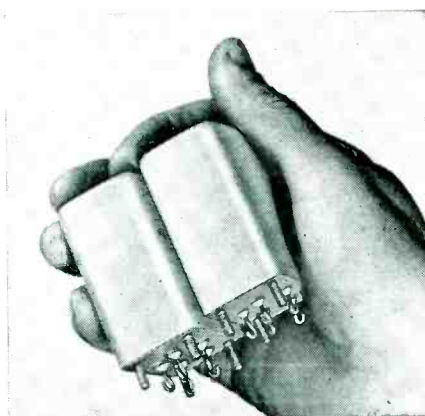

## 2 for 1

Two of these newly developed Acme Band Pass Wave Filters take up no more chassis space than formerly was required for one.

This is just another example of how Acme is solving the most difficult specialized problems. Your inquiry is invited.

**Acme  
ELECTRONICS**

Division of Acme Metal Die, Inc.  
212 E. 17th St., Los Angeles 15, Prospect 7457  
Wave Filters • Delay Lines • Magnetic Amplifiers • Special Transformers & Chokes • Toroidal, Universal & Solenoid Wound Inductors

# For plywood remember



## Keller will render complete service



Molded plywood seamless tubing for radar masts



Cabinet wrapper of curved molded plywood

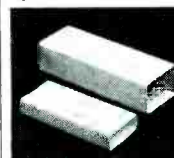

Coil forms of plastic impregnated cloth

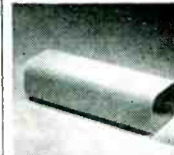

Electronic unit housing or container



Radome of low pressure plastic impregnated cloth

Keller designs, engineers and fabricates molded plywood

... from very light to heavy gauge shapes in nearly any practical size, gauge and veneer.

Metal shortage problems have been solved with molded plywood — In the electronics field Keller renders many services . . . to name a few:

- Curved plywood cabinet panels and structural chassis members.
- Lead plywood in X-Ray and Atomic shielding.
- Plywood tubing for masts, rods and antennae.
- Low pressure Plastics reinforcing fibre glass, glasscloth and mats.

Write, wire or phone Keller with your problems.



**Keller  
PRODUCTS, INC.**

38 Union Street  
Manchester, N. H.

# CIVIL DEFENSE ANTENNAS

Plan to utilize amateur operators and the newly assigned amateur Civil Defense frequencies in your most important communications.

We can supply Premax BXC or BXS center-loaded Antennas for mobile installations—special antennas for VHF—and, when you plan the permanent base station, the Premax 35' vertical or the 17' center-loaded Marine Antenna gives ideal service.

Send for Premax Catalog and let us show you the type of antenna equipment around which you can build your CD Emergency System.

**PREMAX PRODUCTS**  
DIVISION CHISHOLM-RYDER CO., INC.

5101 Highland Ave. Niagara Falls, N. Y.

## STAY ON THE AIR WHEN POWER FAILS...with an ONAN Electric Plant



**AUTOMATIC START & STOP**

Model 10EL, 10KW A.C.

When storms, floods, or fires interrupt electricity and force you off the air, you lose listeners and income. Guard against loss, assure vital public service during emergencies by installing an Onan Electric Plant. Onan Standby Electric plants serve many network and private stations. Automatic models to 35,000 watts.

**PORTABLE ELECTRIC PLANTS FOR MOBILE RADIO USES**  
Supply A.C. power for broadcasting at scene of events. Can be carried by hand or in trunk of car. Weigh as little as 80 pounds. A.C. models 350 to 35,000 watts.

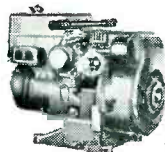

Write for **FREE Folder**



**D. W. ONAN & SONS INC.**  
7020 University S. E.  
Minneapolis 4, Minnesota

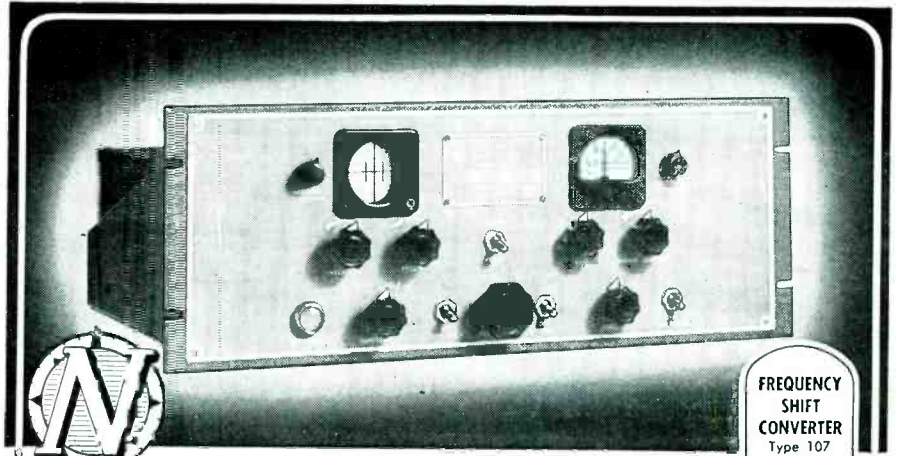

**FREQUENCY SHIFT CONVERTER**  
Type 107  
Model 2

### BIGGEST PERFORMANCE—Smallest Size

Four exclusives are yours with the Northern Radio FREQUENCY SHIFT CONVERTER—utmost simplicity of operation, precision tuning, highest quality performance, and smallest size in the industry.

For single and diversity FS receiving systems, this dual channel unit converts mark and space tones into DC pulses, and drives teleprinters and other recorders directly. Its unique 2" oscilloscope provides the industry's most meaningful tuning pattern for precise receiver adjustment—during initial setup and while keying. Its specially designed limiter and discriminator afford an exceptionally high degree of performance. Polar or neutral output is available. Keying speeds up to 600 w.p.m. It's only 15" wide x 7" high x 15" deep.

This unit may also be used as a make and break CW or ICW demodulator.

See the specifications on this outstanding model in the 1950 Electronics Buyers Guide. For complete data on the precision-built Northern Radio line, write today for your free latest Catalog E-3.

**NORTHERN RADIO COMPANY, inc.** 143-145 West 22nd Street  
New York 11, N. Y.

Price-Setters in Quality Communication Equipment

## NOW! BECOME EXPERT AT Radio-Television

**IN 4 EASY STEPS!**

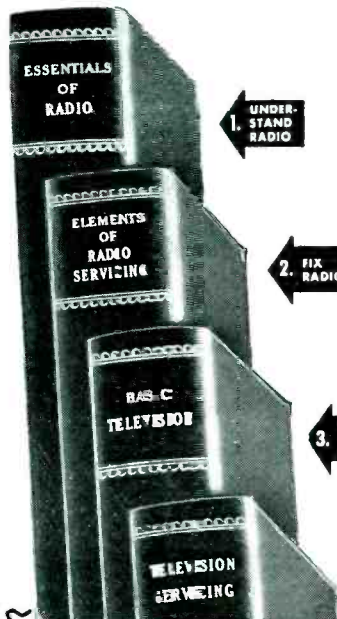

1. UNDER-  
STAND  
RADIO

2. FIX  
RADIO

3. UNDER-  
STAND  
TV

4. FIX  
TV

**Complete Self-Training Course in RADIO and TELEVISION**  
Prepared by Famous Experts—Starts From Scratch. Takes You BY SIMPLE LOGICAL STEPS From Basic Theory to Advanced Problems of Repair, Installation, Color TV, etc.

NOW you can do ANY Radio-TV installation, service, or repair job like an expert; operate field-testing equipment; understand problems of TV broadcasting, FM-AM transmission, etc. You can step into a good-paying job—or start your own service business. And you can train yourself for your career AT HOME . . . IN YOUR SPARE TIME . . . with the McGraw-Hill Basic Course in Radio and TV.

**2296 Pages—1611 Illustrations**

The men who wrote this complete 4-volume course are among the outstanding radio and TV instructors in America today. They are practical, shirt-sleeved technicians. They know the questions you want answered. Every detail is clearly ex-

plained in over TWO THOUSAND PAGES of step-by-step instruction and over SIXTEEN HUNDRED "how-to-do-it" illustrations, cross-section diagrams, etc. The review questions and answers "nail down" everything you learn. At-a-glance "trouble-shooting" charts show how to diagnose instantly any radio or TV breakdown . . . and how to repair it expertly and quickly.

The course will pay for itself many times over. It can qualify a beginner for FCC's 1st-Class License test; gives an experienced technician more confidence, shows him new tricks.

**Send No Money**

Mail coupon below to examine this complete four-volume course FREE for 10 days; then while you use it, send small monthly installments until the price of \$19.95 is paid.

These 4 books can help you qualify for FCC's New FM, TV 1st Class License Test.

ESSENTIALS OF RA- DIO, 800 pages, 433 illus. BASIC TELEVISION, 592 pages, 415 illus.  
ELEMENTS OF RADIO TELEVISION SERVICING, 475 pages, 375 illus. TV, 429 pages, 388 illus.

**FREE 10 DAY TRIAL COUPON**

McGRAW-HILL BOOK COMPANY, Inc.,  
330 W. 42nd St., New York 18

Send me McGraw-Hill's Basic Course in Radio & TV, 4 volumes, for 10 days' examination on approval. If the books prove satisfactory, I will remit \$1.95 in 10 days, and \$3.00 monthly until \$19.95 is paid. Otherwise I will return books postpaid.

Name .....

Address .....

City ..... Zone ..... State .....

Company .....

Position ..... L-3-51

This offer applies to U.S. only.



# MU METAL SHIELDS

FOR MILITARY AND COMMERCIAL APPLICATIONS

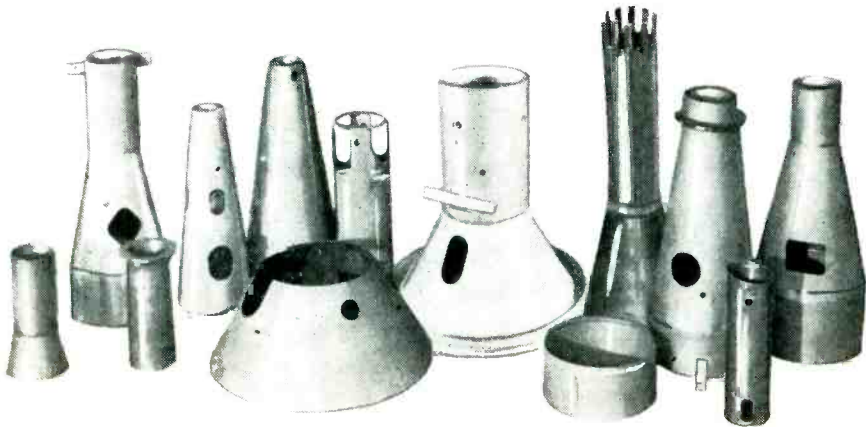

Specializing in precision sheet metal fabrication, Multi-Metal produces components to exacting specifications.

Our engineering staff can help solve design and production problems. Your inquiries will receive prompt attention.

**Multi-Metal Co.** 1350 Garrison Ave.  
New York 59, N. Y.

MIL - JAN - AN - C - CCC - MIL - JAN - AN - C - MIL -  
AN - C - MIL -  
AN - C - MIL -  
JAN - AN - C -  
JAN - AN - C -  
JAN - AN - C -  
JAN - AN - C -  
MIL - JAN - AN - C -

**A VITAL TESTING SERVICE FOR GOVERNMENT SUPPLIERS**

The specifications of most Government contracts make it advisable to pre-test components and related equipment before submitting to Government test. We offer Government suppliers testing programs in the following Environmental and Functional Testing Fields, designed to meet official contract specifications:

- **VIBRATION** (Standard High Frequency)
- **SALT SPRAY** (Corrosion)
- **FUNGUS**
- **HUMIDITY** (Varying Condition)
- **SAND & DUST**
- **LOW PRESSURE** (Altitude Testing)
- **HIGH & LOW TEMPERATURE**

Write or call, and we will arrange technical discussions without obligation.

**UNITED STATES TESTING COMPANY, INC.**  
Established 1880  
HOBOKEN, NEW JERSEY

PHILADELPHIA · BOSTON · WOONSOCKET · CHICAGO · NEW YORK · LOS ANGELES · DENVER · MEMPHIS

Member of American Council of Commercial Laboratories

MIL - JAN - AN - C - CCC - MIL - JAN - AN - C - CCC -  
AN - C - CCC - MIL - JAN - AN - C - CCC -

BACKTALK (continued)  
could of course carry any three signals from which a color picture can be derived. They might, for instance, carry the red, blue and green signals, or they might carry the brightness and the red and blue signals, or the brightness and  $x$  and  $y$ . In the RCA system they are the brightness, chroma and hue where the chroma is the amplitude and the hue is the phase of the subcarrier. We may make a polar plot of phase angle versus dominant wavelength and get a locus of points similar to the color triangle.

It will be seen then that in the transmission we no longer have a tri-color signal, and this is perhaps what you meant, but it is still simultaneous; that is, the three components exist together simultaneously.

It doesn't matter how the signal is obtained so long as it gives this relation between phase and dominant wavelength. It can be obtained, as we obtain it at present, by modulating three sine waves of appropriate phase by the red, blue and green signals, or by modulating two (sine and cosine) with the

**MERCOID**  
MERCURY SWITCHES  
BUILT TO ENDURE

MAGNET TYPE      TILTING TYPE      LIGHT ACTUATED TYPE

Universally Known for Their Superior Quality and Workmanship

They are not affected by dust, dirt or corrosion and have many definite applications where open contacts are not suitable. Various types available. MERCOID is your guarantee of the best in mercury switches. Further information sent upon request.

Our engineering department will gladly assist you on any of your switch problems.

THE MERCOID CORPORATION  
4223 West Belmont Avenue, Chicago 41, Illinois

IT PAYS TO GET THE BEST

TR-1  
**PUMPING SYSTEM**

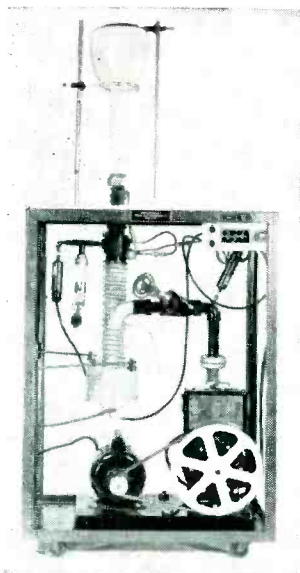

Suitable for research or pilot plant on any type tube. Others available built to specification.

Also . . .

- OIL DIFFUSION PUMPS
- VACUUM EVAPORATING UNITS
- EVAPORATED FILMS (All Types)

**OPTICAL FILM ENGINEERING CO.**  
2125-J Cherry St. Philadelphia 3, Pa.

# ALUMINUM FABRICATION

FOR MILITARY AND COMMERCIAL APPLICATIONS

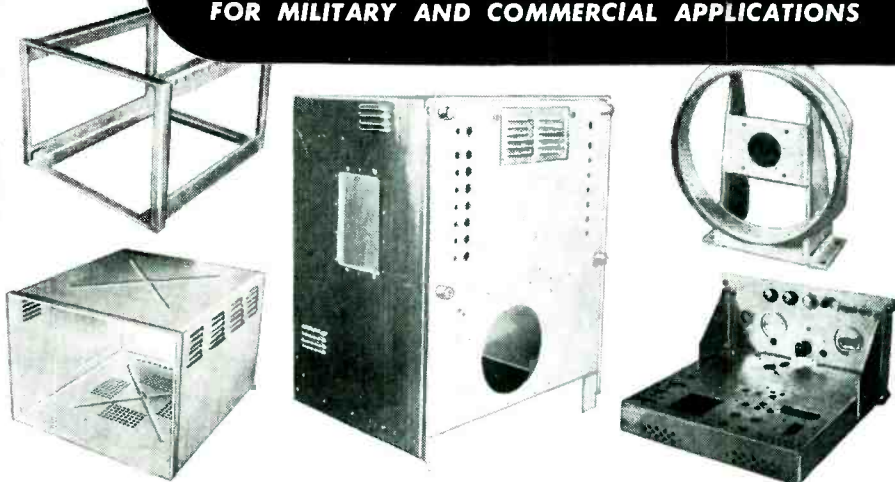

Complete Aluminum fabrication facilities include Heliarc welding and Sciaky spotwelding equipment.

Multi-Metal specializes in precision sheet metal fabrication to rigid specifications, in all metals including: Aluminum, Carbon Steel, Copper, MuMetal, Stainless Steel, etc.

Our engineering design staff is at the service of our customers. Send prints and specifications for prompt attention.

**Multi-Metal Co.** 1350 Garrison Ave. New York 59, N. Y.

## Lavite STEATITE CERAMIC

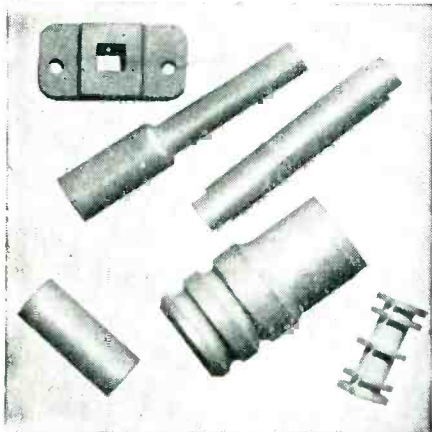

Design engineers and manufacturers in the radio, electrical and electronic fields are finding in LAVITE the precise qualities called for in their specifications . . . high compressive and dielectric strength, low moisture absorption and resistance to rot, fumes, acids, and high heat. The exceedingly low loss-factor of LAVITE plus its excellent workability makes it ideal for all high frequency applications.

Complete details on request

**D. M. STEWARD MFG. COMPANY**

Main Office & Works: Chatham, Mass.  
Branches: Northham, Mass. • Chicago • Los Angeles  
New York • Philadelphia

## COMPOUNDS

Scientifically compounded for specific applications from waxes, resins, asphalts, pitches, oils, and minerals. Available in wide range of melting points and hardnesses. Special potting compounds are heat conducting and crack resistant at extremely low temperatures. Recommendations, specific data, and samples will be furnished on request.

for

### IMPREGNATING

radio coils  
transformer coils  
ignition coils  
wire coverings  
paper tubes and forms  
porous ceramics

### DIPPING

Coils  
Transformers  
Condensers

### SEALING

condensers  
batteries  
switch base terminals  
socket terminals  
light fixtures

### POTTING

Radio Transformers  
Light Units  
Loading Coils  
Condensers



**BIWAX CORPORATION**

3445 HOWARD STREET  
SKOKIE, ILLINOIS

*"Precision first!"*

*says famous instrument manufacturer*

*. . . specifies Bird Jewel Bearings*

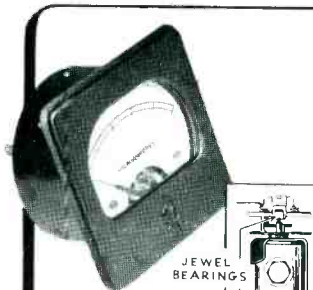

JEWEL BEARINGS

Almost invisible to the naked eye — yet precision depends on these quality controlled Bird Bearings

Microampere Meters from this leading manufacturer\* are world famous for top precision — owe much credit to quality construction that includes Bird Jewel Bearings. Two precision-made jewels — used as bearings for armature — assure smooth response . . . guarantee a lifetime of accurate operation.

Discover how Bird Jewel Bearings can solve your miniature bearing problems with unset or set assemblies to suit your requirements — write for information.

\*Name on request

*Richard H. Bird & Co., Inc.*

1 Spruce Street, Waltham 54, Mass.

Mfrs. of glass and sapphire jewel bearings for instruments, dials and gauges of all types



**EXTRA!**

**ATR**

**"A" BATTERY ELIMINATORS**

*Makes it easy to DEMONSTRATE AND TEST D.C. APPARATUS FROM A.C. LINES*



**for DEMONSTRATING AND TESTING AUTO RADIOS**

New Models . . . Designed for testing D. C. Electrical Apparatus on Regular A. C. Lines. Equipped with Full-Wave Dry Disc Type Rectifier, Assuring Noise-less, Interference-Free Operation and Extreme Long Life and Reliability.

**NEW MODELS** **NEW DESIGNS**  
**NEW LITERATURE**

"A" Battery Eliminator, DC-AC Inverters, Auto Radio Vibrators

**ATR** See your jobber or write factory

**AMERICAN TELEVISION & RADIO CO.**  
Quality Products Since 1935  
SAINT PAUL 1, MINNESOTA—U. S. A.

BACKTALK

(continued)

proper two signals derived from the three, or by modulating with any three signals from an infinite number of primaries which by linear transformation can give the desired primaries so long as the angles and amplitudes into the three modulators are correctly chosen. One very useful such combination is that in which one of the signals is derived from a tube having the eye characteristic, so that this same signal can be used as the brightness signal.

At the receiver, likewise, the exact primaries do not matter because the proper signal for any set of primaries can be derived from the received signal, even, for instance, if the receiver had a reproducing system using subtractive primaries. The three signals are derived by simple combination of the brightness signal and the output of three properly phased modulators; or again, by a combination of the brightness signal and the output of two (sine and cosine) modulators.

It will be noticed again that the signals that are applied to the three

**ANGULAR ACCELEROMETERS**

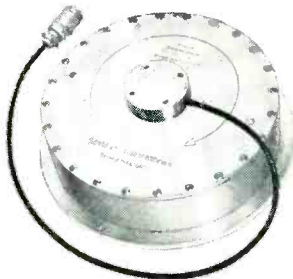

A new series of unbonded strain gage angular accelerometer is available to detect and measure angular acceleration in ranges from  $\pm 3$  to  $\pm 400$  radians/sec/sec. The design of these instruments permits close balance against linear acceleration effects and excellent resolution while providing greatly increased resistance to destruction by linear acceleration. In these instruments, the suspended mass weighs but a few grams.

In corresponding, may we suggest that you be as specific as possible in outlining range and frequency requirements so that we may offer detailed recommendations in our reply.

Please write our engineering department for specific data.

**SL**  
**STATHAM LABORATORIES** SCIENTIFIC INSTRUMENT

9328 SANTA MONICA BLVD.  
BEVERLY HILLS, CALIF.

**WIND more COILS faster**

**WITH YOUR PRESENT COIL-WINDING MACHINE!**

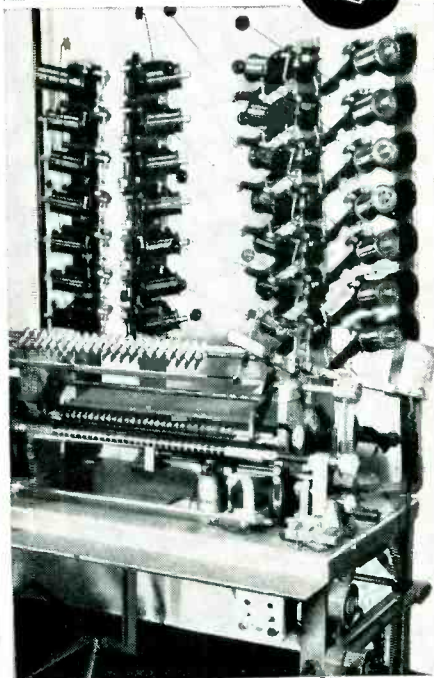

— USE **PAMARCO** Wire DeReeling Tensions for PERFECT COILS

Installation of these inexpensive PAMARCO tensions lowers winding costs because each machine will accommodate more coils at higher winding speeds. In addition to increased production, PAMARCO tensions raise production quality. Free-running action practically eliminates wire breakage and shorted turns. Simple thumb screw setting quickly adjusts for any wire gauge. No tools or special skill are needed for operation. For complete data call or write.



**PAPER MACHINERY & RESEARCH, INC.**

1014 OAK STREET  
ROSELLE, NEW JERSEY

# SYLVANIA ELECTRIC

Consistent  
Earner in  
WAR and  
PEACE

Founded just 50 years ago, Sylvania Electric Products, Inc. today represents a strongly entrenched operation in several fast-growing electronics markets. The company's major products are of equal importance in both peace and war. Military production presents relatively few conversion problems.

We have prepared a detailed Analysis of this company, whose stock appears attractive for long-term appreciation and income. Investors may obtain copies without obligation by writing on their personal or business letterhead. Please ask for Bulletin No. 11.

## PAYNE, WEBBER, JACKSON & CURTIS

Established 1879

Members New York Stock Exchange and other  
principal stock and commodity exchanges

25 BROAD STREET, NEW YORK, N. Y.

Uptown Office: 745 FIFTH AVENUE

BOSTON

CHICAGO

OFFICES FROM COAST TO COAST

For Precision Washers... For Precision Stampings...



## WHITEHEAD STAMPING CO.

A preferred source of precision-made WASHERS and STAMPINGS. 46 years of experience and up-to-the-minute facilities, assure highest quality and service.



EST.  
1903

**WHITEHEAD STAMPING CO.**

1691 W. Lafayette Blvd.

Detroit 16, Michigan

### Little thought-of facts about capacitors

The short time breakdown voltage of a well-made D.C. capacitor is not less than 5 to 6 times the actual working voltage at 20°—

$E = 5 \times e \text{ min}$   
E = Breakdown voltage  
e = Rated d.c. working voltage

INDUSTRIAL CAPACITORS are unvaryingly held to this formula.

Designed for maximum safety and the smallest possible volume, INDUSTRIAL CAPACITORS are the most widely used capacitor in industrial applications.

WRITE TODAY FOR DETAILED CATALOG

**INDUSTRIAL CONDENSER CORP.**

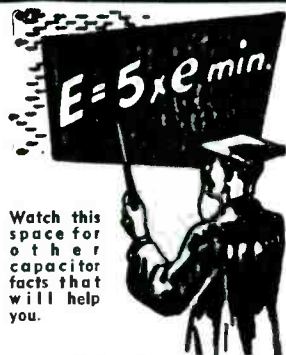

Watch this space for other capacitor facts that will help you.

Sales Offices In  
All Principal Cities  
3243 N. California Ave.  
Chicago 18, Illinois



PRECISION  
ELECTRONIC  
SYSTEMS

### RADIO

- Direction Finder  
Electronic Goniometer  
CRD-2
- Signal Generator  
Crystal Control  
150 kc. to 150 mc.
- Spectrum Generator  
Marker Pulses  
.5 to 50mc.

### CONTROLS

- Servoscope
- Servoboard
- Servotherm
- System Synthesis
- Reluctance  
Amplifiers
- Radiation  
Detectors

AS EXHIBITED AT THE  
Radio Engineering Show  
Grand Central Palace

New  
York  
City

Booth  
348

March 19-22 1951

Write today for  
complete information

**SERVO**  
CORPORATION  
OF AMERICA  
NEW HYDE PARK, N. Y.



# MICROPOT

PRECISION TEN-TURN POTENTIOMETER

1. You get permanent accuracy because the resistance wire is locked in place. It is precision positioned and moulded integrally with the housing.
2. You get permanently accurate settings, smooth action and low uniform torque provided by the stainless steel, precision ground, double thread lead screw guiding the moving contact.
3. You get precise positioning of the moving contact because of the two bearings supporting the rotor assembly.
4. You get good rigid terminals because they are moulded integrally with the housing.
5. Terminals soldered to ends of resistance element before moulding. Entire resistance circuit is an integral part of the housing.
6. You get accurate setting and re-setting due to anti-backlash spring in contact guide.
7. You get a fine resolution because of the  $43\frac{1}{2}$ " length of resistance wire in the spiral element.
8. You get a resistance output directly proportional to shaft rotation within  $\pm 0.1\%$  of the total resistance. Every potentiometer is automatically machine tested for linearity at 101 points.

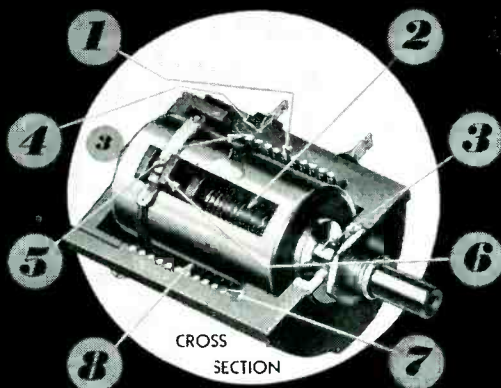

**LINEARITY  
ACCURACY  $\pm 0.1\%$**

Units for immediate shipment:  
1,000 to 30,000 ohm range.  
Special resistance values made to order.

WRITE TODAY FOR  
ENGINEERING INFORMATION

GIBBS DIVISION

**THE GEORGE W. BORG CORPORATION**  
DELAVAN • WISCONSIN



BACKTALK

(continued)

guns of the kinescope at the receiver are continuous simultaneous signals which have color information up to half the subcarrier frequency.

ALFRED C. SCHROEDER  
Huntington Valley  
Pennsylvania

## Photoelectric Neon Diodes

DEAR SIRs:

I HAVE READ with interest the article by Irving Gottlieb entitled "Novel Application for Neon Diodes" in the January, 1951, issue of *ELECTRONICS*.

The photoelectric action of neon bulbs was pointed out in my article in the August 1948 issue of *Radio Electronics* (page 52). Since then many such articles have appeared along the same lines which leads one to suspect that commercial application may be expected in the near future. I do not believe that my observations of this effect were the first although they may have been as far as the neon bulb is concerned. The famous experiment

**NEW!** FREQUENCY AND TIME MEASUREMENTS  
ACCURATELY . . . CONVENIENTLY!

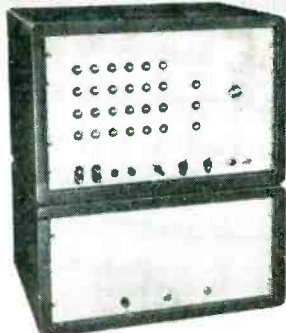

Model 801

by **Potter**

Now, the Potter Instrument Company offers all in one equipment, the features heretofore available only in separate counting systems. Two complete counting channels, a 100 kc crystal oscillator time base and unique gating circuits are combined to provide the new FREQUENCY-TIME COUNTER.

-using  $f = \frac{N}{t}$

ANY FACTOR  
MAY BE  
MEASURED  
FOR FIXED  
VALUE OF  
THE OTHER

### Universal 6-in-One MEGACYCLE FREQUENCY-TIME COUNTER

FREQUENCY MEASUREMENTS	0 to 1 mc range by counting cycles per pre-selected time or by measuring time per pre-selected count. Accuracy 0.001% minimum.
TIME INTERVAL MEASUREMENTS	0 to 10 seconds $\pm 10$ micro-seconds.
FREQUENCY RATIO MEASUREMENTS	Ratio of two external frequencies can be measured.
SECONDARY FREQUENCY	100 kc crystal oscillator with divided frequencies available at 10, 1 kc and 100, 10, 1 cps.
TOTALIZING COUNTER	Six decades, pulses 0 to 1 mc, sine wave 10 cps to 1 mc.
DIRECT RPM READING TACHOMETER	Through the use of an external 60 count per revolution photoelectric disc generator an accuracy of $\pm 1$ rpm is obtained.

Address inquiries to Dept. 6X or see us at the IRE Show—Booth 135



**POTTER INSTRUMENT COMPANY**  
INCORPORATED  
115 CUTTER MILL RD., GREAT-NECK, NEW YORK

Now Available  
**JUELITE PLASTIC  
RODS & SHEETS**

*Especially Formulated  
For Electronic Use*

- Dielectric qualities superior
- Coefficient of expansion comparable to glass and platinum
- Easily machinable
- Electrical, chemical, mechanical properties custom-formulated to meet specific requirements.
- Currently being used by many leading electronic manufacturers.

Write today for Technical Bulletin

**JUEL CORPORATION**

Manufacturing Chemists—  
Laminators—Casters

Plants: Arcadia, California  
General Offices: 333 N. Santa Anita Ave.  
Arcadia, California

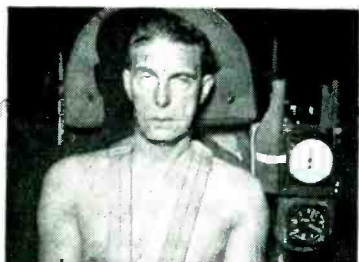

## beyond the **BLACKOUT**

● Giannini precision Accelerometers give faithful indication of the values of gravity beyond the range of human endurance. Giannini Accelerometers are precision-built for a variety of exacting applications in all fields of aircraft and industry. Write for catalog and engineering data.

G. M. Giannini & Co., Inc.  
Pasadena 1, California  
Springfield, New Jersey



# giannini

## ELECTRONICALLY REGULATED LABORATORY POWER SUPPLIES



BENCH  
MODEL 25

• STABLE  
• DEPENDABLE  
• MODERATELY PRICED

- **INPUT:** 105 to 125 VAC, 50-60 cy
- **OUTPUT #1:** 200 to 325 Volts DC at 100 ma regulated
- **OUTPUT #2:** 6.3 Volts AC CT at 3A unregulated
- **RIPPLE OUTPUT:** Less than 10 millivolts rms

WIDTH 14"  
DEPTH 6"  
HEIGHT 8"  
WT: 17 LBS.

For complete information write for Bulletin E



**LAMBDA ELECTRONICS**  
CORPORATION  
CORONA NEW YORK

# MICRODIAL

TEN TURN-COUNTING DIAL

Microdial is composed of two concentrically mounted dials... one for counting increments of each turn and the other for counting turns. The incremental-dial has 100 equal divisions and is attached rigidly to the shaft so there is no backlash. Thus the contact position is indicated to an indexed accuracy of 1 part in 1000. Rotation is continuous in either direction. There are no stops on the Microdial assembly.

**COMPACT...** Microdial has same O.D. as Micropot... requires no more panel space.

**CLEAR READING...** Forced fast-reading tests showed only 1/20th as many errors with Microdial open window as with next most legible dial. Turn counter distinguishes between 0 and 10 turn readings, and accelerates to avoid confusion on readings near integral turns. Precise readings are made from larger dial with maximum separation of graduations and wide angle visibility.

**CONVENIENT...** delivered completely assembled with dials synchronized. Easily mounted in a few seconds. All dials may be locked.

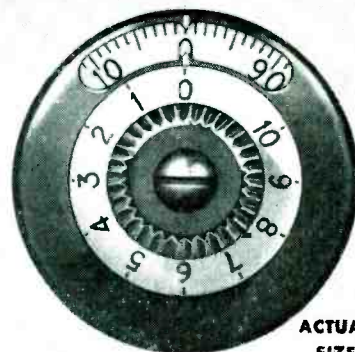

ACTUAL  
SIZE

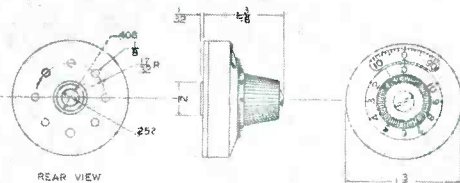

Microdial... turn-counting dial, primarily designed for use on Micropot ten turn linear potentiometers... use it on any multiturn device having ten turns or less.



GIBBS DIVISION

**THE GEORGE W. BORG CORPORATION**  
DELANA WISCONSIN



## The Key to SUBMINIATURE TRANSFORMER PROBLEMS

**DIMENSIONS:** 7/16" x 3/4" x 5/8"

**WEIGHT:** Less than 1/3 of an ounce

**TYPES:** input, interstage, output, reactor

These transformers fit into the smallest Mil-T-27 Case A.F.

Prompt Engineering Attention  
To Your Subminiature Problems

**UNION ELECTRIC PRODUCTS CO.**  
24 EDISON PLACE NEWARK 2, N. J.

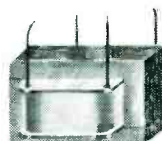

## LEADERS in COIL WINDING EQUIPMENT

**MACHINES FOR PRODUCTION  
AND LABORATORY USE**

**MOTORS • SPEED CONTROLS  
• GEARS • CAMS • TENSIONS**  
And All Necessary Related  
Equipment for Coil Winding

Model W

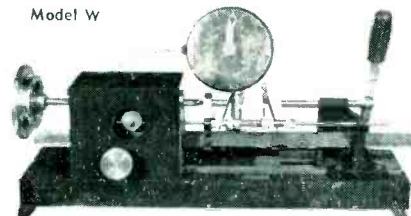

For actual demonstration of this and other models visit our booth #355 at the IRE Show March 19th to 22nd.

*Coil Winding Equipment Co.*  
37 W. MAIN ST. OYSTER BAY N. Y. TELE. OYSTER BAY 6-1285



**Try Remler for Service-Tested  
"Hard-to-Get" Components**

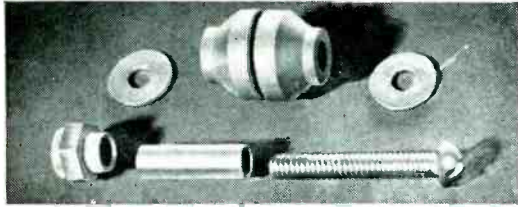

**SILASTIC RUBBER SHOCK MOUNTS**

① Ideal for sub-panel mounting. Isolates tubes from shock and vibration. Mount retains compliance from *minus 70° to plus 480°F*. Invaluable for military and airborne equipment.



**MINIATURE TUBE CLAMP**

② Corrosion resistant. Holds miniatures in sockets under severe conditions of shock and vibration without restricting air circulation. Easy to insert and withdraw tubes. Three sizes.

Remler Company Ltd.  
2101 Bryant St. San Francisco 10, Calif.

*Custom Components*

Metal-plastic components designed and manufactured to order. Write for quotations specifying electrical and mechanical characteristics. Describe application. No obligation.

*Remler*

Since 1918 PIONEERS IN ELECTRONICS AND PLASTICS

**THE NEW  
6T-4**



PRECISION STROBOSCOPIC  
FREQUENCY METER

MEASURES FREQUENCIES  
**INSTANTLY**  
BY PURELY VISUAL MEANS!



**ACCURATE TO 0.05%**

**FILL IN AND MAIL TODAY  
for FREE Literature**  
C. G. CONN Ltd.  
Electronics Division, Elkhart, Ind.  
Department 312

Send me descriptive literature on  
NEW 6T-4 STROBOCONN.

Name \_\_\_\_\_  
Street \_\_\_\_\_  
City \_\_\_\_\_ State \_\_\_\_\_

Measures transient vibrations. Finds precise speed of rotating mechanical parts. Calibrates or checks precision tachometers, oscillators, other pulse generators. Used in place of bridge methods in measuring inductance and capacitance. Many other uses.

**MAIL COUPON FOR COMPLETE  
INFORMATION... SEE HOW  
STROBOCONN CAN HELP YOU!**

BACKTALK

(continued)

by Prof. Hertz showing the photoelectric action of ultra violet light on spark gaps is perhaps the original.

You may be interested in some experiments made in 1945 on using the gaseous filled lamps as d-c generators. Many lamps were tested, but the best of any was an ordinary fluorescent lamp. This lamp was energized by the output of a radar set (about 100 kw pulse). The voltage developed across the two filaments being of low current was measured on a 20,000 ohms per volt meter. Readings as high as 60 volts d-c were obtained in this manner.

It is hoped that this small contribution of added information on this subject will be of interest to some of your readers.

HAROLD PALLATZ  
Precise Measurements Co.  
Brooklyn, New York

**Electronic Quiz**

THIS MONTH'S puzzler is submitted by Ken Maxwell, Chief Engineer,

**A BETTER ENGRAVER**

AT LOWER  
COST

The 2 and  
3-Dimensional

**MICO**



Fills the long-felt need for a portable, inexpensive and dependably accurate machine for making small dies, molds, templates, etc. Extremely simple to operate.

Note These Superior Features

- Engraves 2 or 3 dimensions.
- Pantograph permits 4 reduction ratios.
- Micrometric depth control graduated in thousandths of an inch.
- Entire spindle assembly removable to facilitate cutter grinding.
- Rugged cast iron construction with exclusive adjustments for insuring quick, accurate setting.

Send for complete specifications and attractive price list.

**MICO INSTRUMENT CO.**  
76E Trowbridge Street Cambridge, Mass.

*Specify...*



D'ARSONVAL PORTABLE  
**GALVANOMETERS**  
AND MOVEMENTS...



*New!*

Series 570-600  
Pointer-Type  
D-C Galvanometer

Here is a new addition to the line of G-M galvanometers. It is a completely assembled unit featuring an Alnico magnet for greater stability of calibration and a new high in sensitivity. Easily installed and replaced, requires only 2 3/4" below the mounting surface. Rugged construction throughout. Three models, with sensitivities per mm. division of .06, 0.10 and 0.20 microamps.

Write for specifications and prices on these and other galvanometers



LABORATORIES, INC.

4336 N. Knox Ave.

Chicago 41, Ill.

The one-piece, all-metal FLEXLOC is both a Stop and a Lock-Nut, due to its resilient segments which lock *positively* anywhere on a threaded member... even under extreme vibration.

Torque is unusually uniform and kept within a few inch pounds. 550° F. temperature has no terrors for the all-metal FLEXLOC. The FLEXLOC design is very adaptable as evidenced by a steadily increasing number of highly unorthodox applications. "Thin" and "Regular" types; NC and NF threads. Officially approved by many U. S. departments, bureaus, etc.

For further information, write for  
Bulletin 619-A

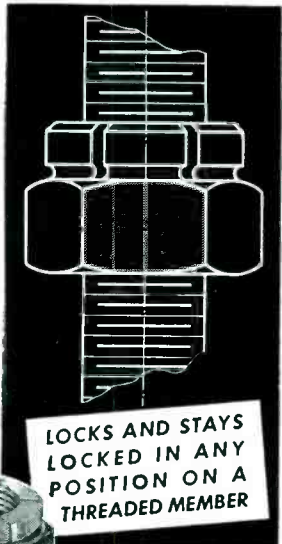

LOCKS AND STAYS  
LOCKED IN ANY  
POSITION ON A  
THREADED MEMBER

**FLEXLOC**

SELF-LOCKING NUTS

**-SPS** STANDARD PRESSED STEEL CO.  
JENKINTOWN 10, PENNSYLVANIA



*Quality—Specialty*  
**TRANSFORMERS**

For years we have supplied leaders of the Electronic and Electrical industries with superior specialty transformers.

Let us quote on your special commercial and military requirements.

A reliable source since  
1941

Write us today—or  
telephone Granite-4-8000

**AIRDESIGN, INC.**

241 Fairfield Avenue  
Upper Darby 2, Pa.

**SUB MINIATURE  
SLIP RINGS**

For

Gyroscopes • Computers • Pots  
Recording Instruments • Sights

Only .070 inch diameter for 6 ring assembly. Silver rings and leads hard coated, highly polished. Also with end ball bearing and housing.

**ELECTRO DEVELOPMENT  
CORPORATION**

6014 W. Washington Blvd.  
Culver City, Calif.

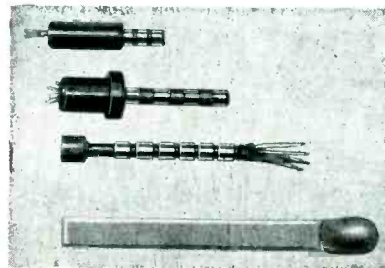

An Accredited Technical Institute  
Pioneer in Radio Engineering  
Instruction Since 1927

**CAPITOL RADIO  
ENGINEERING  
INSTITUTE**

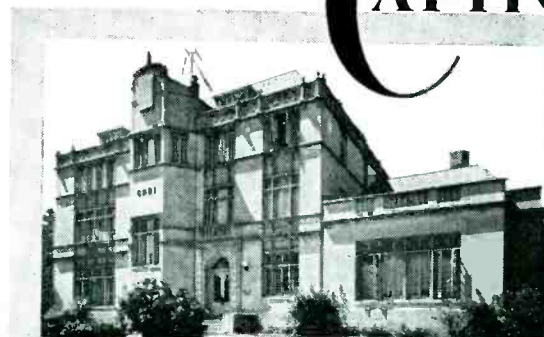

● Advanced Home Study and Residence Courses in Practical Radio-Electronics and Television Engineering.

Residence Courses approved for Veteran Training

● Request your free home study or residence school catalog by writing to Dept. 283C.

16th & Park Road, N.W., Washington 10, D.C.



The leaders specify  
*Tensolite*

Leading engineers specify TENSOLITE Miniature Wire and Cable because— miniaturization programs demand less weight, less space and greater flexibility. Only TENSOLITE is devoted exclusively to this field — assuring you of faster service, lower cost, supreme quality, advanced design and know-how, and specialized facilities.

for **MINIATURE FLEXIBLE INSULATED WIRE and CABLE**

Stranded Copper Wires (#40 to #20) and Special Tinsel Cordage

**CABLES (Multi-Conductor) TWISTED — PARALLEL — BRAIDED SHIELDS**

BARE COPPER — TINNED COPPER SILVER PLATED

**OVER-BRAIDS COTTON — NYLON — PLASTIC\***

\*TENSOLITE'S exclusive plastic film-covered Fiberglas

**SHIELDED CABLE**

(Produced under Tensolite Patents)

A new construction produced by TENSOLITE to meet extremely rigid requirements of a confidential government research project. Tensolite experience and exclusive patented methods of manufacture produced the product illustrated which was tested and approved for incorporation in the design.

**SUPER FLEXIBLE 4 CONDUCTOR CODE NO. 2165 1-4**

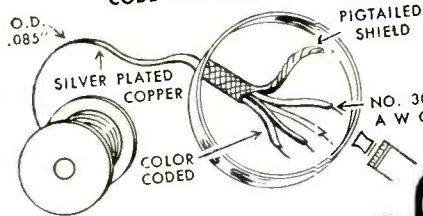

TENSOLITE'S versatile patented process is uniquely suited to economical production of unlimited special constructions within its field. Wire sample and literature sent without obligation when requested by manufacturers, engineers and purchasing executives or company letterhead. Call or write today for quotations.

**TENSOLITE**  
INSULATED WIRE CO., INC.  
196 MAIN STREET, TARRYTOWN, N. Y.  
Tarrytown 4-2616

KLTI and KLTI-FM in Longview, Texas. Readers are encouraged to submit quiz problems (with correct solutions) for use in this department. For each problem that is accepted for publication, the contributor will receive our check for \$5.00.

*This month's problem.*

What is the resonant frequency of the circuit shown?

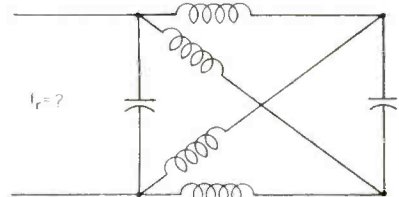

All inductances are 50 mh, and both capacitors have values of 0.01  $\mu$ f.

Answer will appear next month.

**Last Month's Solution**

THE PROBLEM published last month was as follows:

Several years ago a circuit

**UHF OSCILLATOR**

Model 112



An Accurate Signal Source For The Measurement Of

- STANDING WAVES ON TRANSMISSION LINES
- ANTENNA PATTERNS
- FILTERS
- ATTENUATORS

Also for Alignment and Tracking of UHF Receivers

This extremely stable oscillator, with individually calibrated, direct-reading frequency dial, was designed for many applications in UHF engineering.

An output dial calibrated in decibels permits relative voltage measurements within a ratio of 100 to 1.

Specifications:

**FREQUENCY RANGE:**  
300 to 1000 Megacycles.

**FREQUENCY CALIBRATION ACCURACY:**  $\pm 0.5\%$

**OUTPUT VOLTAGE:**  
Maximum varies with frequency between 0.3 volt and 2 volts. Adjustable over 40 db range.

**OUTPUT IMPEDANCE:**  
50 ohms.

**POWER SUPPLY:**  
117 volts; 50/60 cycles; 60 watts.

**DIMENSIONS:**  
12 1/2" x 13 1/2" x 8".  
Weight 22 lbs.

**MEASUREMENTS CORPORATION**

BOONTON



NEW JERSEY

**Specify BREEZE "Monobloc" Waterproof and Pressure Sealed CONNECTORS**

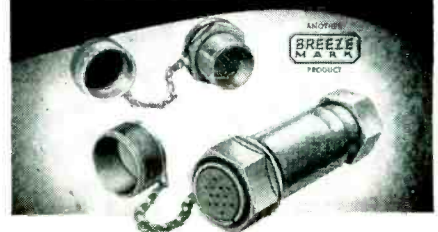

The only APPROVED Monobloc System for Advanced Radar, Communications, and Electronic Equipment

Breeze "Monoblocs", with single piece plastic inserts offer outstanding advantages in assembly, wiring, mounting and service in the field.

- Removable contact pins
- Single hole panel mounting
- Pressure sealed to 75 psi, or higher when required

Breeze "Monobloc" Waterproof and Pressure Sealed Connectors available in aluminum, brass, steel . . . all sizes and capacities . . . fully tested and approved.

WRITE FOR DETAILS . . .

If you have a tough connector problem ask BREEZE for the answer.

**BREEZE**

Corporations, Inc.  
41K South Sixth St.  
Newark 7, New Jersey

## ULTRASONIC DELAY LINES

Designed to withstand continuous temperature cycling over the ranges required by JAN equipment, free of spurious signals.

Extremely low temperature coefficient of delay.

Terminals well shielded to prevent feed-through.

Excellent pulse reproduction for  $\frac{1}{4}$  micro second pulses or better.

Insertion loss to first received signal with electrical terminations of 90 ohms minus 40 DB or better.

Standard operating frequency 30 megacycles. Other frequencies optional.

*Research, Development, and Production to Customer Requirements*

Write today

**ANDERSEN SHAW  
LABORATORIES**

#11 Bragg Street East Hartford, Conn.

## ENGINEERS

**ELECTRONICS  
RESEARCH AND  
DEVELOPMENT**

**In Baltimore, Maryland  
Career Positions  
for**

**Top Engineers and Analysts  
in**

**Radar Pulse, Timing and Indicator Circuit Design  
Digital and Analogue Computer Design  
Automatic Telephone Switchboard Design**

**Also**

**Electro-Mechanical Engineers**

Experience in servo-mechanism, special weapons, fire control, and guided missile design.

Recent E.E. graduates and those with at least one year electronics research and development work will also be considered.

Salary commensurate with ability. Housing reasonable and plentiful. Submit resume outlining qualifications in detail. Information will be kept strictly confidential. Personal interviews will be arranged.

**THE GLENN L. MARTIN COMPANY**  
Employment Department  
Baltimore 3, Maryland

## HIGH VOLTAGE

**20-40 KV VARIABLE  
RF POWER SUPPLIES**

Current output—1 milliamperes  
Input—110 volts AC—60 cycles  
Dimensions— $14\frac{1}{8}$ " x  $11\frac{1}{8}$ " x  $12\frac{1}{8}$ "

## HIGH VOLTAGE

**VARIABLE 0-30 KV DC  
RF POWER SUPPLIES**

Positive or negative outputs POLARITY REVERSIBLE from front panel. Output current 1 mill. Input—110 volts AC—60 cycles. Dimensions:  $14\frac{1}{8}$ " x  $11\frac{1}{8}$ " x  $12\frac{1}{8}$ "

## HIGH VOLTAGE

**15-30 KV REGULATED  
POWER SUPPLIES**

Controlled through knob on front panel. Input voltages: 110 volts AC. Output voltages: 15 to 30 KV. Regulation of .1% at 1 milliamperes

## HIGH VOLTAGE

**VARIABLE 5-20 KV REGULATED DC POWER SUPPLIES**

Regulations better than .1% at 1 milliamperes. Ripple voltages less than 3V peak to peak. Dimensions:  $14\frac{1}{8}$ " x  $11\frac{1}{8}$ " x  $12\frac{1}{8}$ "

## HIGH VOLTAGE

**$4\frac{1}{2}$  to  $7\frac{1}{2}$  KV Power  
Supplies**

Current output: 1 milliamperes. Negative or positive output. Dimensions:  $5\frac{3}{8}$ " x  $4\frac{1}{2}$ " x 5"

A COMPLETE LINE OF HIGH VOLTAGE  
STEP-UP COILS

We also have facilities for hermetically sealing and pressurizing HV units. Write Dept. "E" stating your requirements.

**SPELLMAN TELEVISION CO. INC.**

3029 Webster Ave., Bronx 67, N. Y.  
Kingsbridge 7-0306

## Washington Technological Associates

Incorporated

Technical representation

and advisory service in Washington

for industrial contractors

Dupont Circle Building, Washington 6, D. C.

Michigan 4143

## ROUND TUBES

In addition to our regular line of Square and Rectangular Paper Tubes we are now in a position to supply you with **ROUND TUBES** in sizes from  $\frac{1}{4}$ " ID to 1" ID.

Square and Rectangular tubes from  $1/16$ " x  $1/8$ " to  $10$ " x  $10$ ".

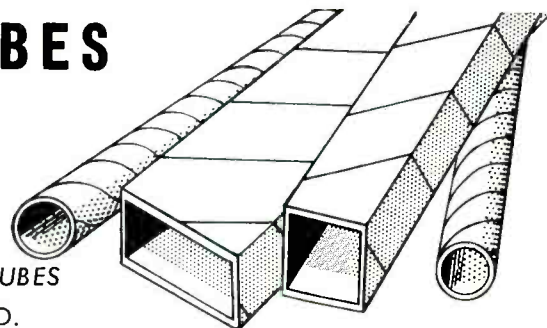

**ACCURATE PAPER TUBE CO.**  
852 NORTH NOBLE STREET  
CHICAGO 22, ILL.



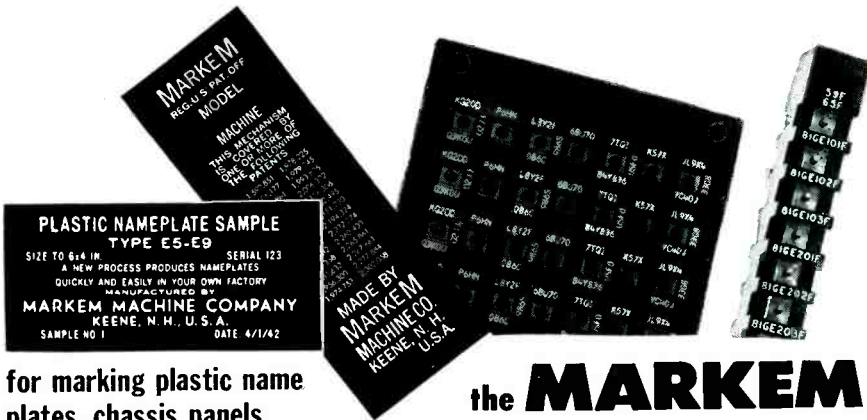

for marking plastic name plates, chassis panels, and other flat plastic surfaces...

## the MARKEM 19A

Here's a Markem machine—designed with the electronics field expressly in mind—to let you imprint directly on plastic, wood, synthetic surfaces, wrinkle finish, metal containers... either painted or unpainted. The 19A will mesh efficiently right into your production line—and save you time and money. With this unique machine you get special features to make your marking operation truly efficient and economical... a Time Control Dwell Clutch to regulate the length of time the printing head is in contact with material to be marked... a printing head adjustable to four tons pressure, equipped with an electrically-heated, thermostat-controlled unit. And—Markem's special typelocking design lets you change variable data swiftly and easily. Write, telling us your marking problem, today. The 19A—or one of many other Markem machines—may be the time-saving, money-saving answer you've been seeking.



Keene 27,  
New Hampshire

in geophysics—physiology—meteorology—seismography—oceanography—spectroscopy—optical pyrometry—in short, wherever low-level electrical phenomena are studied and recorded you will find

## A NEW APPROACH TO PERFECTION with the LISTON-FOLB Ultra-Sensitive D-C AMPLIFIER



1. LOW NOISE LEVEL—approaches theoretical Johnson-Noise limit within factor of 2 or better.
  2. HIGH ZERO STABILITY—0.005 $\mu$ V or better per 8 hours, for protracted accuracy of critical observations.
  3. HIGH GAIN—to actuate rugged meters and relays with fractional  $\mu$ V inputs.
  4. HIGH GAIN STABILITY—0.3% or better per 8 hours; 0.5% or better for line-voltage variations up to 10%.
  5. HIGH LINEARITY—output DC, same polarity as input; linear to 4V with 500-ohm load, to 14V with infinite-impedance meter.
  6. LOW PRICE—other details on request, Dept. E.
- LISTON-FOLB Instrument Co., Inc.  
Stamford, Connecticut, U. S. A.

## .. VARIABLE RF DC HIGH VOLTAGE POWER SUPPLIES ..



MODEL 86—1 to 20 KV—will deliver 250 microamperes at any voltage output up to 20 KV. For voltages up to 10 KV this unit can deliver 500 microamperes.

MODEL 101—5 to 50 KV—will deliver 500 microamperes at any voltage output up to 50 KV. For voltages up to 30 KV this unit can deliver 1.00 milliamperes.

THE CAPACITY LOAD OF A LONG OUTPUT CABLE WILL NOT DISTURB THE RADIO FREQUENCY OSCILLATOR

We are available for additional research and development contracts in the fields of industrial and medical electronics, ultrasonics, induction heating, etc.

INDUCTOGRAPH PRODUCTS, INC. 236 W. 55th St., New York 19, N. Y. • JUdson 6-1549

## C-B a dependable manufacturer of COILS and Electronic Assemblies for military applications.

Your inquiry will receive immediate attention. Prompt quotations from blueprints and on coils to your specifications.

Write, wire or telephone

CADDELL-BURNS MFG. CO.

40 East 2nd St., Mineola, Long Island, N. Y.  
Telephone: Garden City 7-2310

Manufacturers of Kilovolters and Electronic Components for Radio and Television

## OPPORTUNITIES for ENGINEERS SCIENTISTS

GENERAL ELECTRIC COMPANY, Electronics Dept., has excellent opportunities for experienced technical personnel in the following areas:

**ADVANCED DEVELOPMENT DESIGN**—Circuit, component, and product

**FIELD SERVICE TECHNICAL WRITING**

These positions available in the following fields:

TRANSMITTERS, RADAR,  
TUBE RECEIVERS—  
TELEVISION AND  
COMMUNICATIONS

If you have a bachelors or advanced degree in Electrical or Mechanical Engineering, Physics, Metallurgy, or Physical Chemistry and experience in the electronics industry it will be worth your while to investigate these opportunities.

Send complete resume (Listing salary requirements and availability) to: TECHNICAL PERSONNEL, ELECTRONICS PARK, SYRACUSE, N. Y.

General  Electric

# REK-O-KUT

**Turntables are now being specified on Gov't. Contracts for this particular type of equipment!**

*We particularly call your attention to the new*

# REK-O-KUT

**Continuously Variable-Speed Turntable Model CVS-12**

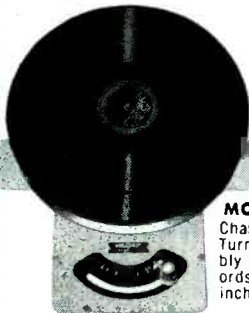

**MODEL-CVS 12**  
Chassis, Motor and Turntable Assembly Plays all records from 6 to 16 inches.

**\$84.95 net**

**Plays at any speed from 25 to 100 R.P.M. without wow. Meets the following Government Specifications for operation and power requirements!**

POWER	VOLTAGE	FREQUENCY
Nominal	115 V.	60 Cycles
Upper Limit	122 V.	65 Cycles
Lower Limit	108 V.	55 Cycles

#### Specifications on Equipment:

Equipment shall rotate records at 78, 45 and 33 $\frac{1}{3}$  and shall be arranged so that those speeds can be established and maintained on the specified power supply, and any slow rate variations, and also within the limit specified as above.

The new REK-O-KUT CVS-12 is the ONLY 12 inch Turntable to our knowledge which will meet these Government Specifications.

Operates on 50 or 60 cycles . . . no pulleys to add or idlers to change. The only Turntable to use in areas of fluctuating voltage, frequency, or with portable power plants.

#### SPECIFICATIONS

Speed Changes: Continuously Variable

(a) 110V—60 Cycles, Range: 25 to 100 R.P.M.

(b) 110V—50 Cycles, Range: 20 to 85 R.P.M.

Turntable—12" cast aluminum, hardened and ground shaft.

Motor—constant speed, 4 pole

Drive—exclusive Rek-O-Kut VARI-CON\* self-seating rim drive.

Noise Level—30db maximum below recording level.

Dimensions—16" L., 12" W., 5" below chassis.

Available at your regular parts distributor. Manufacturer's discounts on request.

# REK-O-KUT CO.

38-23 Queens Boulevard  
Long Island City 1, N. Y.

was needed that would modulate the positive peaks of a carrier wave with one pulse or recurrent wave and at the same time modulate the negative peaks of the same carrier wave with a second and unrelated pulse or recurrent wave . . . and each modulation envelope had to be independent of the other. No vacuum tubes or moving parts were to be used. Design an appropriate "black box" to accomplish the desired purpose.

*Solution.* The circuit shown was submitted by the author of the original question, William H. Fritz of Mamaroneck, N. Y. He substantiates his claims with oscillograms and equations. It should be noted, in studying the circuit, that the two carrier transformer secondary voltages have a phase difference of 180 degrees. The waveforms at various points in the circuit are indicated.

The result is accomplished by the use of two copper-oxide varistors,

*Need*

# RESISTORS?

We have large stocks of precision resistors  $\frac{1}{4}$ ,  $\frac{1}{2}$ , 1 and 2 Watt from 10 Ohm. to 25 Meg. Ohm. Tolerance 1, 2, 5 and 10%, especially suited for television production.

Complete range of resistors up to 50 Watt. Deposited carbon-wire wound, glazed, fixed and adjustable power wire wounds and high voltage types.

If you have a resistor problem, let us help you.

# MONSON

**SALES CORPORATION**  
919 N. MICHIGAN AVE.  
CHICAGO 11, ILLINOIS  
DISTRIBUTOR FOR LEADING GERMAN MFG'S

# PARTRIDGE

The

# AUDIO TRANSFORMERS

that pass  
all tests!

The test of time, no less than test by leading technicians, has proved the range of Partridge Audio Transformers to be the most efficient and reliable. For example the famous

★ **WILLIAMSON** Output TRANSFORMER, of which there is said to be no U. S. equivalent (vide "Audio Engineering" Nov. 1949) is produced to the original specification and comes to you for \$21.00, mail and insurance paid. Then there is the

★ **PARTRIDGE CFB 20** Watt output type, universally accepted as without rival anywhere. Here are some brief figures: Series leakage induct. 10 m.H.; primary shunt induct. 130 H, with 'C' core construction and hermetically sealed—to you for \$30.00, mail and insurance paid.

Send for fullest data, including square wave tests, distortion curves etc. We'll rush this Air Mail together with list of U. S. stock-lists.

★ **YOU CAN JUDGE FOR YOURSELF**

at the  
**RADIO**

**ENGINEERING SHOW, N. Y.**

(STAND 363) March 19th—23rd 1951

where the range of Partridge Audio transformers is being exhibited.

NOTE: We despatch by insured mail per return upon receipt of your ordinary dollar check.

Jobbers are invited to handle the transformer that the States is eager to buy—remember immediate delivery from large stocks in New York!

**PARTRIDGE TRANSFORMERS, LTD.**  
ROEBUCK ROAD TOLWORTH  
SURREY - ENGLAND



# NEW

PRODUCT OF  
**WINCHESTER ELECTRONICS**  
INCORPORATED

IMPROVED CIRCUIT CONNECTORS  
FOR  
AIRCRAFT AND INSTRUMENT USE

Now reduced in size for limited space and weight applications. Type SA Connectors retain all the electrical characteristics of the widely used Type A Connectors. Write for Technical Bulletin.



Receptacle  
SA7S

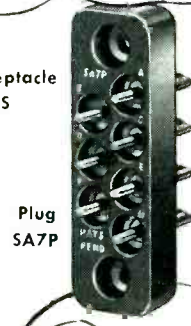

Plug  
SA7P

**Winchester Electronics**  
INCORPORATED  
15 CRESCENT ST. • GLENBROOK, CONN., U.S.A.

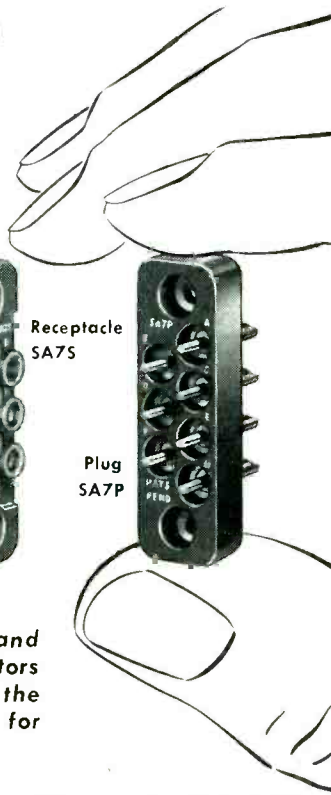

BACKTALK

(continued)

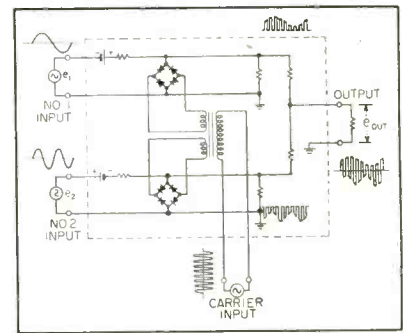

a transformer, six resistors and two bias batteries. It is apparent that the output wave is obtained by adding two nonsymmetrical modulated waves that are displaced by a phase difference 180°. The phase difference is established by the polarity of the carrier transformer.

The mathematical expression for the output waveform precludes the possibility of using such a system to transmit two messages over a single radio carrier. Examination of the expression for  $e_{OUT}$  includes the following components: (a) positive peak modulating frequency  $f_1$ ,

## EXALTED-CARRIER DIVERSITY RECEIVER

A new standard of performance  
in high-frequency reception

Combines all advantages of the best diversity reception plus new exalted-carrier detection which eliminates selective fading distortion and greatly reduces interference from interfering stations within the received channel.

Supplied in compact three-receiver combination with high continuity-of-service factor and switching flexibility.

New diversity selector chooses strongest of the three signals and completely rejects the weaker signals.

For reception of voice, program, or tone-multiplex transmitted by either amplitude or phase modulation.

Exalted-carrier adapters also available for single-receiver use.

*Inquiries invited*



OFFICIALLY APPROVED  
by the Nation's Foremost  
ELECTRONIC MANUFACTURERS!

**ANCHOR**

★ EXCEEDS  
ASTM  
Specifications

★ Conforms with  
IAN (AN-S-62)  
Specifications



**Activated Rosin-Core SOLDER**

The **SHURFLO** Rosin: Speeds up solder flow 25%. Spreads as much as 30% further than ordinary rosin. Has superior wetting and oxide-removing action. Is non-corrosive, non-conductive, safe. Gives no unpleasant odor. Does not carbonize.

Specially designed for all electronic needs. Makes perfect joints on common and difficult metals. 30% more economical to use. Supplied in 1, 5, 20 lb. spools—gauges are fine as 0.020".

SEND NOW for generous **FREE SAMPLE**  
and **CATALOG E-3**

Visit our Display, Booth N-21, IRE Show,  
Grand Central Palace, Mar. 19-22.

**ANCHOR** METAL COMPANY  
87 Walker St., N. Y. 13, N. Y.  
Phone WAlker 5-2569

**CROSBY LABORATORIES, INC.**

126 HERRICKS ROAD

MINEOLA, N. Y.

Garden City 7-6487

# COMPACT-RUGGED

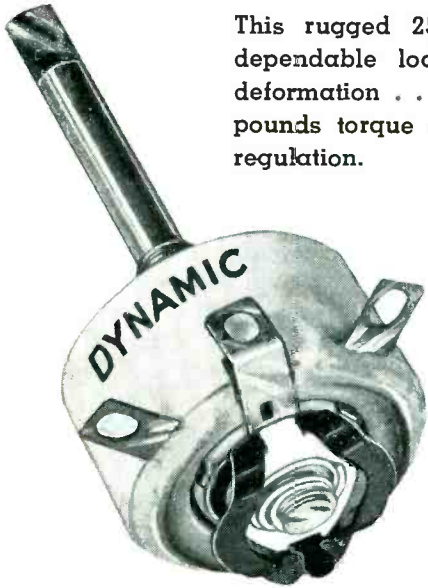

This rugged 25 Watt rheostat with proven dependable lock tab prevents contact arm deformation . . . its steel pin resists over 40 pounds torque . . . assuring constant current regulation.

To make it rugged, we have housed the pure mica strip (on which the resistance element is bound) in vitreous enamel and in turn embedded this in a ceramic base . . . insuring a compact, inseparably bonded unit.

These units are constructed to meet your exacting demands—AND ON SHORT NOTICE.

We also manufacture a wide range of resistors to serve your specific need.

May we quote on your requirements?

25 Watts  
from 5 to  
10,000 Ohms

**DYNAMIC**  
RESISTOR CORPORATION  
6 Cutter Mill Road Great Neck, N. Y.

**SPECIFICATION**

**ELECTROPLATING**



GOLD ALLOY PLATING

GOLD BARREL PLATING

**GOLD • SILVER • RHODIUM**

Complete modern plant. Unlimited production facilities, highly skilled workers plus 40 years of background and experience, your guarantee of complete satisfaction. All required GOVERNMENT SPECIFICATIONS maintained. Also ELECTROPLATING ON ALL PLASTICS.

Write, phone for representative

**COHAN-EPNER CO., Inc.**

142 West 14th St., New York 11, N. Y.  
Phone CHelsea 3-3411

**FOR ORIGINALITY**

LOOK TO **XCELITE**

## The Combination Tool Set To Get The Work Done!

Here are Nos. 1, 2 and 3 Phillips blades quickly reversible to 3/16", 1/4" and 5/16" standard screwdrivers—and the big XCELITE handle which fits them is also a driver for 7/16" hex nuts on TV antenna mounts. That's 7 tools, plastic roll kit and all for only \$4.35. No better bargain in quality tools anywhere. Ask your supplier.

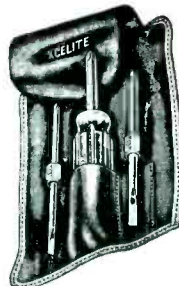

**PARK METALWARE CO., INC.**

Dept. C Orchard Park, N. Y.

Canadians Send Orders Direct to: Chas. W. Pointon, Canadian Warehouse Distributor,  
1926 Gerrard St., E. Toronto, Ont.

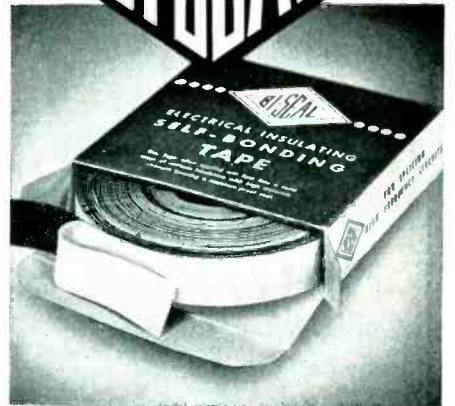

**NOW! SAVE MONEY  
SAVE TIME**

**WITH BI-SEAL  
SELF-BONDING  
POLYETHYLENE  
BASE TAPE**

FORMS INTO A SOLID MASS OF  
INSULATION AND PRODUCES  
MOISTURE TIGHT SEALS  
by means of a gasketing action  
on all materials.

**CHECK THESE EXCLUSIVE FEATURES:**

- ✓ Fuses into a non-laminar homogeneous mass.
- ✓ Excellent dielectric characteristics.
- ✓ A perfect moisture barrier and corona resistant. (Can be used from 175 deg. F to minus 30 deg. F.) Prolonged aging without deterioration.
- ✓ Will not corrode metals.
- ✓ Easy to apply — conforms readily to odd contours.
- ✓ S.I.C. 2.12, P.F. 0.004 @ 10 m.c.

JUST A FEW OF THE MANY BI-SEAL APPLICATIONS:

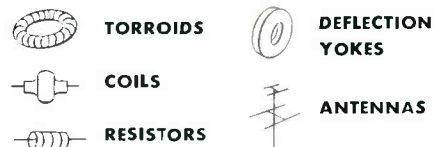

SEND TODAY for FREE SAMPLE Strips,  
Data and Specifications.

BISHOP MANUFACTURING CORPORATION  
254 West 31st Street, New York 1, N. Y.  
Please rush BI-SEAL Data.

Mr. ....  
Title .....  
Company .....  
Address .....



# DEVELOPMENT NECESSITY

## TEKTRONIX TYPE 512 CATHODE RAY OSCILLOSCOPE

- Bandwidth, DC—2 mc
- Sensitivity Range, 5 mv/cm to 50 v/cm [10,000:1]
- Sweep Range, .3 sec/cm to 3 usec/cm
- 1 kc Square Wave Amplitude Calibrator
- Power Supply—Regulated, 105v to 125v
- Portable—Weight 53 lbs.

The Tektronix Type 512 Cathode Ray Oscilloscope was designed specifically as an aid to the development engineer. Convenient comparison of related waveforms, at actual D.C. operating levels, permits intelligent analysis of circuit operation. The 3% accuracy of time and amplitude measuring facilities allows precise determination of circuit characteristics.

Price \$950 f.o.b. Portland, Ore.

Write for further information on this and other  
Tektronix products.

# TEKTRONIX, INC.

712 S. E. Hawthorne Blvd. Portland 14, Ore.



(b) Negative peak modulating frequency  $f_2$ , (c) carrier frequency  $f_c$ , (d) odd harmonics of the carrier frequency,  $n_{ODD}f_c$ , (e) sidebands centered around the carrier frequency,  $f_c \pm f_1$  and  $f_c \pm f_2$ , and sidebands centered around odd harmonics of the carrier frequency,  $n_{ODD}f_c \pm f_1$  and  $n_{ODD}f_c \pm f_2$ . By superimposing the output wave on a carrier of higher frequency it is conceivable that two types of intelligence could be transmitted on a radio carrier and deciphered at the receiver.

### Erratum Color Fundamentals for TV Engineers

IN "Color Fundamentals for TV Engineers, Part I" (December 1950, p 88) Fig. 8 gives the color mixture data for the I.C.I real primaries in watts per watt. These curves indicate the color match that would be found using a device,

## Miniaturize NOW with Bond precision wire wound RESISTORS

OUR WIRE WOUND RESISTORS are always specified where performance under the most severe conditions of temperature, voltage, and humidity is required for stability and long life.

All standard units are protected at no extra cost from humidity and fungi by a special process incorporating two layers of varnish impregnation. After labeling, all resistors are coated with a third layer of a BOND exclusive material protecting the labels and resistors from flame, oil, abrasive material, salt water and extreme thermal shocks.

Miniature type 503 (shown at the bottom of the photograph) rated at a maximum resistance of 125,000 ohms and 1/5 watt dissipation is the smallest non-inductive unit now being manufactured.

The entire BOND line of resistors is manufactured in accordance with JAN-R-93 specifications.

Hi-quality COILS custom built to customer's specifications

BOND coil facilities now available:

- TOROIDAL
- BOBBIN
- INDUSTRIAL
- RADIO
- SOLENOID
- TELEVISION

Send Today for Complete Catalog and Engineering Bulletin

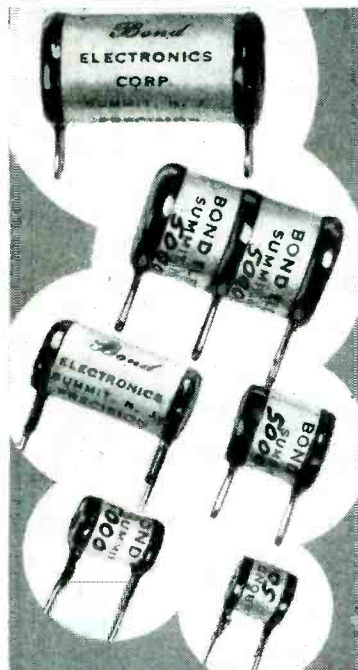

# Bond ELECTRONICS CORP.

88 Franklin Place • SUMMIT, NEW JERSEY



Nickel alloy, filament wire and ribbon: flat—grooved—crowned.

Grid wire electroplated. Alloys for special requirements.

Pamphlet E sent upon request.

## SECON METALS CORPORATION

228 East 45th Street  
New York 17, N. Y.

Telephone: MUrray Hill 7-1594

# CONTACTS

FOR THE FIELD OF ELECTRONICS

## ELECTRICAL

### COILS

#### TO SPECIFICATIONS

Any type construction and materials wound to customer's exact requirements and government regulations.

See us winding at the Universal Winding Co. Booths A. B. & C, I.R.E. SHOW.



**THE FIVE STAR CO.**  
110 Mixville Road  
West Cheshire, Conn.

## EL-TRONICS, INC.

Research, development, and manufacture of electronic equipment—a single model to large quantities.

Write Today for Free Resume of Our Plant Facilities  
*Specialists in Geiger-Muller equipment*  
2647-67 N. Howard St.-Phila. 33, Pa.-GARfield 5-2026



### FLUXES

SODERING  
BRAZING & WELDING

L. B. ALLEN CO. INC.

Chicago 31, Ill.

6751 BRYN MAWR AVE.

## SUB-CONTRACTING MILITARY AND COMMERCIAL

receivers — test equipment  
transmitters — controls  
sub-assemblies

**TELETRONICS LABORATORY, INC.**  
Westbury, L. I., N. Y., Westbury 7-1028

We Design or Build

To Your Specifications

**SPECIAL ELECTRONIC TEST EQUIPMENT**

*Estimates gladly given upon request.*

**MANSON LABORATORIES**

76 Stage Street Stamford, Conn.

## ALUMINUM

Sheets—Circles  
25/35/525

Mill Certification for Defense Orders  
from warehouse stock

**HENRY B. LUST**

310 West 85th St. New York 24, N. Y.  
Telephone: TRafalgar 7-6329

## This CONTACTS Section

supplements other advertising in this issue with these additional announcements of products essential to efficient and economical production and maintenance. Make a habit of checking this page, each issue.

**FINE RIBBONS  
OF  
TUNGSTEN and Molybdenum**

Quality and accuracy in our fabrication of Tungsten & Molybdenum Ribbons have characterized our service to the Electronic industry.

A development of  
**H. CROSS Co.**  
15 Beekman St., New York 7, N. Y.

### high speed high sensitivity SHORTED TURN INDICATOR

The Kartron Shorted Turn and Open Circuit Coil Checker — Model 101B — indicates single shorted turns of #44 wire in unmounted coils.

Standard mandrel 3/16 x 1/4 for all average size coils. Regulated vacuum tube circuit. Jack for audio indication to supplement 1-ma. meter. Prompt deliveries. Price \$150.

**KARTRON** Huntington Beach, Calif.



## MORE THAN 70 DIFFERENT TYPES & SIZES

**MINIATURE BALL BEARINGS** for application in precision mechanisms minimize friction and wear. High load capacity. Least weight and space. Special designs and complete engineering service for your application. Write for catalog E.



**MINIATURE Precision BEARINGS**  
INCORPORATED  
KEENE, NEW HAMPSHIRE, U.S.A.

**EISLER** Manufactures Complete Equipment for:

- SPOT WELDERS, Electric for 1/2 to 250 KVA.
- TELEVISION TUBE GLASS WORKING EQUIPMENT.
- TRANSFORMERS, Special and Standard Types.
- INCANDESCENT LAMP Manufacturing Equipment.
- FLUORESCENT TUBE Manufacturing Equipment.
- NEON SIGN MAKERS EQUIPMENT.
- ELECTRONIC EQUIPMENT, Vacuum Pumps, etc.
- WET GLASS SLICING and Cutting machines for Laboratory use.

**EISLER ENGINEERING CO., Inc.** 751 So. 13th St., Newark 3, N. J.

## A EUROPEAN SOURCE OF SUPPLY INVITES YOUR ENQUIRIES FOR TELEVISION & RADIO PARTS FLUORESCENT LAMPS & ACCESSORIES

Speakers, Resistors, Radio Coils, Potentiometers, Radio Knobs, Lamp Sockets, Pilot Lamp Sockets, Radio—TV & Industrial Condensers, Variable Condensers, Paper— & Mica Capacitors, Crystal Pickups & Cartridges, Transformers, Radio—TV & Microphone Wires and Cables, Wiring Devices, Fluorescent Lampholders, Starters, Ballasts, Fluorescent Lamps, etc. etc.

### SOCIETE INDUSTRIELLE ALFA, S.A.

80, rue de la Senne

Cable : RALFA

Brussels - BELGIUM

— Manufacturers & Exporters of World-Wide Reputation —

The nonmelting **SILICONE** insulating and waterproofing compound, stable at temperatures from -70°F. to +400°F.



### MEETS ALL REQUIREMENTS OF AN-C-128a

More water repellent than paraffin, Dow Corning 4 Compound is highly resistant to oxygen, ozone and to deterioration caused by corona discharge.

**POWER FACTOR**  
up to 10 megacycles... 0.001

**VOLUME RESISTIVITY**  
ohm centimeters... 10"

**DIELECTRIC STRENGTH**  
volts/mil... 500



for switches and contacts in the POWER INDUSTRY



for ELECTRONIC EQUIPMENT

*Write Today!*

for your copy of our new booklet on Dow Corning 4 Compound, Address Dept J



FIRST IN SILICONES

DOW CORNING CORPORATION, Midland, Michigan

*We invite inquiries on*

- ★ Glass to Metal Seals
- ★ Vacuum Switches
- ★ Electronic Devices

## SPERTI FARADAY INC.

Rookwood Pl.  
Cincinnati 2, Ohio



# NOTHELPER

## Special TRANSFORMERS

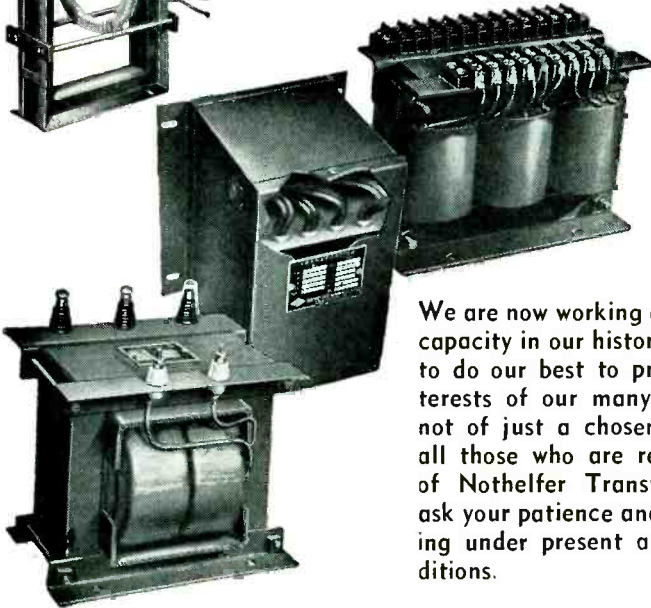
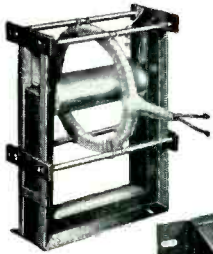

Proven by  
Past  
Performance

We are now working at the highest capacity in our history. We intend to do our best to protect the interests of our many customers—not of just a chosen few, but of all those who are regular buyers of Nothelfer Transformers. We ask your patience and understanding under present abnormal conditions.



**NOTHELPER**  
WINDING LABORATORIES

9 ALBEMARLE AVE., TRENTON 3, N. J.

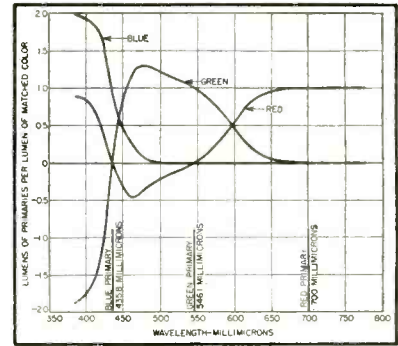

I.C.I. primary mixture data plotted in lumens per lumen

such as a radiometer, receptive to the radiated power, in watts, of the primaries and the matched color. Since the text describes the color matching process in terms of visual observation, using the eye and a colorimeter, the units shown should be visual ones, that is, lumens per lumen. The curves of Fig. 8, redrawn in terms of the latter quantities are shown above.

In Part II of the same series, (January 1950, third column p 83), illuminants B and C were incorrectly defined. Illuminant B is representative of noon sunlight and illuminant C of average daylight.

# GRANT Electronic EQUIPMENT

## SLIDES

for Consoles • Chassis • Racks

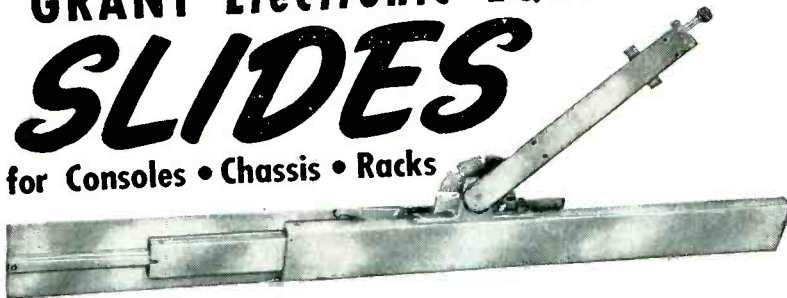

GRANT manufactures standard slides to carry from 25 pounds to 2000 pounds for your every requirement.

GRANT No. 392 Electronic Equipment Slide—Three section, progressive action type slide which locks in open position. Slide includes mechanism for unlocking from outside of chassis and for tilting to 90° angle. Mechanisms vary to suit the individual installation. This slide has been adapted to the standard 19" rack. Load capacity: 100 lbs. per pair depending on length of slide and travel.

- Other outstanding advantages:
- Continuous ball bearing action
  - Closely fitted sides eliminate chassis rattle

- GRANT also manufactures:
- Single or double acting slides
  - Side or undercarriage mounting types
  - Slides with locking and pivoting devices

Consult with our engineering department on any slide problem. Write Dept. E2 for complete illustrated information.

**GRANT PULLEY & HARDWARE CO.**

31-87 Whitestone Parkway, Flushing, L. I., N. Y.



*The foremost name in Sliding Devices*

ENGRAVING

ROUTING

PROFILING

MODELING

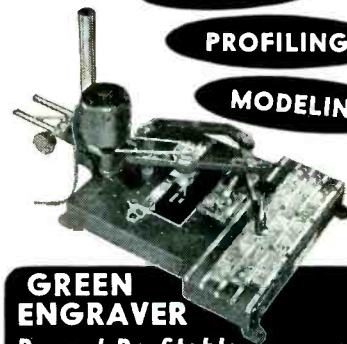

**GREEN ENGRAVER**

Proved Profitable —

Machine Tool, Radio, Electrical and Instrument Mfrs., Sales Promotion and Advertising.

Fast, rugged, convenient—and inexpensive. The Green Engraver is tops for low-cost performance — zips out precision work on metal, plastics or wood . . . cuts four lines of letters from 3/64" to 1" on curved or flat surfaces . . . operates by tracing . . . makes anyone an expert . . . engraves panels, name plates, scales, dials, molds, lenses and instruments. (Also widely used for routing, profiling and three dimensional modeling.) Electric etching attachment available.

Special attachments and engineering service available for production work.

FREE—Fact-packed folder. Send for yours, today

**GREEN INSTRUMENT COMPANY**



363 PUTNAM AVENUE  
CAMBRIDGE, MASS.

# PROFESSIONAL SERVICES

**AMERICAN SPEEDLIGHT CORP.**  
(AFFILIATED WITH J. G. SALTZMAN, INC.)  
HARRY L. PARKER, PRESIDENT and  
CHIEF ENGINEER  
Specialist in Flash and Electronic Equipment  
for Photography.  
Consultation—Development—Design and  
Manufacture  
480 Lexington Avenue New York 17, N. Y.

**MEASUREMENTS CORPORATION**  
*Research & Manufacturing Engineers*  
Harry W. Houck Jerry B. Minter  
John M. van Beuren  
Specialists in the Design and  
Development of Electronic Test Instruments  
Boonton, N. J.

**WHEELER LABORATORIES, INC.**  
Radio and Electronics  
Consulting—Research—Development  
R-F Circuits—Lines—Antennas  
Microwave Components—Test Equipment  
Harold A. Wheeler and Engineering Staff  
Great Neck, N. Y. Great Neck 2-7806

**CROSBY LABORATORIES, INC.**  
*Murray G. Crosby & Staff*  
Radio-Electronic Engineering,  
Research & Development  
FM, Communications, TV  
Test Equipment  
Offices, Laboratory & Model Shop at:  
126 Herricks Rd., Mineola, N. Y.  
Garden City 7-0284

**Eugene Mittelman, E.E., Ph.D.**  
*Consulting Engineer & Physicist*  
High Frequency Heating—Industrial Electronics  
Applied Physics and Mathematics  
549 W. Washington Blvd. Chicago 6, Ill.  
State 2-8021

**YARDENY LABORATORIES, INC.**  
*Research-Design-Development*  
Electro-Chemical Generators of Energy  
105 Chambers Street WORTH 2-3534, 35, 36  
New York 7, N. Y.

**DUBROW DEVELOPMENT CO.**  
*Design — Development — Mfr.*  
Quality Electronic Equipment  
347 High St. Burlington, N. J.  
Burlington 3-0446

**NIAGARA ELECTRON LABORATORIES**  
CONSULTATION - DESIGN - CONSTRUCTION  
MFG. THE THERMOCAP RELAY  
Specializing in solution of problems of electronic  
and electro-physical instrumentation for the re-  
search or analytical laboratory. Industrial plant  
problems also invited.  
Andover, New York Cable Address: NIATRONLAB

**EQUIPMENT  
WANTED**  
(Additional Wanted Ads on pages  
362, 369 & 372)

**EDGERTON, GERMESHAUSEN  
& GRIER, INC.**  
*Consulting Engineer*  
Research Development and Manufacture  
of Electronic and Stroboscopic Equipment  
Specialists in High-Speed Photography  
160 Brookline Avenue, Boston 15, Mass.

**PHYSICAL RESEARCH ASSOCIATES**  
*Consulting Physicists & Engineers*  
Arthur M. Vigilante, Director  
Research, Development, Design and Manufacture  
of Detection and Recording Systems. Industrial  
and Analytical electro-physical instrumentation.  
Dynamic Condenser Electrometers.  
#1 Azurelee Drive Malibu 8444 Malibu, Calif.

\$\$\$  
**WE PAY CASH**  
for all types of  
**RADIO, RADAR, ELECTRONICS  
OR GOV'T. SURPLUS EQUIPMENT**  
Regardless of condition. Top dollars for:  
• ART-13 • I-100 • Signal  
• DY-17 • BC-348 • Generators  
(AC or • Microvolts  
28 V) • Lab. Test  
• TS-12 • BC-788 • Equipment  
• TS-13 • I-152  
Plus anything and everything you have in  
Electronics Equipment. Send Description and  
asking price to:  
**WEST REGION ELECTRONICS**  
Dept. "E", 1437 South Norton Ave.  
Los Angeles 19, California

**ELECTRONIC ENGINEERING  
CO. of CALIFORNIA**  
Radio and Electronic Consulting and  
Designing.  
180 S. Alvarado Los Angeles  
DUunkirk 2-7353 California

**PICKARD AND BURNS, INC.**  
*Consulting Electronic Engineers*  
Analysis and Evaluation  
of Radio Systems  
Research, Development & Design  
of Special Electronic Equipment  
240 Highland Ave., Needham 94, Mass.

**WANTED**  
Equipment for the manufacture of elec-  
tronic tubes. Make or condition not  
important. Give details.  
W-8651, Electronics  
330 W. 42nd St., New York 18, N. Y.

**ERCO RADIO  
LABORATORIES, INC.**  
*Radio Communications Equipment*  
Engineering - Design - Development - Production  
Pioneers in Frequency Shift Telegraph  
Garden City • Long Island • New York

**ALBERT PREISMAN**  
*Consulting Engineer*  
Television, Pulse Techniques, Video  
Amplifiers, Phasing Networks,  
Industrial Appliances  
Affiliated with  
MANAGEMENT-TRAINING ASSOCIATES  
3308-14th St., N.W. Washington 10, D. C.

**WANTED:**  
Small lot of  
**HALLICRAFTER SX-42 RECEIVERS**  
Serial No. over 90,000. Must be in very good  
operating condition. Advise selling price and  
quantity on hand.  
W-8593, Electronics  
330 W. 42nd St., New York 18, New York

**EDWARD A. GAUGLER, Ph.D.**  
*Consulting Physicist*  
Magnetic Materials and their Applications  
419 Shepherd St. Chevy Chase, Md.  
Wisconsin 6106

**SKINNER, HARLAN AND IRELAND, INC.**  
*Consulting Engineers*  
Specializing in Magnetic Materials and  
Their Application  
Office and Laboratory Indianapolis 7, Indiana

**WANTED**  
Tubes, Test equipment, Condensers, &  
general inventories. Highest prices paid.  
W-7965, Electronics  
330 W. 42nd St., New York 18, N. Y.

**PAUL GODLEY CO.**  
*Consulting Radio Engineers*  
GREAT NOTCH, N. J.  
Est. 1926 Little Falls 4-1000

**The Robert H. Streeter Co.**  
*Electronic Design Specialists*  
Engineering Consultants  
Representing Manufacturers  
of Electronic Equipment  
in Southern United States  
Specialists in the design and construction of spe-  
cialized pieces of equipment for specific applications  
Tel. 97 Greenwood, Miss.

**WANTED**  
INSULATORS; POLE LINE HARDWARE;  
GUY STRAND WIRE; COPPERWELD WIRE;  
WESTERN ELECTRIC TOOLS; SPLICING  
SLEEVES.  
**VICTOR-BERNARD INDUSTRIES**  
NE Cor. 22nd & Lehigh Aves., Phila. 32, Pa.

**HANSON-GORRILL-BRIAN INC.**  
*Products & Mfg. Development*  
ELECTRICAL - ELECTRONIC  
HYDRAULIC - MECHANICAL  
One Continental Hill Glen Cove, N. Y.  
Glen Cove 4-1922

**THE TECHNICAL  
MATERIEL CORPORATION**  
*Communications Consultants*  
Systems Engineering  
General Offices and Laboratory  
121 Spencer Place, Mamaroneck, N. Y.

**WANTED TO BUY**  
PRIVATE LABORATORY Wishes to Pur-  
chase for Its Own Use High Grade Test  
Equipment and Basic Radio Components.  
Replies Held in Confidence  
W-8666, Electronics  
330 W. 42nd St., New York 18, N. Y.

**HOGAN LABORATORIES, INC.**  
John V. L. Hogan, Pres.  
*Applied Research, Development, Engineering*  
Est. 1929. Exceptionally competent staff.  
Electronics, Optics, Mechanisms, Facsimile  
Communication, Electro-sensitive record-  
ing media, Instrumentation.  
155 Perry Street, New York 14 CHelsea 2-7855

**TELECHROME, INC.**  
*Electronic Design Specialists*  
COLOR TELEVISION EQUIPMENT  
Flying Spot Scanners, Color Synthesizers, Keyers,  
Monitors, Oscilloscopes and Related Apparatus  
J. R. Popkin-Curman, Pres. & Ch. Engr.  
88 Merrick Rd. Amityville, L. I., N. Y.



## Physicists Mathematicians Electronics Engineers Mechanical Engineers

Cornell Aeronautical Laboratory, an affiliate of Cornell University, has permanent positions open for men of project engineer caliber with advanced degrees and experience in physics, applied mathematics, electronics, and instrument design. Assignments are varied and professionally challenging in fields of pure and applied physics.

The position of our laboratory is between those of universities and commercial research institutes. We believe it combines many of the traditional advantages of both.

Inquiries will be treated as confidential; they should be addressed to

Employment Manager  
Dept. H, Cornell Aeronautical Laboratory,  
P.O. Box 235, Buffalo 21, New York

## SALES ENGINEER

To supervise Sales Department activities for a manufacturer of precision electronic test equipment. Requires technical training and 8 or more years experience in the electronic industry—preferably with test equipment. This opening is for a permanent position with a progressive organization offering stimulating and responsible work, congenial associates and pleasant surroundings.

Resumes, which will be held in confidence, should be submitted directly to the Company. Interviews may be arranged during IRE Convention in New York City.

**BOONTON RADIO CORPORATION**  
BOONTON, NEW JERSEY

## ELECTRONICS Sales Engineers

Positions open for mature graduate sales engineers over 28 years of age, preferably with practical experience in application of dielectric heating to industrial problems. Excellent opportunities for type of individuals interested in affiliation with successful rapidly expanding organization. Locations in Chicago and other territories.

P-8543, Electronics  
330 W. 42 St., New York 18, N. Y.

### WANTED

## SALES REPRESENTATIVES

Man experienced in component sales to television, industrial electronics, and communication equipment fields. Exclusive territories available.

RW-8598, Electronics  
330 W. 42 St., New York 18, N. Y.

## Wanted—Representative FOR SELLING RESISTORS EASTERN TERRITORY

CONTACT:  
**MONSON SALES COMPANY**  
919 North Michigan Ave. Chicago, Ill.

### WANTED

## ELECTRONIC ENGINEER

### Specialist on SUB-MINIATURE TUBES

Must have 5 years' actual experience in taking complete charge of manufacturing.

Non-refundable drawing account against liberal profit participation.

Submit resume, including references, background, and compensation desired.

Reply confidential.

P-8937, Electronics  
330 W. 42 St., New York 18, N. Y.

## ELECTRICAL ENGINEER

Graduate electrical engineer with experience in the design of filter networks and audio transformers. Permanent position with progressive firm located in Chicago. Give details stating age, education, experience, references, availability for work and salary expected.

P-7849, Electronics  
330 W. 42nd St., New York 18, N. Y.

## ELECTRONIC ENGINEER

At least three (3) years post-college experience in development, DC amplifier, digital computers, pulse and servo design. Established Company, New York City.

P-8236, Electronics  
330 W. 42 St., New York 18, N. Y.

REPLIES (Box No.): Address to office nearest you  
NEW YORK: 330 W. 42nd St. (18)  
CHICAGO: 520 N. Michigan Ave. (11)  
SAN FRANCISCO: 68 Post St. (4)

### SELLING OPPORTUNITY OFFERED

REPRESENTATIVES WITH jobbers and manufacturers contacts for molded and tubular paper condenser manufacturer. Supply details and lines handled—most territories open. RW-8912, Electronics.

VARNISH SALESMAN. Opportunity with a future offered by substantial established eastern manufacturer for young experienced aggressive salesman who knows trade. Our own men know of this offer. State complete personal, education and experience background, with salary requirements. SW-8694, Electronics.

### EMPLOYMENT SERVICES

SALARIED PERSONNEL, \$3,000-\$25,000. This confidential service, established 1927, is geared to needs of high grade men who seek a change of connection under conditions assuring, if employed, full protection to present position. Send name and address only for details. Personal consultation invited. Jira Thayer Jennings, Dept. L, 241 Orange St., New Haven, Conn.

OPENINGS:—EE's, BS or equiv. Electronic, Chief Engrs. (const.-maint.), Instructors, Anncr.-tech. (Exp. or student), Xmitter Engrs. 1st (one lic. nec. RRR-Radio-TV Employment Bureau, Box 413, Philadelphia, Pa.

SCIENTISTS' AND ENGINEERS' Ass'n.—Radio Engineering and communications Dept. specializes in confidential placement of qualified personnel—U. S. & overseas. Write Dept. Mgr., Mrs. R. M. Fish, Woodbine Rd., Stamford, Conn.

### POSITIONS WANTED

SALES ENGINEER Executive twenty years successful sales experience in electrical and electronic fields, past four years sales manager for national components manufacturer, desires connection with reputable firm requiring top ability E.E. degree. Age 47. PW-8777, Electronics.

TEACHING POSITION Desired, physics or electr. eng. with chance for research, Ph.D., specialist computers, servos; fine record as head. analysis group, staff physicist large corp. Many papers, book, references. PW-8761, Electronics.

### POSITIONS WANTED

DEVELOPMENT AND design engineer. Ten years in audio, electro-mechanical, electronic music, and counter circuitry. Able to originate profitable ideas. Desires position West Coast or Chicago. Now employed. PW-8897, Electronics.

SENIOR ELECTRICAL Engineer, Age 33, B.S., M.S., Electronics Major. 10 years research, development and test experience on electro-mechanical devices and instruments. PW-8926, Electronics.

POSITION WANTED—Technical Writer. Nine years' experience writing technical reports in journals on radio communication and television subjects. Two yrs. experience in charge of city branch television sales and service and editor of company magazine on same subjects presently employed in this latter position. Desire placement as technical writer or editor or company journal or charge of production of technical reports on training manuals. Passed experience with federal government. Minimum salary \$6500.00-\$7500.00. David Gnessin, 1171 Berkeley Rd., Columbus, Ohio.

### BUSINESS OPPORTUNITY

Chief Engineer—minor partner position desired in small existing or projected electro-mechanical manufacturing firm engaged in defense activity in central U. S. BS, MS, EE, Professional Electrical Engineer. 6 years development experience. College professor. BO-8872, Electronics.

### WANTED

ANYTHING within reason that is wanted in the field served by Electronics can be quickly located through bringing it to the attention of thousands of men whose interest is assured because this is the business paper they read.

## WANT DEFENSE ORDERS?

YOUR PRODUCTS ARE NEEDED BY  
WEST COAST AIRCRAFT AND  
DEFENSE INDUSTRY

\* \* \*  
We regularly cover buyers of electronic components anxious to place defense orders for your products

\* \* \*  
These buyers say catalogue representation is not enough. They want to deal with someone they know they will see from week to week; who will take an interest in their requirements, expedite when necessary and generally act as a responsible, available representative should.

\* \* \*  
Your products can be sold now on defense orders. We will represent you or act as jobber. Write, wire or call:

**WILLIAM G. ROUTH CO.**  
690 Market St., San Francisco 4, Calif.  
YUkon 6-6202

## ESTABLISHED SALES AGENCY

With following in Illinois and Indiana selling electronic and electrical manufacturers only seeks additional quality line. Confidences respected.

RA-8776, Electronics  
520 N. Michigan Ave., Chicago 11, Ill.

## ELECTRONIC EQUIPMENT

Engineer owner of small electronic manufacturing business with considerable backlog of orders now has invested about \$100,000 including substantial cash. Not in financial trouble and believes the present situation justifies very rapid and substantial expansion. Seeks an associate experienced in this industry either sales, or the physics and engineering of vacuum tube manufacture or circuits, with ideas for products, government and industrial connections, and able to substantially match the present owner's investment.

BO-8925, Electronics  
330 W. 42 St., New York 18, N. Y.

# POSITIONS OPEN IN RESEARCH *and* ADVANCED DEVELOPMENT PROGRAMS

to

Research Physicists  
Senior Electronic Engineers  
Senior Mechanical Engineers  
Engineering Physicists  
Circuit Engineers  
Microwave Engineers  
Vacuum Tube Research Engineers  
Technical Report Writers  
Electronic Technicians

Experienced or Holding Advanced  
Degrees For Research, Design, or  
Development In

R a d a r, Servomechanisms, Com-  
puters, Receivers, Photo Emission,  
Secondary Emission, Converters,  
Pulse and Timing Techniques, Spe-  
cial Test Equipment, Special Pur-  
pose Tubes, Circuit Design, Solid  
State Physics, Light and Electron  
Optics, etc.

*We invite interested personnel with ex-  
perience in the above fields to submit a  
complete and detailed resume of educa-  
tion and experience, together with sal-  
ary requirements and availability date, to:*

The Employment Department

**CAPEHART-FARNSWORTH  
CORPORATION**

FORT WAYNE 1, INDIANA

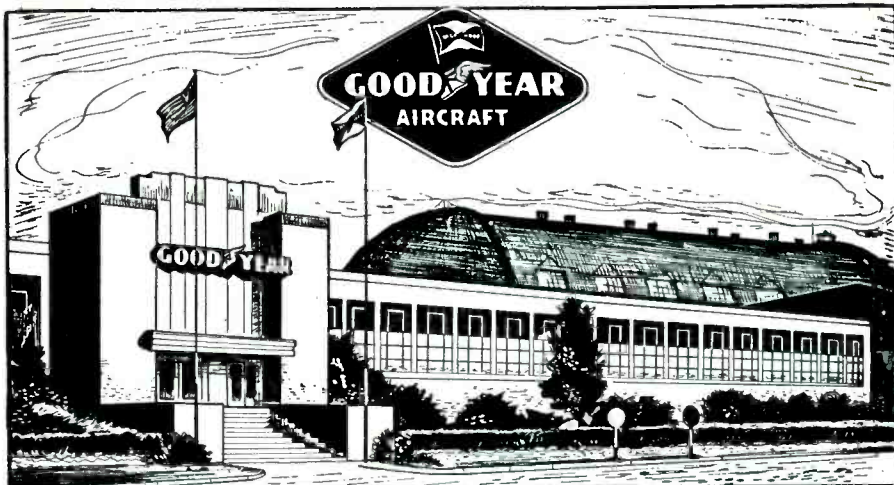

RESEARCH - DEVELOPMENT - DESIGN

*ENGINEERING WITH A FUTURE*

The steady growth of several established research and development projects has created a number of exceptional engineering opportunities with a future.

*PHYSICISTS—ENGINEERS*

Positions are now available in our organization for qualified physicists and engineers with backgrounds in circuit analysis, microwaves, servomechanisms, analog computers, etc. Openings exist at several levels with salaries dependent on education, ability, and experience.

If you are qualified and interested in a position which combines stability and unusual opportunity, write, giving full details to Mr. C. G. Jones, Manager, Salary Personnel.

GOODYEAR  
AIRCRAFT CORPORATION

Akron 15, Ohio

## AEROJET ENGINEERING CORPORATION

### World's Largest Rocket Plant Needs

Electronic and Electrical, Mechanical, and Chemical Engineers for research, design, and development work on rockets, rocket components, and guided missiles.

Give experience, education, age, work references, personal history, salary received and salary expected.

*All inquiries will be considered  
promptly and kept confidential.*

**AEROJET ENGINEERING CORPORATION**  
P. O. BOX 296, AZUSA, CALIFORNIA



BENDIX RADIO DIVISION



**ELECTRONICS ENGINEERS**—At all salary and experience levels.

**RESEARCH ON:** Antennae, Servomechanisms, Microwave ccts. and other phases of communications and navigation equipment.

**PRODUCTION DESIGN OF:** Military and commercial communications and navigation equipment.

**FIELD ENGINEERS** — Supervise installation and maintenance of radio and radar equipment. Factory training will be given. Base salaries from \$4200 to \$6900 per year. 25% bonus for time spent overseas. Traveling and living expenses paid by Bendix. Insurance plan.

**TEST AND INSPECTION ENGINEERS** — Practical knowledge of radio, radar, or TV manufacturing processes. Good knowledge of radio fundamentals essential. Base salaries from \$3900 to \$5880.

**TECHNICAL WRITERS** — Knowledge of radar fundamentals or radio required. Work closely with engineers to gather material for instruction and maintenance manuals. Base salaries from \$3400 to \$4300.

**LABORATORY TECHNICIANS** — Require knowledge of radio fundamentals and skill in use of measuring instruments and laboratory equipment. Previous industrial experience essential. Salaries from \$262 to \$321 per month.

**BASE SALARIES FOR ALL POSITIONS LISTED ABOVE ARE SUPPLEMENTED BY UP TO 30% FOR REGULARLY SCHEDULED 48 HOUR WEEK.**

Housing is no problem in Baltimore.

Excellent group insurance and family hospitalization plan.

Attractive retirement plan for professional personnel.

Write for application:

Engineering Personnel Supervisor  
**BENDIX RADIO DIVISION** of  
 Bendix Aviation Corporation  
 Baltimore 4, Maryland  
 TOWSON 2200

# ENGINEERS

*Needed Immediately*  
 for  
**FAIRCHILD'S**  
*Guided Missile Program*  
**TOP SALARY**

*All Classifications of*  
**ELECTRONIC ENGINEERS**  
*also*  
**ELECTRONIC TECHNICIANS**

*Convenient interviews will be arranged*  
 For prompt consideration send complete resume of education, background and experience to:  
**Personnel Manager**

**FAIRCHILD** GUIDED MISSILES  
 DIVISION  
**FARMINGDALE, LONG ISLAND, NEW YORK**

## ELECTRONIC ENGINEERS

**SENIOR ENGINEERS** or **PHYSICISTS**  
 Degree and experience in Radar, Pulse Circuits, Digital or Analogue Computers, or Servomechanisms  
**JUNIOR ENGINEERS** and recent graduate in EE or Physics.

**ELECTRONIC ENGINEERING COMPANY**  
 OF CALIFORNIA  
 180 S. Alvarado St. Los Angeles 4, Calif.

## PROJECT ENGINEERS

Five years or more of experience in charge of design and development of radio and communication equipment. Must be a graduate of a credited Engineering School. Well equipped laboratory in modern radio and television plant, with excellent opportunities for advancement.

Send resume of qualifications to Mr. S. F. Cascio, Personnel Director of the Hallcrafters Company  
 4401 West Fifth Ave., Chicago 24, Illinois

# POSITIONS AVAILABLE WITH

# VARIAN ASSOCIATES

San Carlos, California  
**MICROWAVE AND ELECTRONIC DEVELOPMENT**

**ENGINEERS**, qualified for work in  
 Microwave research and development  
 Klystron tube design  
 Circuit design  
 Traveling wave tube design  
 Nuclear induction  
**MICROWAVE TUBE TECHNICIANS**  
**TEST TECHNICIANS**  
**TECHNICAL REPORT WRITERS**  
**COMPUTERS**

If you are qualified for one of these positions and are interested in a challenging opportunity with an expanding organization in an attractive environment, you are invited to send confidential details to the Personnel Director:

**VARIAN**  
**associates**

*99 washington st.*  
*san carlos, calif.*

## Research Engineers Electrical Engineers And Physicists

THE FRANKLIN INSTITUTE  
LABORATORIES for RESEARCH  
and DEVELOPMENT

have openings for personnel with 0-10 years' experience. Advanced degrees are desirable in certain of the positions. Fields of interest covered are: Mathematical Analysis of Physical Problems, Statistical Theory of Communications, Electromagnetic Theory, Servomechanisms, Electrical Computing, Advanced and Fundamental Circuit Development, Radar and Pulse Circuits, Operation of G.C.A. or Tracking Radar, Aeronautical Radio, Automatic Controls, Design and Development of Small Mechanical and Electro-mechanical Instruments, and Electrical machinery.

Send resume of education and experience, salary requirements and photograph to:

Personnel Department

THE FRANKLIN INSTITUTE  
Philadelphia 3 Pennsylvania

# electronic engineers and physicists

Organization established in 1942. Electronic research, development, and production must expand to meet long-term, pre-Korea commitments. Openings in all branches of electronics, including

RECEIVERS TRANSMITTERS  
ANTENNAS RADARS  
RELATED EQUIPMENT

Positions available at all levels.

For interview during I.R.E. Convention and Show, inquire at Waldorf-Astoria hotel desk for Company Representative in AIL suite. Or write immediately to Personnel Director of

*Airborne Instruments Laboratory*  
INCORPORATED

160 Old Country Road, Mineola

Long Island, N. Y.

## ELECTRONIC ENGINEERS

For production design of aircraft radio receivers, transmitters, omni, ADF equipment. Outstanding opportunity for experienced capable design engineers and for supervisor to head group.

**LEAR, INC.**

11916 W. PICO BLVD.  
LOS ANGELES 64, CALIF.

## SENIOR ELECTRONIC CIRCUIT PHYSICISTS

for

*Advanced Research  
and Development*

MINIMUM  
REQUIREMENTS:

1. M.S. or Ph.D. in Physics or E.E.
2. Not less than five years' experience in advanced electronic circuit development with a record of accomplishment giving evidence of an unusual degree of ingenuity and ability in the field.
3. Minimum age 28 years.

**Hughes Aircraft Company**

Attention: Mr. Jack Harwood  
CULVER CITY, CALIFORNIA

**The W. L. MAXSON  
CORPORATION**  
IS SEEKING

**Outstanding  
ENGINEERS  
AND  
PHYSICISTS**

with **AMBITION** to

**FURTHER  
PRESENT STANDING**  
*Immediately*

*Minimum Requirements are:*

1. Five to ten years' experience in advanced electronics or in servomechanism and computer research and development.
2. Outstanding record of ingenuity.
3. Ph. D., M.S. or equivalent.

Please send resume and salary requirements to:

**The W. L. MAXSON  
CORPORATION**  
460 W. 34th St.  
New York 1, N. Y.

## VIBRATION ENGINEER

Product development laboratories Kew Gardens, L. I. needs experienced engineer to do shock and vibration work relating to microphonism and strength of vacuum tubes. Must be able to work with and design electro-mechanical devices. EE or ME degree plus minimum 2 years experience in electronics preferably with specific vibration experience. Please address replies to personnel manager,

**SYLVANIA ELECTRIC PRODUCTS INC.**  
40-22 Lawrence St. Flushing, N. Y.



# Experienced ELECTRONICS ENGINEERS... FOR

*Development Design and  
Field Engineering of  
Electronic Equipment*

A limited number of openings for Engineers  
with **PULSE** and **MICROWAVE** experience.

EXCELLENT WORKING CONDITIONS

Apply in writing for Personal Interview, giving  
complete resume and salary requirements to:

*Director Of Engineering Personnel*

## HAZELTINE

**Electronics Corporation**

*Engineering for a Quarter of a Century*

58-25 LITTLE NECK PARKWAY  
LITTLE NECK, L. I., N. Y.

## Immediate Openings for ELECTRICAL AND RADIO ENGINEERS

with experience in design of  
electronic circuits and con-  
struction of HF and UHF  
equipment for long range  
programs of design and de-  
velopment of piloted and  
pilotless aircraft. Liberal  
travel allowances, excellent  
housing facilities available.

*Submit resume to*

ENGINEERING PERSONNEL SECTION

## CHANCE VOUGHT AIRCRAFT

P. O. BOX 5907  
DALLAS, TEXAS

## POSITIONS IN THE WEST FOR ELECTRONICS ENGINEERS

For Work in Fields of

Radar

Servomechanisms

Telemetry

Microwaves

Communications

**NOW**

Direct Inquiry To

FIELD TEST DIRECTOR



Box 391

Holloman Air Force Base, New Mexico

### TRANSFORMER DESIGN ENGINEER

Experienced communications engineer with elec-  
tronic transformer design and manufacturing ex-  
perience and preferably carrier background. Per-  
manent West Coast position, excellent future in  
expanding, well-established field. Salary to match  
training and experience. Please give full details in  
first reply.

LENKURT ELECTRIC CO.,  
San Carlos, California

### ENGINEERS - DESIGNERS

EXPERIENCED

in TV receiver, components or similar  
electronic development.

PERMANENT

staff positions with highly rated product  
development company.

Work demands creative talent and high  
professional ability. Unusually fine work-  
ing conditions and equipment.

Designers for Industry, Inc.

2915 Detroit Ave. Cleveland 13, Ohio  
Attention: J. E. Burnett

### SEMI-CONDUCTOR RESEARCH

The International Business Machines  
Corporation has an opening for a quali-  
fied physicist in an expanding program  
of research and development on semi-  
conductors.

*Qualifications include Ph.D. or equivalent  
with extensive experience and fundamental  
background in Solid State Theory.*

Applications with details should be sent  
to the Manager of the Engineering Lab-  
oratory, International Business Machines  
Corporation, Poughkeepsie, New York.

### ENGINEERS WANTED

North Jersey manufacturer wants engi-  
neers thoroughly experienced in any of the  
following lines: Cathode Ray Tubes, Mini-  
ature, Subminiature Tubes, Special Radar  
Tubes, and Circuit Design work. Excellent  
opportunities. Write complete details and  
salary desired in first letter. All replies  
confidential.

P-8957, Electronics

330 W. 42 St., New York 18, N. Y.

## ELECTRONIC ENGINEERS

Excellent opportunities are offered  
by one of the leading concerns in  
the electronic computer field to  
engineers with development or de-  
sign experience in video and pulse  
circuitry or test and maintenance  
experience in the radar, television,  
or computer fields.

Send complete resumes and salary  
requirements to:

Personnel Department

### ECKERT-MAUCHLY COMPUTER CORPORATION

3747 Ridge Avenue, Philadelphia 32,  
Pennsylvania

*Subsidiary of Remington Rand Inc.*

**RADAR,  
COMMUNICATIONS  
and  
SONAR  
TECHNICIANS  
WANTED**

**For Overseas Assignments**

*Technical Qualifications:*

1. At least 3 years' practical experience in installation and maintenance.
2. Navy veterans ETM 1/c or higher.
3. Army veterans TECH/SGT or higher.

*Personal Qualifications:*

1. Age, over 22—must pass physical examination.
2. Ability to assume responsibility.
3. Must stand thorough character investigation.
4. Willing to go overseas for 1 year.

Base pay, bonus, living allowance, vacation add up to \$7,000.00 per year. Permanent connection with company possible.

*Apply by Writing to*

**A-1, P. O. Box 3414  
Philadelphia 22, Pa.**

Men qualified in RADAR, COMMUNICATIONS or SONAR give complete history. Interview will be arranged for successful applicants.

**ENGINEERING  
OPPORTUNITIES**

*In* **Westinghouse**

**Wanted:**

**DESIGN ENGINEERS  
FIELD ENGINEERS  
TECHNICAL WRITERS**

Must have at least one year's experience.

For work on airborne radar, shipborne radar, radio communications eqpt., micro-wave relay, or micro-wave communications.

Good pay, excellent working conditions; advancement on individual merit; location Baltimore.

Send resume of experience and education to: Manager of Industrial Relations,

**WESTINGHOUSE ELECTRIC CORP.**  
2519 Wilkens Ave. Baltimore 3, Maryland

**ATOMIC ENERGY INSTALLATION  
NEEDS  
ELECTRONICS ENGINEERS**

Two to ten years' experience in research, design, development or test. Patent history desirable but not necessary. A variety of positions open for men, with Bachelor's or advanced degree, qualified in one or more of the following fields:

- RELAYS
  - TELEMETERING
    - PULSE CIRCUITS
      - UHF TECHNIQUES
        - SERVO-MECHANISMS
          - INSTRUMENTATION
            - QUALITY CONTROL
              - LOW POWER APPLICATION
                - TEST EQUIPMENT RELATING TO THE ABOVE FIELDS

These are PERMANENT POSITIONS with Sandia Corporation in Albuquerque, New Mexico. Sandia Laboratory is operated by Sandia Corporation, a subsidiary of Western Electric Company, under contract with the ATOMIC ENERGY COMMISSION. This laboratory offers good working conditions and liberal employee benefits, including paid vacations, sick leave, and a retirement plan.

Albuquerque, center of a metropolitan area of 150,000, is located in the Rio Grande Valley at the foot of the Sandia Mountains . . . the heart of the "Land of Enchantment". Climate is sunny, mild and dry the year 'round.

**MAKE APPLICATION TO:**

**PROFESSIONAL EMPLOYMENT DIV.  
SANDIA CORPORATION**

SANDIA BASE

ALBUQUERQUE, NEW MEXICO

**CIRCUIT ENGINEERS**

To direct the development of non-linear circuits. Must have degree in Electrical Engineering or Engineering Physics. Several years' experience required in the analysis and experimental investigation of magnetic amplifiers, pulsed circuits, or electronic circuits operating at carrier and radio frequencies.

A FIRM OPPORTUNITY IS OFFERED TO CREATE AND SUPERVISE A LABORATORY PROGRAM FOR COMPUTER APPLICATIONS.

In replying, state fully: training, detailing advanced physics and math; experience, emphasizing circuit work and supervisory assignments.

All inquiries confidential • Local interviews arranged

*Engineering Research Associates, Inc.*

*Pioneers in the development of Digital Computer techniques*

**St. Paul 4, Minnesota**

*"You will enjoy living in Minnesota"*





# OPPORTUNITIES AT THE BRUSH DEVELOPMENT COMPANY

for PHYSICISTS & ELECTRICAL  
ENGINEERS

Leaders in the Fields of:

Piezo-electric Crystals and Ceramics  
Electro-acoustics—  
Magnetic Recording—  
Ultrasonics—  
Industrial and Research Instrument—

Increased activities and a highly promising future leads us to add to our highly skilled staff. Conditions are friendly and problems highly stimulating and the field offers opportunity for expansion.

Compensation, pension plans and general personnel policies will make these situations highly attractive to the most able people in the field.

Write Vice President in charge of Engineering  
3405 Perkins Avenue; Cleveland 14, Ohio

## CHIEF PRODUCTION ENGINEER

Leading development and manufacturing company in computer and instrument fields has opening in newly organized production division for experienced Chief Production Engineer. **MUST BE QUALIFIED TO ORGANIZE AND STAFF A PRODUCTION ENGINEERING DEPARTMENT.**

Experience in development production, methods, tool engineering, metal working practices, electrical assembly and quality control essential. Salary commensurate with experience and ability.

*Engineering Research Associates, Inc.*

Pioneers in the development of Digital Computer techniques.

St. Paul 4, Minnesota

"You will enjoy living in Minnesota."



## General Electric NEEDS ENGINEERS and PHYSICISTS

Positions available in our Aircraft Gas Turbine Divisions, Lockland, Ohio, and Lynn, Mass. plants for experienced mechanical, electrical, aeronautical and metallurgical engineers and physicists. Please send resume to Personnel Office, Aircraft Gas Turbine Divisions, 920 Western Avenue, West Lynn, Mass.

GENERAL  ELECTRIC

## WANTED

Research and Development Engineers and Physicists with educational background in mechanical, electrical or electronic engineering, physics or engineering physics for openings in plant and laboratory instrumentation, physical measurements, geophysics, and industrial electronics. Prefer persons with two to four years experience in experimental research design and development of instruments, intricate mechanisms, electronic apparatus, optical equipment, servo-mechanisms or allied fields. Positions are of immediate and permanent importance to our operations.

Write Personnel Director

Research and Development Department  
PHILLIPS PETROLEUM COMPANY  
Bartlesville, Oklahoma

## SCIENTISTS AND ENGINEERS

for

challenging research and advanced development in fields of

RADAR  
GYROSCOPES  
SERVOMECHANISMS  
MECHANICAL SYSTEMS  
ELECTRONICS CIRCUITS  
APPLIED PHYSICS AND MATH  
PRECISION MECHANICAL DEVICES  
ELECTRICAL SYSTEM DESIGN  
GENERAL ELECTRONICS  
INSTRUMENTATION  
MICROWAVES  
COMPUTERS  
AUTOPILOTS

Scientific or engineering degree, and extensive technical experience required.

Write:

Manager, Engineering Personnel

**BELL AIRCRAFT CORPORATION**  
P.O. Box 1, Buffalo 5, N. Y.

## AC SPARK PLUG DIVISION

of

## GENERAL MOTORS CORPORATION

PRECISION INSTRUMENT PLANT

Positions now available for highest caliber personnel in the field of airborne automatic electro-mechanical control equipment.

MECHANICAL DESIGN ENGINEERS  
ELECTRONIC ENGINEERS  
SERVO ENGINEERS  
JUNIOR ENGINEERS

New and expanding division of an established firm with 20 years of successful experience in the instrument field. Work involved deals with the manufacture and development of highly complex equipment of the most advanced type.

Write or Apply

AC Spark Plug Division  
**GENERAL MOTORS CORPORATION**  
1925 E. Kenilworth Place  
Milwaukee 2, Wisconsin

## NATIONAL UNION RESEARCH DIVISION

Senior engineers and physicists are needed for research and development of Cathode Ray, Subminiature, Secondary Emission, and highly specialized types of Vacuum Tubes.

Junior Electrical Engineers are desired for training as tube or circuit design engineers.

Men qualified by virtue of education or experience to handle problems in the field of tube or circuit design are invited to send their resumes to:

*Divisional Personnel Manager*

**NATIONAL UNION RESEARCH DIVISION**  
350 Scotland Rd. Orange, N. J.

## TRANSMITTER ENGINEER

Excellent opportunity for a capable transmitter engineer for our application department. A broad experience in power tube circuits with concentration in broadcast or V.H.F. ranges is necessary. This is a permanent position with one of the oldest power tube companies in America and associated with a world-wide organization. We offer excellent possibilities for advancement; salary commensurate with ability. Write full details in confidence.

**AMPEREX ELECTRONICS CORP.**  
25 Washington St., Brooklyn 1, N. Y.

## CIRCUIT ENGINEERS

Physics laboratories, Bayside, L. I., NY needs junior and senior engineers to work on government sponsored projects in the field of radar and navigation. Jr. engineers: BS in EE or physics and a minimum of one year's experience in Circuit development essential. Good background in pulse, r.f., or servo techniques desirable. Sr. engineers: BS in EE or physics and a minimum of 5 years experience in Circuit development essential. Good background in pulse, r.f., or servo techniques desirable.

*Please Address replies to:*

**Personnel Manager**

**SYLVANIA ELECTRIC  
PRODUCTS, INC.**  
40-22 Lawrence St., Flushing, N. Y.

## BENDIX AVIATION CORP. PACIFIC DIVISION

OFFERS IMMEDIATE POSITIONS IN ENGINEERING FOR THE DEVELOPMENT OF GUIDED MISSILES, RADAR, SONAR. SALARY COMMENSURATE WITH EXPERIENCE, TRAINING & ABILITY.

### SENIOR ENGINEERS

Electro-mechanical. Designs for instrumentation, sensing instruments & servo-mechanisms.

### JUNIOR ENGINEERS

For laboratory design & tests & field tests of electronic equipment.

### SENIOR & JUNIOR ENGINEERS

For the design of servo-amplifiers, pulse circuits, amplifiers, antenna, VHF-UHF-transmitters & receivers.

Permanent employment in modern factory with excellent working conditions, including health insurance & vacation plan.

Periodic wage & promotion review.

Address Replies: **ATT: ENGINEERING PERSONNEL MGR.**

## BENDIX AVIATION CORP. PACIFIC DIVISION

11600 Sherman Way

No. Hollywood, Calif.

## ENGINEERS - PHYSICISTS - MATHEMATICIANS

The steady growth of Melpar's research and development program has created a number of exceptional opportunities for qualified engineering personnel in the following classifications:

**Senior Electronic Engineers** to fill responsible positions in equipment design groups or for advanced development on components and circuits.

**Mechanical Engineers** with experience in packaging military electronic apparatus.

**Physicists and Mathematicians** for stimulating work on research problems.

These are permanent positions in a modern, well-equipped laboratory with highly technical professional group. Opportunity for advancement limited only by initiative and ability.

*All replies are held in strict confidence. Send resume to:*

## MELPAR, INC.

452 Swann Avenue

Alexandria, Virginia



**FULLY  
GUARANTEED**

**BRAND NEW SURPLUS OFFERED BY A LEADING**

**A.C. MOTORS**

**5071930**, Delco, 115 V., 60 Cycle, 7000 r.p.m. **Price \$4.50 each net.**

**36938-2**, Haydon Timing Motor, 110 V., 60 cycle, 2.2 w., 4/5 r.p.m.



**Price \$3.00 ea. net.**

**Teledyn Synchronous Motor**, type BC, 110V, 60 cycle, 60 RPM, 6 W. **Price \$4.00 each net.**

**Type 1600 Haydon Timing Motor**—110 V., 60 cycle, 2.2 w., 1/240 r.p.m. **Price \$3.00 each net.**

**Type 1600 Haydon Timing Motor** 110 V., 60 cycle, 2.3 w., 1 r.p.m. **Price \$3.00 each net.**

**Type 1600 Haydon Timing Motor** 110 V., 60 cycle, 2.2 w., 1 1/5 r.p.m. **Price \$3.00 each net.**

**Type 1600 Haydon Timing Motor** 110 V., 60 cycle, 3.5 w., 1 r.p.m. With shift unit for automatic engaging and disengaging of gears. **Price \$3.30 each net.**

**Type 1600 Haydon Timing Motor**, 110 V., 60 cycle, 2.2 w., 1/60 r.p.m. **Price \$3.00 each net.**

**Eastern Air Devices Type J33 Synchronous Motor** 115 V., 400 cycle, 3 phase, 8,000 r.p.m. **Price \$8.50 each net**

**Teledyn Synchronous Motor**, Type B3, 115 V., 60 cycle, 2 r.p.m., 4 w. **Price \$5.00 each net.**

**Barber-Colman Control Motor**, Type AYLC 5091, reversible 24 volts D.C. .7 amps 1 R.P.M., Torque 500 in. lbs. Contains 2 adjustable limit switches with contacts for position indication. Ideal for use as a remote positioner or a beam or television antenna rotator, will operate on A.C. 60 cycle. **Price \$6.50 each net**

**SERVO MOTORS**

**CK 1, Pioneer**, 2 phase, 400 cycle. **Price \$10.00 each net.**

**CK 2 Pioneer**, 2 phase, 400 cycle. **Price \$14.00 each net**

**10047-2-A Pioneer** 2 phase, 400 cycle, with 40:1 reduction gear. **Price \$10.00 each net**

**FPE-25-16 Diehl** Low-Inertia 20 V., 60 cycle, 2 phase, 1600 r.p.m., 85 amps. **Price \$10.00 each net.**

**CK2, Pioneer**, 2 phase, 400 cycle, with 40:1 reduction gear. **Price \$15.50 each net.**

**MINNEAPOLIS-HONEYWELL TYPE 8 Part No. G303AY**, 115 V., 400 cycle, 2 phase, built-in gear reduction, 50 lbs. in torque. **Price \$10.00 each net.**

**Kollsman Type 776-01** 400 cycle 2 phase drag-cup type, fix phase voltage 29, variable phase 35V. maximum, frequency 400 cycle. **Price \$10.50 each net.**

**REMOTE INDICATING  
MAGNESYN COMPASS SET**

**Pioneer Type AN5730-2** Indicator and **AN5730-3** Transmitter 26 V., 400 cycle. **Price \$40.00 per set new sealed boxes.**



**Kollsman Remate Indicating Compass Set** Transmitter part No. 679-01, indicator part No. 680k-03, 26 V., 400 cycle. **Price \$12.50 each net.**

**GYROS**

**Schwein Free & Rate Gyro** type 46800. Consists of two 28 V. D.C. constant speed gyros. Size 8" x 4.25" x 4.25". **Price \$15.00 ea. net.**



**Sperry A5 Directional Gyro**, Part No. 656029, 115 volts, 400 cycle, 3 phase. **Price \$20.00 each net.**



**Sperry A5 Amplifier Rack** Part No. 644890. Contains Weston Frequency Meter. 350 to 450 cycle and 400 cycle, 0 to 130 voltmeter. **Price \$15.00 each net.**

**Sperry A5 Control Unit** Part No. 644836. **Price \$7.50 each net.**

**Sperry A5 Azimuth Follow-Up Amplifier** Part No. 656030. With tube. **Price \$5.50 each net.**

**Sperry A5 Autopilot Indicator**: contains Pioneer AY20 Autosyn 26 V., 400 cycle. **Price \$9.50 ea. net.**

**Pioneer Type 12800-1-D Gyro Servo Unit**. 115 V., 400 cycle, 3 phase. **Price \$15.00 each net.**

**Norden Type M7 Vertical Gyro**. 26 V., D.C. **Price \$19.00 each net.**

**Allen Calculator**, Type C1 Bank and Turn Indicator, Part No. 21500, 28 V. D.C. Contains 28 V. D.C. constant speed gyro. **Price \$10.00 each net.**

**Type C1 auto-pilot formation stick**, part No. G1080A3. **Price \$15.00 each net.**

**GOVERNMENT** approved instrument repair station No. 3564.

**D.C. MOTORS**



**5069625**, Delco Constant Speed, 27 V., 120 r.p.m. Built-in reduction gears and governor. **Price \$7.50 each net.**

**C-28P-1A**, John Oster Series Motor, 27 V., 0.7 amps., 7000 r.p.m., 1/100 h.p. **Price \$4.50 each net.**

**Jaeger Watch Ca. Type 44-K-2** Contact Motor, Operates on 3 to 4.5 volts D.C. Makes one contact per second. **Price \$2.00 each net.**

**General Electric Type 5BA10AJ52C**, 27 V. D.C., 0.65 amps., 14 oz. n. torque, 145 r.p.m. Shunt Wound, 4 lead reversible. **Price \$6.50 each net.**

**General Electric Type 5BA10AJ37C**, 27 V.D.C., 0.5 amps., 8 oz., in. torque, 250 r.p.m. Shunt Wound, 4 leads reversible. **Price \$6.50 each net.**

**General Electric Type 5BA10J18D**, 27 V. 0.7 amps. 110 R.P.M. 1 oz. ft. tarque. **Price \$6.50 ea. net.**

**D.C. ALNICO FIELD MOTORS**

**S. S. FD6-18**, Diehl, 27 V., 10,000 r.p.m. **Price \$6.50 each net.**

**S. S. FD6-21**, Diehl, 27 V., 10,000 r.p.m. **Price \$6.50 each net.**

**5069466** Delco 27.5 V. 10,000 R.P.M. **Price \$10.00 ea. net**

**706343** Delco 27.5 V. 10,000 R.P.M. Shaft 0.5 in. long. **Price \$7.50 ea. net.**

**5068571** Delco 27.5 V. 10,000 R.P.M. with blower assembly. **Price \$15.00 ea. net.**

**5069370** Delco 27.5 V., 10,000 R.P.M. **Price \$15.00 each net.**

**5072400** Delco 27.5 V. 10,000 R.P.M. Shaft 0.5 in. long with worm gear. **Price \$10.00 ea. net.**

**GENERAL ELECTRIC  
D. C. SELSYNS**



**BTJ9-PA8** Transmitter, 24 V. **Price \$4.00 each net.**

**Price \$4.00 each net.**

**8DJ11-PCY** Indicator, 24 V. Dial marked —10° to +65° **Price \$6.00 each net.**

**8DJ11-PCY** Indicator, 24 V. Dial Marked 0 to 360°. **Price \$7.50 each net.**

**AMPLIFIER**

**Pioneer Gyro Flux Gate Amplifier**, Type 12076-1-A. **Price \$25.00 ea. net, with tubes.**

**G. E. Servo Amplifier** Type 2CV2A1, 115 V. 400 cycle. **Price \$10.00 ea. net.**

**Minneapolis Honeywell Amplifier** Type G403, 115 V. 400 cycle. **Price \$8.00**

**INSTRUMENT  
ASSOCIATES**

**37 EAST BAYVIEW AVE., GREAT NECK, N. Y.  
Telephone Great Neck 4-1147**

**Write for Catalog NE100**

U. S. Export License-2140

March, 1951 — ELECTRONICS

**SUPPLIER OF ELECTRONIC & AIRCRAFT EQUIPMENT****IMMEDIATE  
DELIVERY****INVERTERS**

**Wincharger Corp.** Inverter PU/16 type MG 750, Input 24 V.D.C., 60 amps. Output 115 V, 400 cycle, 1 phase, 6.5 amps. **Price \$60.00 each net.**

**Leland type 10285**, Input 28 V. D.C. at 60 amps. Output 115 V. 3 phase at 750 V.A., 26 V., 400 cycle, single phase at 50 V.A.

**Price \$100.00 each net**

**149H, Holtzer Cabot.** Input 28 V. at 44 amps. Output 26 V. at 250 V.A., 400 cycle and 115 V. at 500 V.A., 400 cycle. **Price \$50.00 each net.**

**149F, Holtzer Cabot.** Input 28 V. at 36 amps. Output 26 V. at 250 V.A., 400 cycle and 115 V. at 500 V.A., 400 cycle. **Price \$50.00 each net.**

**12117, Pioneer.** Input 12 V.D.C. Output 26 V., 400 cycle, 6 V.A. **Price \$30.00 each net.**

**12117-2 Pioneer.** Input 24 V.D.C. Output 26 V. 400 cycle, 6 V.A. **Price \$25.00 each net.**

**12116-2-A Pioneer.** Input 24 volts D.C., 5 amps. Output 115 volts 400 cycle single phase 45 watts. **Price \$100.00 each net.**

**5D21NJ3A General Electric.** Input 24 V.D.C. Output 115 V., 400 cycle at 485 V.A. **Price \$25.00 each net.**

**PE 218, Bollentine.** Input 28 V.D.C. at 90 amps. Output 115 V., 400 cycle at 1.5 K.V.A. **Price \$50.00 each net.**

**ACTUATORS**

**White Rodgers Electric Co.** type 6905, number 3, 12 V., D.C., 1.3 amps., 1½ RPM, torque 75" in lbs., contains adjustable limit switches. **Price \$10.50 each net**

**METERS**

**Weston Frequency Meter**, Model 637, 350 to 450 cycles, 115 volts. **Price \$10.00 each net.**

**Weston Voltmeter.** Model 833, 0 to 130 volts, 400 cycle. **Price \$4.00 each net.**

**Weston Voltmeter.** Model 606, Type 204 P, 0 to 30 volts D. C. **Price \$4.25 each net.**

**Weston Ammeter.** Model 506, Type S-61209, 20-0 100 amps. D. C. **Price \$7.50 each net with ext. shunt.**

**Weston Ammeter.** Type F1, Dwg. No. 116465, 0 to 150 amps. D. C. **Price \$6.00 each net. With ext. shunt \$9.00 each net.**

**Westinghouse Ammeter.** Type 1090-D-120, 120-0-120 amp. D. C. **Price \$4.50 each net.**

**Westinghouse Ammeter,** type E1, part No. 1162965, range 0-300 amps. D.C. **Price \$7.50 each net.**

**Weston Voltammeter,** type 201-P, Mod. 606, range 0-30 volts D.C. and 0-30 amps. with shunt. **Price \$12.50 each net.**

**CARBON PILE VOLTAGE  
REGULATOR**

**Leland Electric Co.,** type B, Philco Spec. 451-1288, input 21 to 30 Volts D.C., regulated voltage 18.25 at 5 amps. **Price \$6.50 each net.**

**Western Electric Transtat Voltage Regulator,** W.E.Co Spec V-122855, load K.V.A. 0.5, input 115 volts, 400 cycles, V.A. 126, max amps 5.5, output adjustable 92-115 volts, Western Electric No KS 5945L01 **Price \$10.50 each net.**

**RECTIFIER POWER SUPPLY**

**General Electric,** Input 230 V. 60 cycle 3 phase. Output 130 amps. at 28 V. D.C. Continuous duty, fan cooled, has adjustable input taps. G.E. model No. 6RC146F. Size: Height 46", width 28", depth 17½". **Price \$225.00 each net. New**

**PIONEER AUTOSYNS**

**AY1, 26 V., 400 cycle.** **Price \$7.50 each net.**

**AY14G., 26 V., 400 cycle, new with calibration curve.** **Price \$15.00 each net.**

**AY20, 26 V., 400 cycle.** **Price \$7.50 each net.**



**AY5, 26V., 400 cycle. Has hollow shaft.** **Price \$7.50 ea. net.**

**AY54D, 26 V., 400 cycle, with pointer for I 81 & I 82 Indicator.** **Price \$10.50 each net**

**PRECISION AUTOSYNS**

**AY131D, new with calibration curve.** **Price \$35.00 each net.**

**PIONEER AUTOSYN  
POSITION INDICATORS**

**Type 5907-17.** Dial graduated 0 to 360°, 26 V., 400 cycle. **Price \$20.00 each net.**

**Type 6007-39, Dual, Dial graduated 0 to 360°, 26 V., 400 cycle.** **Price \$30.00 each net.**

**MAGNETIC AMPLIFIER  
ASSEMBLY**

**Pioneer Magnetic Amplifier Assembly** Saturable Reactor type output transformer. Designed to supply one phase of 400 cycle servo motor. **Price \$12.50 each net.**

**PIONEER TORQUE UNIT  
AMPLIFIER**

**Type 12073-1-A,** 5 tube amplifier, Mag-nesyne input, 115 V., 400 cycle. **Price \$17.50 each net with tubes.**

ALL PRICES,  
F. O. B.  
GREAT NECK,  
N. Y.

**BLOWER ASSEMBLY**

**John Oster, MX-215/APG 28 V.D.C.,** 7000 r.p.m. 1/100 h.p. **Price \$8.50 each net.**

**Westinghouse Type FL Blower,** 115 V., 400 cycle, 6700 r.p.m., Airflow 17 C.F.M. **Price \$7.50 each net.**

**RATE GENERATORS**

**F16, Electric Indicator Co.,** two-phase, 22 V. per phase at 1800 r.p.m. **Price \$12.00 each net.**

**J36A, Eastern Air Devices,** 02 V. per r.p.m. **Price \$12.50 each net**

**B-68, Electric Indicator Co.,** Rotation Indicator, 110 V., 60 cycle, 1 phase. **Price \$14.00 each net.**

**PM-1-M Electric Indicator Co.** Same as type B35. 2 V. per 100 R.P.M. Max. speed 5,000 R.P.M. Can be used as D.C. motor, 1/77 H.P. 115 V. D.C. **Price \$14.00 ea. net.**

**SINE-COSINE GENERATORS**

(Resolvers)

**FPE 43-1, Diehl,** 115 V., 400 cycle. **Price \$20.00 each net.**

**SYNCHROS**

**1F Special Repeater,** 115 V., 400 cycle. Will operate on 60 cycle at reduced voltage. **Price \$15.00 each net.**



**2J1F3 Selsyn Generator** 115 volts, 400 cycle. **Price \$5.50 each net.**

**2J1G1 Control Transformer,** 57.5/57.5 V., 400 cycle. **Price \$1.90 each net.**

**2J1H1 Selsyn Differential Generator,** 57.5/57.5 V., 400 cycle. **Price \$3.25 each net.**

**W. E. KS-5950-L2, Size 5 Generator,** 115 V., 400 cycle. **Price \$10.00 each net.**

**1G Generator** 115 V., 60 cycle. **Price \$40.00 each net**

**5G Generator** 115 volts, 60 cycle. **Price \$50.00 each net.**

**2J1F1 Selsyn Generator,** 115 V., 400 cycle. **Price \$3.50 each net.**

**5SDG Differential Generator** 90/90 V., 400 cycle. **Price \$15.00 each net.**

**1CT Control Transformer,** 90/55 volts, 60 cycle. **Price \$40.00 each net.**

**POSITION TRANSMITTER**

**Pioneer Type 4550-2-A** Position Transmitter, 26 volts 400 cycle, gear ratio 2:1. **Price \$15.00 each net.**

**INSTRUMENT  
ASSOCIATES**

37 EAST BAYVIEW AVE., GREAT NECK, N. Y.  
Telephone GREAT NECK 4-1147

Write for Catalog NE100

Western Union address:  
WUX Great Neck, N. Y.



**LOW  
PRICES**

**IMMEDIATE  
DELIVERY**

**FULLY  
GUARANTEED**

**BROWN TELEPLOTTER  
RECEIVER**

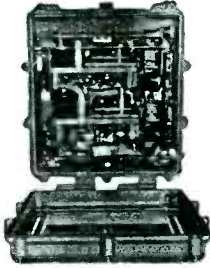

**Model 791X1R**  
115 volt 60 cycles

Contains a pen driven by two balancing motors which writes on rear of a translucent chart. Pen arm position is in terms of two coordinated balancing motors thru two amplifiers. Originally intended for recording plotted or written data from central plotting board. Writes at one half scale on 18 in. chart. Discriminator input circuit designed to operate unit as function of two varying R.F. frequencies varying about mean of approx. 430 KC. Further data on request. (Shipping weight 435 lbs.)

**Price \$375.00**

**Aircraft Generator  
Eclipse NEA-3**



Output 115 VAC; 10.4 amps 800 cycles at 2400 rpm. Also 30 VDC at 6 amps. Stock #SA-306. Price \$39.50 each.

**400 Cycle Generator**



G. E. 5ASB31J33. 400 cycles out at 115 volts 7.2 amps. Ideal for lab. 6" lg. x 6" diam. 8000 rpm. Stock #SA-292. Price \$79.50 ea.

**A-5 Autopilot  
Indicator**



Autosyn Type Pilot Indicator for A-5 Autopilot. 26 v. 400 cycles. Stock #SA-299. Price \$12.50 each.

**Pioneer Servo Motor**



Type 10047-2A. 2 φ 400 cycle low inertia. 26 v fixed phase. 45 v. max. variable phase. Stock #SA-90. Price \$12.50 each.

**PRECISION AUTOSYN**



Pioneer Type AY-150 Control Autosyn. Precision type. 26 v. 400 cycle. Stock #SA-297. Special low price \$14.50 each.

**SYNCHROS**

**Navy Types**

1G, 1CT, 5G, 5CT, 5DG, 5HCT, 5SF, 5HSF, 5SDG, 6DG, 7G, etc.

Prices on Request



**Compass Indicator**  
I-82F Compass Indicator. 0-360°-5 in. dial. 26 v. 400 cy. 8-12 v. 60 cy. Ideal position indicator. Stock #SA-284.

**Price \$6.50 each**

**SWEEP GENERATOR CAPACITOR**



Hi-speed bearings. Split stator. Silver-plated coaxial type. 5-10 mmf.

Stock #SA-167

**Price \$2.75 each**

**ALSO IN STOCK**

**C-1 AUTOPILOT COMPONENTS**  
A-5 AUTOPILOT GYROS  
GENERAL ELECTRIC D-C SELSYNS  
AC and DC RATE GENERATORS

**400 CYCLE AC BLOWERS**

E. A. D. J-151—115 v. 400 cy. 22 c.f.m.  
Westinghouse Type FL—115 v. 400 cy. 17 c.f.m.

**DC MOTORS**

Haydon-0666, 1/2 rpm. 29 v. d-c. 100 ma.  
Delco 5069625—120 rpm. Gov. cont. 27 v.  
General Electric 5BA50LJ66—1/2 hp. 27 v. field. Arm. v. 60. Amplidyne controlled.  
Delco-A-7155—1/30 hp. 3600 rpm. Gov. cont.  
W. E. KS-5603-102—1/100 hp. 4 lead shunt.  
National Mineral—90600. 1 hp. Int. duty. Fan cooled.  
Diehl FBE-53-5—3600 rpm. Gov. cont. 1/30 hp.  
G. E. 5BA25MJ409—24 v. 7500 rpm. Cont. duty.  
Airsearch—Actuator—25800-24. 2" travel.  
Barber Colman—Actuator—YLC-2066-2. 200 in/lb. 135 degrees in 45 seconds.  
Airsearch—Actuator (Manual Flap) 25080.  
Airsearch—Actuator—(Automatic Flap) 25040.  
Holtzer Cabot—RBD-2220—1/2 hp. 27 v. 3600 rpm.  
Arma Latitude Motor—8413-30 (Step motor).  
Elinco B-64—1/165 hp. 3100 rpm. 27 v. f. 80 v. armature. (Thyatron control).  
John Oster—A-21E-12R—Split field series reversible. 28 v. 0.4 amps. 2 watts output.  
General Electric 5PSS6HC18—Split field series rev. 60 v. 1.4 A. 3500 rpm.

**AC SERVO MOTORS**

Kollsman—776-01—400 cy. 2 φ drag cup type.  
Diehl FP-25-3—2 φ 60 cy. 20 v. 2.5 watts out.  
Pioneer CK-2—2 φ 400 cy. 1.05 in/oz. stall.  
Pioneer CK-17—2 φ 400 cy.  
Minneapolis Honeywell G303AY2CA1. Built in gear reduction. 2 φ 400 cy.

**AUTOSYNS (Pioneer)**

B-9A—Dual Oil Pressure Indicator (6007-4F-7A).  
B-9A—Oil Pressure Transmitter, (4150-3B3).  
Pioneer Types—AY-1, AY-14, AY-54, 2320, etc.  
C-14A—Fuel Pressure Transmitter.  
Pioneer I-81A and I-82A Compass Indicators.

**Subfractional Horsepower AC Motors**

Eastern Air Devices-J-72B—115 v. 400 cy. 1/50 hp. Cont. duty. 4700 rpm.  
E. A. D. J-49B—115 v. 400 cy. 1/250 hp.  
E. A. D. J-33—115 v. 3 φ 400 cy. Int. duty.  
Diehl FBF-24-1—115 v. 400 cy. 1/100 hp.  
Synchro-600—110 v. 60 cy. 1 rpm.  
Haydon 36228—115 v. 60 cy. 1 rpm.

**MAGNESYNS**

Pioneer Type CL-3, 6 power.  
Pioneer 1006-1E-B1 Indicator. AN-5730-2.

**INVERTERS**



**Wincharger PU-7/AF**  
Input 28 VDC at 166 amps. Output 115 v. 400 cy. 1 φ at 2500 VA. Voltage and frequency regulated. Cont. duty. Stock #SA-164. Price \$89.50 each.



**G. E. 5AS131N-33 (PE-118)**  
Input 26 VDC at 160 amps. Output 115 v. 400 cy. 1 φ at 1500 VA. PF 0.8 W.E. Spec. Stock #SA-286. Price \$29.50 ea.



**PE-218E Inverters**  
Russel Electric and Leland. Input 28 VDC at 94 amp. Output 115 v. 400 cycles at 1500 VA. PF 0.9. Stock #SA-112A. Price \$49.50 each.

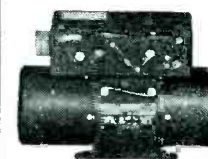

**Pioneer 12130-4-B**  
Input 28 VDC at 14 amps. Output 120 v. 400 cy Single Phase at 1.15 amps. (140 V.A.) Voltage and frequency regulated. Made 1949. Stock #SA-304. Price \$89.50 each.

**JACK AND HEINTZ STARTER**



Dwg. 6-950-R  
Aircraft engine starter 28 V D C. Stock #SA-305. Price \$19.50 each

**DC SERVO MOTOR**



**Elinco Type B-61.**  
1/65 hp at 3100 rpm. Field volts 27.5 Max. armature voltage 80. Ideal for thyatron servo control. Stock #SA-211. Price \$12.50 each.

**MAGNETIC AMPLIFIER ASSEMBLY**

Sperry 661B34. Saturable reactor type output transformer. Designed to supply one phase of 400 cycle servo motor. Stock #SA-288. Price \$6.75 each.

**FORD INS'T SERVO MOTOR**



115 volt 60 cycles two phase low inertia motor. 15 watts output. BuOrd. 207927. Stock #SA-291. Price \$49.50 each.

Write for complete listing,  
or call ARmory 4-3366

**SERVO-TEK**  
**PRODUCTS Co.**  
Incorporated  
Surplus Division

Open account shipments  
to rated concerns.  
All prices F.O.B. Paterson, N. J.

4 Godwin Ave.

Paterson, N. J.



**RADAR ANTENNAS**

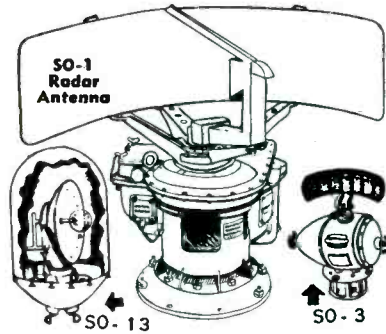

Type SO-1 (10 CM.) Complete assembly with reflector, waveguide nozzle, drive motor and synchros, etc. New in original cases. \$279.50  
 Type SO-3 (3 CM.) Surface Search type complete with reflector, drive motor, synchro, etc., but less plumbing. New in original cases. \$189.50  
 Type SO-13 (10 CM.) Complete assembly with 24" dish with feedback dipole. Complete with synchros, drive motor, searing, etc. New in original cases. \$149.50  
 Also in stock—spare reflectors, nozzles, probes, right angle bends for SO-1 antennas.

**400 CYCLE TRANSFORMERS**

AUTO. 400 cy. G.E. Cat No. 80G184  
 KVA .945S—520P. Volts 460/345/230/115. New \$4.95  
**FILAMENT.** 400/2800 cy. Input: 0/75/80/85/105/115/125V. Output: 5V3A/5V3A/5V3A/5V3A/5V6A/5V6A/6.3V6A/6.35A. New \$2.95  
**THYRATRON POWER.** 400/1600 cy. Raytheon UX-8876. 400/1600 cy. Pri: 115. Sec: 50-0-50V at 0.5A, 6.3V at 1.2A. Test r.m.s. 1780. New...\$2.75  
**PLATE WECO KS9560.** 400/800 cy. Pri: 115V. Sec: 1350-0-1350 at .057A (2700 V Total). Elecstat shlded. Wt. 2.3 lbs. New...\$2.95  
**SCOPE PL. & FIL. WECO 9556.** 400/2400 cy. Pri: 115. HV. Wdg. 1125V at .008A. Fil. Wdgs. 6.4V4A/2.5V1.75A/6.4V.6A. Elecstat shlded. Wt. 1.4 lbs. New...\$2.75  
**FILAMENT.** 400/2400 cps. WECO KS9553. Pri: 115V. Sec: 8.2V1.25A/6.35V1.5A Elecstat shlded. Wt. 0.6 lbs. New...\$1.95  
**PLATE & FIL.** 400/2800 cy. Pri: 0/80/115V. Sec #1=1200VDC at 1.5MA. Sec #2=400VDC at 130MA. Fil. Secs: 6.4V4.3A/6.35V0.8A. (Ins. 1500V)/6V2A/5V2A \$4.95  
**RETARD.** 400 cy. WECO KS9598. 4 Henry 100MA \$1.75

**60 CYCLE TRANSFORMERS**

**FILAMENT.** Raytheon Hypersil Core. Pri: 115V. Sec: 6.3V22A/6.3V2.4A/6.3V2.25A/6.3V0.6A Ins. for 1700V \$5.95  
**Plate.** Thordarson #T46889. 1650 VA. Pri: 105-120V. 60 cy. 1 PH. Sec: 5600V. Center tapped. 7.5KV insulation. Brand new...\$49.50  
**High Reactance Trans.** G. E. type Y-3502A.—60 cy. Voltage 11200-135. Inductance H.V. Winding 135 Henries. Output Peak Voltage 22.8KV. Cat. 8218065Q1. New \$89.50  
**High Voltage Trans.** Westinghouse 7,500 volt or 15000V Voltage Doubler at 35MA...\$24.50

**PULSE TRANSFORMERS**

**PULSE.** WECO KS-9563. Supplies voltage peaks of 3500V from 807 tube. Tested at 2000 Pulses/sec and 5000V peak. Wdg. 1-2=18 ohms. Wdg. 1-3=72 ohms. L of Wdg. 1-3=.073-.082H at 100 cps. \$5.50  
**PULSE.** WECO KS-161310. 50 KC. to 4MC. 1 1/2" Dia. x 1 1/2" high. 120 to 2350 ohms. New...\$3.95

**SOUND POWERED BATTLE PHONES**

Western Electric No. D173312, Type O. Combination headset and chest microphone. Brand new including 20 ft. of rubber covered cable...\$17.50  
 Automatic Elec. Co. No. GL843AO. Similar to above but including Throat microphone in addition to chest microphone. Brand new with 20 ft. rubber covered cable...\$13.50  
 U. S. Instrument Co. Navy Type M. Dr. No. A-260 ALT. 1. Complete with 20' cable and navy plug. Brand new \$17.50

All prices indicated are F O B Bronxville, New York. Shipments will be made via Railway Express unless other instructions issued.

**MICROWAVE RECEIVERS**

**AN/APR-1** Receivers and tuning units TN-1 (38 to 95 MC) TN-2 (76-300 MC) TN-3 (300-1000 MC)  
**AN/APR-4** Receivers and tuning units TN-16 (38-95 MC) TN-17 (76-300 MC) TN-18 (300-1000MC)  
**AN/APR-5A** Receivers. 1000 to 6000 MC Range.

**LAVOIE FREQ. METER**

375 to 725 MCS

Model TS-127/U is a compact, self-contained, precision ( $\pm 1$  MC) frequency meter which provides quick, accurate readings. Requires a standard 1.5V "A" and 45V "B" battery. Has 0-15 minute time switch. Contains sturdily constructed HI-"Q" resonator with average "Q" of 3000 working directly into detector tube. Uses 957, L86 and 3S4 Tubes. Complete, new with inst. book, probe and spare kit of tubes. Less batteries. Write for descriptive \$69.50

**PARABOLOIDS**

Spun Magnesium dishes 17 1/2" dia. 4" deep. Mounting brackets for elevation and azimuth control on rear. 1 1/2 x 1 1/2" opening in center for dipole. Brand new per pair...\$8.75

**SWEET GENERATOR CAPACITOR**

High speed ball bearings. Split stator silver plated coaxial type 5/10 mmfd. Brand new...\$2.50

**RAYTHEON VOLTAGE REGULATOR**

Adj. input taps 95-130V., 60 cy. 1 Ph Output: 115V., 60 Watts, 1/2 of 1% Reg. Wt. 20 lbs. 6 1/2" H x 8 1/2" L x 4 1/2" W. Overload protected. Sturdily constructed. Tropicalized. Special...\$14.75

**MODEL AN/APA-10 PANORAMIC ADAPTER**

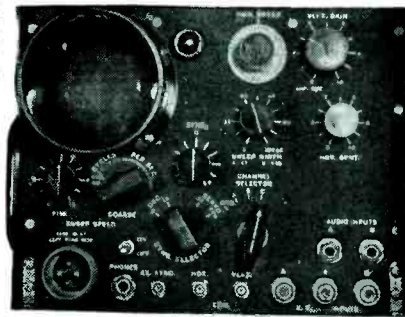

Provides 4 Types of Presentation:

(1) Panoramic (2) Aural

(3) Oscillographic (4) Oscilloscopic

Designed for use with receiving equipment AN/ARR-7, AN/ARR-5, AN/APR-4, SCR-587 or any receiver with I.F. of 455kc, 5.2mc, or 30mc.

With 21 tubes including 3" scope tube. Converted for operation on 115 V. 60 cycle source.

PRICE \$245.00  
 AN/APA-10 80 Page Tech Manual...\$2.75

**G. E. SERVO AMPLIFIER**

Type 2CV1C1 Aircraft Amplidyne control amplifier, 115 volts—400 cycles. Dual channel. Employs 2-6SN7GT and 4-6V6GT tubes. Supplied less tubes. New \$22.50



**LINEAR SAWTOOTH POTENTIOMETER**  
 W.E. KS-15138

Has continuous resistance winding to which 24 volts D.C. is fed to two fixed taps 180° apart. Two rotating brushes 180° apart take off linear sawtooth wave voltage at output. Brand New \$5.50

**HIGH VOLTAGE CAPACITORS**

25 MFD., 20KV \$26.50  
 25 MFD., 15KV 22.50  
 .5 MFD., 25KV 34.50  
 1 MFD., 15KV 34.50  
 1 MFD., 7.5KV 12.50

**MOTOR GENERATORS DYNAMOTORS, INVERTERS, ETC.**

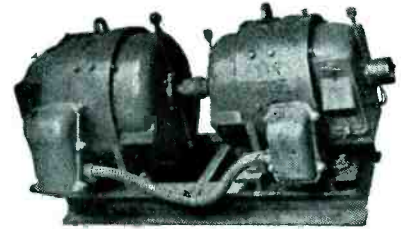

2.5 KVA MG SET. Diehl Elec. Co. 115V DC to 120V AC, 60 cy. 1 Ph. Complete with Magnetic Controller, 2 Field Rheos and Full Set of Spare Parts including Spare Armatures for Generator and Motor. Full specs. on request. New \$285.00

2 KVA MG SET. O'Keefe and Merritt. 115V DC to 120V AC, 60 cy. Idles as 3 Ph. sync motor on 208V, 50 cy. New. Export crated. \$165.00

1.25 KVA MG SET. Allis-Chalmers. 230 DC to 120V AC, 60 cy. 1 Ph. Fully enclosed, Splashproof Ball Bearings, centrifugal starter. NEW \$150.00  
 Kit of Spare Parts...\$25.00

MG Set. Onan MG-075. Navy type PU/11. Input 115/230, 60 cy, 1 Ph. Output 115, 480 cy, 1 Ph. 5.3 amps and 26V DC at 3.8 amps. New...\$198.50

MG Set. Onan MG-215H. Navy type PU/13. Input 115/230, 60 cy, 1 Ph. Output 115, 480 cy, 1 Ph. 1200W and 26V DC at 4 amps. New...\$295.00

MG SET FOR NAVY TBS TRANSMITTER. Type CG-21302. 440V AC, 60 cy. 3 Ph, 1500 VA to 875V DC and 300V DC. New...\$69.50

DYNAMOTOR. Navy Type CAJO-211444. 105/130V-DC to 13V DC at 40A or 26V DC at 20A. Radio filtered. Complete with Line Switch. \$69.50

DYNAMOTOR. Elicor. 32V DC to 110V AC, 60 cy. 1 Ph, 2.04 Amps. New...\$24.50  
 Also available for 64 volts input. Same price.

DYNAMOTOR. Elicor. 32V DC to 110V AC, 60 cy. 1 Ph, 0.43 Amps. New...\$17.50

DYNAMOTOR—Type PE94C. For use with SCR1522 Transmitter-Receiver. Brand new in export cases. \$9.50

AMPLIDYNE—G. E. Model 5AM21J7. 4600 R.P.M. Motor Compound wound. 150 Watts. Input: 27V. DC Output: 60V. DC Sig. Corps. U. S. Army MG-27-B. New...\$26.50

AMPLIDYNE—Edison type 5AM31N18A. Input: 27 volts 44 Amps., 8300 RPM. Output: 60V DC at 8.8 amps. 530 Watts. New...\$22.50

INVERTER—G. E. Model 5D-21N3JA. Input: 24V. DC, Output: 115V, 400 cy, 485 Va. New...\$49.50

INVERTER—Leland Elec. Co. Model PE206A. Input: 28V. DC, 38 Amps. Output 80V., 800 cy, 485 VA. New...\$17.50

PE 218 INVERTER—G. E. J8169172. Input: 28V. DC, Output: 115V, 400 cycles at 1.5 KVA...\$50.00

GENEMOTOR—Carter 6V DC to 400 V DC at 375 mils. New...\$49.50

D. C. MOTOR—G. E. Model 5BA 50L2A 0.5 HP. Armature: 27V. at 8.3 Amps. Field: 60V. at 2.3 Amps. R.P.M. 400. New...\$22.50

**Synchro Differential Generator**

Ford Inst. Co. Type 5SDG. Brand New...\$22.50

**WESTERN ELECTRIC CRYSTAL UNITS**

Type CR-1A/AR

Available in quantity—following frequencies

5910—6350—6370—6470—6510  
 6610—6670—6690—6940—7270  
 7350—7380—7390—7480—7580  
 9720—Kilocycles

Brand New \$1.29 each



**ELECTRONICRAFT INC.**

27 MILBURN ST. BRONXVILLE 8, N. Y.  
 PHONE: BRONXVILLE 2-0044

All merchandise guaranteed. Immediate delivery, subject to prior sale.  
 All Prices Subject to Change Without Notice



# Special Relays— OVER A MILLION IN STOCK!

Whether you require large quantities of relays for production runs or single units for laboratory or amateur work, Wells can make immediate delivery and save you a substantial part of the cost.

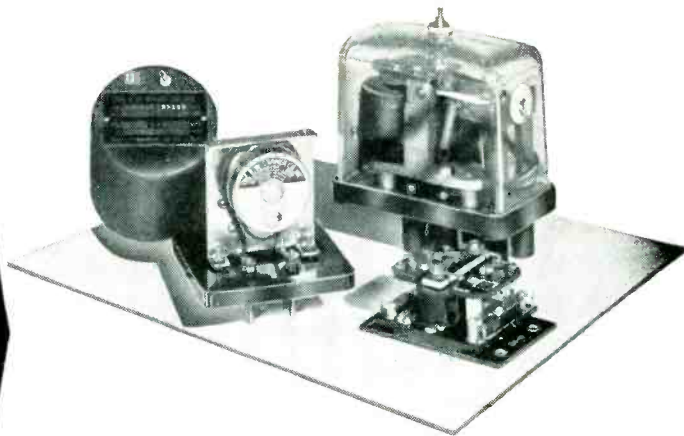

This list represents only a few types of Special Relays. We also have huge stocks of Standard D.C. Telephone Relays, Midget Relays, Contactors, Keying Relays, Rotary and Slow Acting Types as well as many others. Write or wire us about your requirements.

STOCK NO.	VOLTAGE	OHMS	CONTACTS	MANUFACTURER & NUMBER	PRICE
R-503	12/32 VDC.	100	3A, 2C	G.E. Ant. Keying 500W 2C6530-653A1	\$ 2.25
R-749	600 VDC.	...	Max. 28 Amps.	Allen Bradley 810 Dashpot	5.95
R-804	550 VAC.	...	1B/38 Amps.	Culter Hammer C-261173A34 Contactor	3.50
R-250	115 VAC.	...	Adj. Cir. Breaker .04-.16A	Westinghouse MN Overload	12.95
R-579	220 VAC.	...	1B	Adlake 60 Sec. Thermo Delay	6.95
R-294	27.5 VDC.	200	1B	Edison 50 Sec. Thermo Delay	4.25
R-686	115 VAC.	...	2C	Leach 1157T-5/20 Sec. ADJ. Delay	4.95
R-246	115 VAC.	...	1B	Cramer 2 Min. Adj. Time Delay	8.95
R-246A	115 VAC.	...	1A	Cramer 2 Min. Adj. Time Delay	8.95
R-611	24 VAC.	...	1A 30 Amps.	Durakool BF-63	4.25
R-283	12 VDC.	125	AC 10 Amps.	Onan Rev. Current 3H4512/R24	1.00
R-614	18 24 VDC.	60	1A 15 Amps.	Rev. Current Cutout 3H2339A/E1	3.50
R-262	12 VDC.	25	1C	W. U. Tel. Co. 41C Single Current	3.75
R-245	6 12 VDC.	50/50	4 In. Micalex Lever	.....	.95
R-527	12 24 VDC.	60/60	In Series	227668 For Scr-274N	.95
R-544	12 24 VDC.	60/60	1C	G.E. Push Button Remote Relay #CR2791-R-106C8	1.65
R-255	75 VAC.	400 CYC.	1A	G.E. Pressure Switch #2927B100-C2	.95
R-669	6 VDC.	...	1B, 1A	Clare 400	.95
R-660	24 VDC.	100	3/4" Stroke	Cannon Plunger Relay #13672	2.50
R-651	12 VDC.	275	Solenoid Valve	.....	2.15
R-295	12 VDC.	2	Annunciator Drop	Guardian Ratchet Relay	2.15
R-230	5 8 VDC.	12	2A, 1C	Ratchet Relay From Scr-522	4.25
R-813	12 VDC.	750	Wafer	Guardian BK-10	2.75
R-275	12 VDC.	70	1A, 1B, 1C	BK-13	1.45
R-716	24 VDC.	35	2A 5 Amps.	Guardian BK-16	1.05
R-620	6 12 VDC.	40	2C, 1A	Guardian BK-17A	1.25
R-629	9 14 VDC.	4500	1C 10 Amps.	Kurman BK-24	2.10
R-778	8 VDC.	50	1C 5 Amps.	45A High Power	1.35
R-720	24 VDC.	10/10	2C Ceramic	Str. Dunn. Latch & Reset	2.85
R-500	12 VDC.	10/15	2C 6 Amps.	Guardian Latch & Reset	2.85
R-816	12 VDC.	8000	2C 6 Amps.	Sigma 4R	1.65
R-811	48 VDC.	.....	1C	Edwards Alarm Bell	.95
R-524	24 VAC, DC.	925	2A	Allen Bradley-Bulletin #702	4.50
R-838	90, 120 VDC.	1200	3A	Motor Control	4.50
R-839	100, 125 VDC.	1200	2A	Allen Bradley-Bulletin #200E	4.50
R-840	115 VDC.	1200	4A	Motor Control	5.50
R-841	115 VDC.	925	3A	Allen Bradley-Bulletin #209 Size 1	25.00
R-842	115 VDC.	1200	3A	Motor Control W Type "N" Thermals	5.50
R-843	115 VDC.	1200	3A	Allen Bradley-Bulletin #709 Size 2	4.50
R-844	115 VDC.	1200	3A, 1B	Motor Control W Type "N" Thermals	4.50
R-845	220 VAC.	Intermit.	3A	Allen Bradley-Bulletin #709	4.50
R-831	7.5 29 VDC.	6.5	1A/250A, 1000A Surge	Motor Control	4.50
R-837	110 VAC.	2800	2A 30 Amps.	Allen Bradley-Bulletin #202	4.50
R-835	24 VDC.	2800	1A Dble. Brk./10 Amps.	Motor Control	4.50
R-836	220 VAC.	(Coil-only, Not a complete relay)	2A Ddle. Brk./10 Amps.	Allen Bradley-Bulletin #704	4.50
R-566	115 VAC.	150-Ohms. Coil Only	.....	Motor Control	4.50
R-710	.....	.....	.....	Leach B-8	3.50
				Leach 6104	2.75
				Wheelock Signal, B1/39	1.95
				Wheelock Signal, A7/37	3.45
				Leach #6104	.75
				Guardian #38187	.50

## Wide Selection of Electronic Components at WELLS

- Tubes
- Resistors
- Condensers
- Wire & Cable
- Volume Controls
- Co-ax Connectors
- Relays
- Rectifiers
- Transformers and Chokes
- Micro Switches and Toggles
- Antennas and Accessories
- Electronic Assemblies
- Dial Light Assemblies

## NOTICE!

Although our offices and showrooms were recently destroyed by fire, we are conducting business as usual from our new address.

Write For New Wells Catalog

Each relay is new, individually boxed, and unconditionally guaranteed by Wells

TELEPHONE: SEeley 8-4143

833 W. CHICAGO AVE., Dept. SL, CHICAGO 22, ILL.



**SYNCHROS**

G.E. 2J1F1	C-56701	C-78410
G.E. 2J1G1	C-69405-2	C-78411
G.E. 2J1H1	C-69406-1	C-78415
Connecting caps	C-78248	C-79331
C-4460A-2	C-78249	

Size 3, 5, 6, 7 synchro generators, motors, differentials, control transformers in stock.

**KOLLSMAN INSTRUMENT  
LOW INERTIA SERVO MOTORS**

Type 937-0240—85/68 Volts—100 Cycles  
2 Phase—5 Watts—2650 RPM  
Will Operate Satisfactorily at 60 Cycles  
Original Price \$34.50—

**\$12.95 EACH—Our Price**

**COAXIAL CONNECTORS**

83-1AC	.42	83-1J	.80	83-1T	1.12
83-1AF	.30	83-1R	.40	83-22AP	1.10
83-1F	1.30	83-1SP	.45	83-22R	.48
83-1H	.10	83-1SPN	.45	83-22SP	.85

**FULL LINE OF JAN APPROVED COAXIAL  
CONNECTORS IN STOCK**

UG-7	UG-23	UG-37	UG-102	UG-175	UG-236
UG-12	UG-24	UG-37	UG-103	UG-178	UG-234
UG-18	UG-27	UG-38	UG-104	UG-181A	UG-255
UG-19	UG-27A	UG-83	UG-106	UG-185	UG-264
UG-21	UG-29	UG-85	UG-108	MX-195	UG-274
UG-21B	UG-30	UG-86	UG-109	UG-197	UG-275
UG-22	UG-33	UG-87	UG-167	UG-201	UG-290
UG-22B	UG-34	UG-88	UG-171	UG-206	UG-306

M-358	MC-277	PL-259A	SO-239
M-359	MC-320	PL-274	SO-264
MC-359A	PL-258	PL-284	TM-201
N-360	PL-259	PL-293	

49120	D-163950	ES-685696-5
49121A	D-166132	ES-689172-1

**WESTINGHOUSE**

**HYPERSIL  
TRANSFORMER**

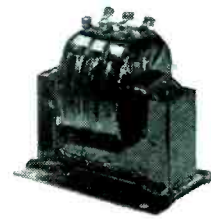

PRI-115V. 60CY 1/2 KVA  
SEC #1 - 240V - 1.56A  
SEC #2 - 240V - 1.56A  
WT. 30 LBS.

**\$14.50 EACH**

**GENERATORS**

• Eclipse-Pioneer type 716-3A (Navy Model NEA-3A)  
Output—AC 115V 10.4A 800 to 1400 cy. I φ: DC 30  
Volts 60 Amps. Brand New—Original Packing \$38.50

• Eclipse-Pioneer type 1235-1A. Output—30 Volts  
DC 15 Amps. Brand New—Original Packing...\$9.50

**STANDARD  
BRANDS ONLY**

**TUBE SPECIALS**

**BRAND NEW  
FIRST QUALITY**

**COMPLETE STOCK OF RECEIVING, TRANSMITTING, CATHODE RAY, THYRATRON,  
IGNITRON, MAGNETRON, KLYSTRON, PHOTOCCELL, T-R & ATR TUBES.  
QUOTATIONS UPON REQUEST**

**PULSE TRANSFORMERS**

Utah 9262	AN/APN-4 Block. Osc.
Utah 9340	Philco 352-7149
Utah 9278	Philco 352-7150
G.E. 68G828	Philco 352-7071
G.E. 68G-827	Philco 352-7178
G.E. K-2465A	Raytheon UX-7350
AN/APN-9 (901756-501)	W.E. D-161310
AN/APN-9 (901756-502)	W.E. D-163247
AN/APN-9 (352-7250)	W.E. D-163325
AN/APN-9 (352-7251)	W.E. D-164661

**SPRAGUE PULSE NETWORKS**

7.5 E3-1-200-67P, 7.5 KV, "E" Circuit 1 microsec.	
200 PPS, 67 ohms impd., 3 sections.	\$4.30
7.5 E3-3-200-67P, 7.5 KV, "E" Circuit 3 microsec.	
200 PPS, 67 ohms impd., 3 sections.	\$6.75
7.5 E4-16-60-67P 7.5 KV, "E" Circuit 4 sections,	
16 microsec, 60 PPS, 67 ohms impd.	\$8.25
15 E4-31-400-50P, 15KV "E" circuit .91 microsec.	
400 PPS, 50 ohms impd., 4 sections.	\$12.00

**MISCELLANEOUS EQUIPMENT**

ID-6/APN-4 Indicator	\$29.50
R-7/APS-2 Receiver	49.50
R-7B/APS-15 Receiver	49.50
SCR-522 Transceiver	36.95
RT-7/APN-1 Transceiver—less tubes	6.95
FL-8 1020 cycle filter	1.37
RM-29 remote control unit	8.95
RM-14 remote control unit	8.95
RTA-1B 12/24 V dynamotor	40.00
BC-1206-CM2 Receiver	7.95
CY-230/MPG-1 Radar Console	\$75.00
G.E. Type JP-1 portable current transformer	32.50
ASB-4 Radar equip. Complete	69.75
AN/APS-13 less tubes	12.95
T-9/APQ-2 less tubes	16.50
BC-645A complete	18.95
RCA AVR-15 Beacon Recvr.	15.50
TBY Trans-Recvr	29.95
T-17/ART-13 Transmitter	165.00
G.E. 2CV2AI Servo Amplifier	6.95
Sperry A-3 Hydraulic Servos	3.95
EIMAC 35 TG Ionization Gauge	5.95
ATR Inverters 6VDC to 110 VAC 60 cy 75W—Orig.	
Cartons	19.95
Pioneer Type 800-1B Inverters—28VDC to 120V 800 cy 7 amp AC (used)	22.65
G.E. Inverter—28VDC to 120VAC 800 cy 750VA 1 φ (new)	39.50
Navy SD-3 Radar complete	\$1208.00
Navy DP-14 complete	\$385.00

**SOUND POWERED TELEPHONES**

• U. S. INSTRUMENT Type A-260  
• WESTERN ELECTRIC Type D-173013  
• AUTOMATIC ELECTRIC Type GL-832BA0  
U. S. NAVY TYPE M HEAD AND CHEST SETS  
These are high quality heavy-duty units not to be confused with cheaper units now available. Designed to withstand exacting shock, vibration, salt water corrosion, temperature and pressure tests. ANY TYPE \$14.88 ea., \$28.00 per pair.  
TS-10 HANDSETS \$8.92 each

**METERS**

3 MA DC 2 1/2" R—Simpson black scale	\$3.35
300 Microamps, DC—2 1/4" round—Sun	\$4.30
1 ma, DC Fan type—4" scale (rem. from equlpt)	3.95
500 ma, DC 2 1/2" R—General Electric	2.95
2 amp, RF 2 1/2" Sq.—Simpson	3.15
5 amp, AC 4 1/2" R—JBT	4.11
50 VAC 3 1/2" R—General Electric	2.95
10 amp, RF 3 1/2" R—Simpson	4.95
50 amp AC 3 1/2" R—General Electric	4.11

**MAGNETRONS**

2J21A	\$9.95	2J39	24.50	700C	18.90
2J22	8.95	2J40	24.50	700D	18.90
2J26	7.80	2J41	132.50	706AY	45.00
2J27	13.70	2J48	14.95	706BY	45.00
2J31	19.90	2J49	39.50	706CY	26.95
2J32	19.90	2J61	45.20	706FY	45.00
2J33	19.90	4J50	197.00	706GY	45.00
2J34	19.90	4J52	197.00	714AY	6.95
2J36	85.00	5J23	14.20	720B/C/DY	
2J37	13.70	5J29	14.20	725A	75.00
2J38	12.70	7001B	18.90	730A	8.95

**KLYSTRONS**

2K23	\$37.50	2K33	295.00	707B	17.50
2K25	27.50	2K54	135.00	723A	6.95
2K28	27.50	2K55	135.00	723A/B	14.95
2K29	29.95	417A	10.65	726A	8.5J
		707A	7.22	5611J	135.00

**TYPE "J" POTENTIOMETERS  
\$1.25 each**

Resis.	Shaft	Resis.	Shaft	Resis.	Shaft
100	SS 10K	500	SS 10K	1000	SS 50K
200	SS 15K	650	SS 15K	1000	SS 50K
500	SS 15K	1000	SS 20K	1000	SS 100K
650	SS 20K	1500	SS 25K	1000	SS 100K
1000	SS 25K	1000	SS 30K	1000	SS 150K
10K	SS 30K	1 1/2"	1 MEG	SS	SS

Dual "JJ" Potentiometers—\$1.60 each  
50-50 Ω SS 100-100 Ω SS 250-250 Ω SS  
Triple 100K "JJ" Potentiometers—1 1/2" shaft—\$1.95  
All shaft lengths beyond bushing—SS (screw slot)

**TEST EQUIPMENT**

• A. W. Barber Labs. VM-25 VTVM	\$86.00
• TS-10A/APN Delay Line Test Set	45.00
• TS-1B/APQ.5 Calibrator	\$75.00
• REL W-1158 Frequency Meter 160-220 MC	\$32.95
• CWI-60AAG Range Calibrator for ASB, ASE, ASV and ASVC Radars	\$39.95
• CRV-14AAS Phantom Antenna for Transmitters up to 400 MC	\$117.75
• TS-148/AP X-Band Test Set	\$395.00
• TS-184/AP	\$60.00
• CPR-60AAJ and CPR-60AAK—IFF Test Sets, (pair)	\$16.95
• AN/APA-23 Recorder	\$147.50
• TN-1B/APR-1 Tuning Unit	\$95.00
• C-D Quietone Filter Type 1F-16 110/220 V AC/DC 20 Amps	\$9.00
• TS-127/U Freq. Meter w/spares	\$69.50
• TS-143/CPN Oscilloscope	\$95.00
• Dumont 175A Oscilloscope	\$225.00
• LM-20 Frequency Meter	\$49.50
• Gen. Radio 757-PI Power Supply	\$27.00
• Gen. Radio 670-F Decade	\$38.00
• I-130 A Signal Generator	\$70.00
• TS-6/AP Frequency Meter	\$42.00
• L & N KS-9470 Null Volt Test Set	\$60.00
• Measurements 79B Pulse Generator	\$200.00
• MIT TTX-10R8 3 cm FM Test Set	\$325.00

All Items New Except Where Noted (•) (Exc. Used Condition)

**HIGH VOLTAGE TRANSFORMERS**

G.E.—Pri. 115V 60 cy Sec. 6250V 80 MA—12.5 KV Ins.	\$18.50
G.E.—Pri. 115V 60 cy Sec. 6250/3850/2600V 56 MA 12.5 KV Ins.	\$18.50
Raytheon—Pri. 115V 60 cy Sec. 8500/6450V CT 43 MA Hermetically sealed	\$22.50

**CONSTANT VOLT. TRANSFORMERS**

Federal Constant Voltage Transformer Input 95-135V 60cy Output 115V 210W	\$34.00
Sola Constant Voltage Transformer Input 95-125V 60cy-Output 15.8V 285VA	\$24.70
Sola Constant Voltage Transformer Input 105-125V 60cy-Output 115V 80VA	\$15.95

**SELENIUM RECTIFIER STACKS**

**FULL WAVE BRIDGE**

MAXIMUM RATINGS AC VOLTS INPUT - 18 DC VOLTS OUT - 14.5	MAXIMUM RATINGS AC VOLTS INPUT - 40 DC VOLTS OUT - 34
1.2 Amps..... \$2.90	0.6 Amps..... \$3.30
2.4..... 3.38	1.2..... 3.78
4..... 4.50	3.2..... 5.66
6..... 4.44	6.0..... 10.25
17.5..... 9.56	9.0..... 11.05
26..... 16.86	12..... 20.50
39..... 25.30	18..... 22.13
52..... 33.74	24..... 39.56
65..... 42.26	36..... 45.36

**W. E. MERCURY CONTACT RELAYS**

Glass sealed mercury wetted SPDT contact assemblies. Magnetically operated. Used in Western Electric D-168479 high speed plug in relays. Supply your own coil \$2.00 each

**OIL FILLED CONDENSERS**

MFD	VDC	Price	MFD	VDC	Price
2	600	\$ .45	2	2000	\$2.70
4	600	1.05	4	2000	3.95
4	600 R'd	1.05	1	2500	.49
8	600 R'd	1.39	1-1	2500	3.85
10	600	1.95	32	2500	15.80
10	600 R'd	1.52	1	5000	4.88
8-8	6000	1.49	.01-.03	6000	1.65
1	1000	.62	1	7000	1.79
2	1000	.89	2	12500	28.95
3.5-5	1000	1.39	.045	16KV	4.70
1	1500	.89	.05	16KV	4.95
4	1500	2.95	.075	16KV	8.95
1-5	2000	.87	.25	20KV	18.95
.5	2000	.95	50	220VAC	3.95
1	2000	1.50	60	330VAC	5.75
			7	660VAC	3.35

**ANTENNAS**

AT-38A/APT (70 to 400MC)	\$13.70
AT-49/APR-4 (300 to 3300MC)	13.70
DZ-2 Loop antenna with pedestal	14.50
AN-74B (125 to 150MC)	1.65
AN-65A (P/O SCR-521)	.95
AN-66A (P/O SCR-521)	1.15
A1A—3CM conical scan	125.00
ASB Yagi—5 element 450 to 560MC	7.00
ASB Yagi—Double stacked 6 element	12.70
ASA Yagi—Double stacked 370 to 430MC	29.40

**COMPONENT SPECIALS**

FUSES	4AG	10 Amp.	\$3.00/c		
	4AG	20 Amp.	\$3.00/c		
<b>MOLDED PAPER CONDENSERS—</b>					
.02 MFD	200 VDC	\$4.50 per 100			
.05	200	4.50			
.1	200	5.00			
.1	400	9.00			
.005	600	4.50			
.01	600	8.00			
.05	600	9.00			
<b>CRYSTAL DIODES—</b>					
1N21	1.19	1N23	1.49	1N34	.79
1N21A	1.69	1N23A	2.55	1N45	.94
1N21B	3.25	1N23B	5.25	1N52	1.05
1N22	1.09	1N27	1.79	1N63	1.39

Terms 20% cash with order, balance C. O. D. unless rated. All prices F.O.B. our warehouse, Phila., Penna., subject to change without notice.

**LECTRONIC RESEARCH LABORATORIES**  
1021-A CALLOWHILL ST. PHILA. 23, PA.  
Telephones - MARKET 7-6590 and 6591



# Reliance Specials

## WIRE WOUND PRECISION RESISTORS 1% OR BETTER

1/4 WATT—30c			
6.68Ω	12.32Ω	16.37Ω	125Ω
10.48	13.02	62.54	147.5
10.84	13.62	79.81	220.4
11.25	13.89	105.8	301.8
11.74	14.98	123.8	366.6
1/2 WATT—30c			
.250Ω	1.53Ω	260Ω	4,000Ω
.334	2.04	270	4,451
.444	11.1	97.8	298.3
.602	13.15	100	400
.657	18.75	125	723.1
.827	46	180	2,500
.76	52	210	2,850
1.01	55.1	235	3,427
1 WATT—35c			
1.01Ω	3.39Ω	270Ω	7,000Ω
2.68	5.21	3,300	9,000
1 WATT—45c			
100,000Ω	128,000Ω	320,000Ω	800,000Ω
120,000	130,000	622,000	700,000

**1 Megohm—1 Watt 1%—65; 5%—45c**

**Wrapped—BALL BEARINGS—New**

Mfg	ID	OD	Width	Price
Fafnir 33K5	3/16"	1/2"	5/32"	\$0.25
MRC .205R	63/64"	2 3/64"	19/32"	1.10
N.D. 5202C13M	1/2"	1 3/8"	1/8"	1.00
Fafnir 7308W	1 37/64"	3 9/16"	5/16"	2.00
SKF46430	6"	8"	1"	5.00
TIMKEN	4 5/16"	6 1/4"	29/32"	4.25

**NEEDLE BEARINGS**

B108 1/2" wide	5/8"	13/16"	30¢
----------------	------	--------	-----

**ALLEN SET SCREWS**

4-40 x 1/8	8-32 x 1/8	8-32 x 5/16
4-40 x 3/16		8-32 x 3/8
ALL SIZES		\$1.50 per 100

**VERNIER DIAL or DRUM (From BC-221)**  
DIAL—2 3/4" dia. 0-100 in 360°. Black with silver marks. Has thumblock. DRUM—0-50 in 180°. Black with silver marks. \$1.50 each, either, 85¢

**BLOWER & MOTOR**  
Blower #1 1/2, motor 27 1/2 V.D.C., 1/100 H.P., 8,500 R.P.M. Continuous duty. Has mounting brackets. Navy Inspected \$3.50

**GEAR ASSORTMENT**  
100 small assorted gears. Most are stainless steel or brass. Experimenters dream!.....Only \$6.50

**UNIVERSAL JOINT**  
3/16" hole x 3/8" O.D.  
1 1/8" long  
Steel or Aluminum  
50¢

**2J1G1 SELSYNS**  
BRAND NEW  
400 Cycle  
Can be used on 60 cycle  
**\$1.95**

**DIFFERENTIAL**  
115 V., 60 Cyc.  
#C78249  
3 3/4" dia. x 5 3/8" long  
**\$3.95 ea.**

Used between two #C78248's as dampener. Can be converted to 3600 RPM Motor in 10 minutes. Conversion sheet supplied. (Converted).....\$4.50  
Mounting Brackets — (Bakelite) for selsyns, and differentials shown above.....35¢ pair

**FILAMENT TRANSFORMERS**  
Pri., 115V., 60 Cyc.—Secondary: { 6 V. @ 35 A.  
12 V. @ 18 A. **\$6.50**  
24 V. @ 9 A.

**PULSE TRANSFORMERS**  
**D161310**, 50 Kc to 4 Mc. 1 1/4" dia. x 1 7/8" high.  
120 to 2350 ohms..... **\$1.75**  
**KS9800**, Ratio, 1:1:1, 2:1. Freq. range 380 to 520 C.P.S..... **\$3.50**  
**D106173**, W.E. Freq. resp. 10KC to 2 MC.. **\$9.80**  
**800 KVA**, G.E. #2731, 28,000 Volt peak output:  
Bilar: one microsecond pulse width..... **\$37.50**

**WATER TIGHT JUNCTION BOX**  
14 gauge steel, 17"x25"x6 1/4", hinged lid, 2 access panels. Approx. wt. 50 lb.....\$3.50  
**VARIAC—General Radio**, 100 watts. Removed from equipment.....\$10.00

**PLUG IN CAPACITOR**  
8-8 MFD, 6,000 V.D.C.—Oil Filled. Plugs into standard 4 prong socket.....\$2.25

## CAPACITORS

### POSTAGE STAMP MICAS

MMF	MMF	MMF	MMF	MMF	MFD	MFD
8.2	43	100	250	580	0013	006
10	47	110	300	600	00136	0062
15	50	120	330	620	0015	0065
20	51	125	350	680	001625	0068
22	56	130	370	800	002	007
24	60	150	390	820	0026	0075
25	62	160	400	910	0027	008
26	75	175	430	MFD	003	0082
30	82	180	470	501	0033	.01
35	85	200	500	0011	0047	
39	90	220	510	.0012		
40		240	560			

**Price Schedule**

8.2 MMF to .001 MFD	5¢
.0011 MFD to .002 MFD	7¢
.0026 MFD to .0082 MFD	12¢
.01 MFD	22¢

**SILVER MICAS**

MMF	MMF	MMF	MMF	MMF	MFD	MFD
10	51	120	270	470	815	.00282
18	60	125	325	488	820	.002826
22	62	150	330	500	875	.003
23	68	180	360	510	MFD	.0033
24	68	200	370	525	.001	.0039
30	75	208	390	560	.001625	.005
39	82	225	400	660	.0022	.0051
40	100	240	410	700	.0023	.0056
50	110	260	430	750	.0024	.006
			466		.0028	.0082

**Price Schedule**

10MMF to .001MFD	10¢
.001625MFD to .0024MFD	20¢
.00282MFD to .0082 MFD	50¢

**OIL FILLED**

MFD	V. D. C.	Price	MFD	V. D. C.	Price
.25	20,000	\$16.75	1	1,000	\$1.39
.03	16,000	1.95	2	1,000	.80
.375 @	16,000 and	2	1	1,000	.65
.75 @	8,000	5.95	1	800	.39
.1	7,500	1.69	10	600	1.95
.1-1	7,000	1.69	8	600	1.60
.01	6,000	1.95	4	600	.98
.03-03	6,000	1.25	2	600	.45
.02-.02	7,000	1.25			
1	6,000	5.25			
2	5,000	4.50			
2	4,000	3.95			
2	3,000	2.15			
.25	3,000	1.10			
4	750 AC	.49			
8	2,000	3.95			
2	2,000	3.65			
2	2,500	1.95			
1	2,000	.95			

**2 mfd 4,000 V.D.C. SPECIAL \$3.95**

**CERAMICONS**

5 M MFD	30 M MFD	500 VOLT CERAMIC CONDENSERS
2	35	2 18 56 150
12	45	3 44 22 62 180
15	62	4 7 27 68 200
20	82	8 30 82 220
22	110	12 33 91 270
	150	13 40 100 300
	200	15 47 140 1000

**SOUND POWERED HANDSET**  
Brand New!  
Includes 6 ft. cord. No batteries or external power source used.  
\$8.92 ea. \$17.60 pr.

**TIME DELAY RELAY**  
Raytheon CPX 24166 KS 10193-60 Sec.  
• 115 V., 60 Cycle • Adj. 50-70 Seconds •  
2 1/2 second recycling time—spring return •  
Micro-switch contact, 10A • Holds ON as long as power is applied • Fully cased •  
**ONLY \$6.50**

**PRECISION CONTROLS**

6 WATT	4 WATT
20,000Ω Muter 314A \$1.70	5K De jur 296 \$1.50
6,000 De jur 260 1.70	500Ω Centralab 48-501 1.00
6,000 Muter 314A 1.70	200Ω GR 301 1.25
5,000 Muter 314A 2.50	12 GR 301 1.10
2,000 De jur 260 1.70	12 De jur 292 1.00
10,000 De jur 271T \$2.00	12 De jur 292 1.00
10,000 Muter 471A 2.00	2 GR 301 1.25
5,000 De jur 271T 2.00	

**PRECISION CAPACITOR—W.E.**  
D-161270, 1 mfd @ 200 VDC; -40° to +65°C.....\$8.50

**SELENIUM RECTIFIERS**  
Full Wave—200 ma., 115 V.....\$1.79  
Half Wave—100 ma., 115 V......79

## COAXIAL CABLES

GUARANTEED!! NEW!!

	Price per Ohms 1,000 ft		Price per Ohms 1,000 ft
RG-6/U	76 \$150	RG-29/U*	53.5 \$50
RG-7/U*	97.5 65	RG-34/U	71 175
RG-15/U	76 160	RG-35/U	71 450
RG-21/U	93 110	RG-37/U	55 40
RG-22/U*	55 110	RG-39/U	67.5 180
RG-24/U	125 240	RG-41/U	72.5 550
RG-25/U	48 575	RG-51/U	53 65
RG-26/U	48 75	RG-55/U	53.5 65
RG-27/U	48 290	RG-57/U*	95 100
		RG-58/U*	53.5 60
		RG-77/U*	48 100
		RG-78/U	48 80

\*No minimum order—others 250' minimum  
Add 25% for orders less than 1,000 feet

## COAXIAL CABLE CONNECTORS

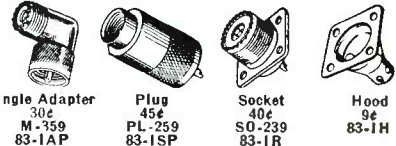

Adapter for PL-259 A for use on small coax. \$10.00 per 100 12c each

Angle Adapter	Plug	Socket	Hood
30c	45c	40c	9c
M-359	PL-259	S0-239	83-1H
83-1AP	83-15P	83-1R	

UG-19/U .73 UG-85/U .88  
UG-21/U .67 UG-87/U .79  
UG-103/U .88  
UG-104/U .45  
UG-107/U 2.00  
UG-124/U .67 UG-171/U 1.33  
UG-175/U .15  
UG-176/U .15  
UG-197/U 1.33  
UG-206/U .63  
UG-205/U 1.22  
UG-34/U 14.80 UG-206/U 1.74  
UG-36/U 12.80 UG-281/U .60  
UG-37/U 12.80  
UG-38/U .63

## JONES BARRIER STRIPS

Type	Price	Type	Price	Type	Price
2-140Y	\$0.13	5-141	.26	17-141Y	1.17
3-140 3/4 W	.21	5-141 3/4 W	.37	3-142	.21
5-140	.21	6-141Y	.37	3-142Y	.29
6-140	.25	7-141	.36	5-142 3/4 W	.46
10-140 3/4 W	.53	7-141 3/4 W	.49	11-142Y	.95
2-141	.13	8-141Y	.58	2-150	.39
3-141 3/4 W	.24	9-141 3/4 W	.64	2-150 3/4 W	.47
3-141W	.14	9-141Y	.64	3-150	.54
4-141W	.30	10-141Y	.71	4-150	.70
4-141 3/4 W	.30	13-141 3/4 W	.89		

## DELAY NETWORK—ALL 1400Ω

T 113—Approx. 1.2 micro sec. delay.....	} 95¢ each
T 114—Approx. 2.2 micro sec. delay.....	
T 115—Similar to T 114 with tap brought out	

## CHOKES

30 Henry 80 ma.....	\$1.29
6 Henry 80 ma.....	.79

## 3AG FUSES

AMP	Per 100	AMP	Per 100	AMP	Per 100
1/4	\$4.00	3/4	\$4.00	6	\$3.00
1/2	4.00	2	3.00	10	3.00
3/4	4.00	3	3.00	15	3.00
1	4.00	5	3.00	20	3.00

Fuse Holder—for 3AG Fuse. (Littlefuse or Buas).....25c

## 4AG FUSES

AMP	Per 100	AMP	Per 100	AMP	Per 100
1/8	\$4.00	2	\$2.00	10	\$2.50
1/4	3.50	3	2.00	15	2.50
1/2	3.50	3.2	2.00	25	2.50
1	2.00	5	2.00		

Fuse Holder—For 4AG Fuse. (Littlefuse).....25c

## Brand New METERS—Guaranteed

0-1 Amp. R.F.	2 3/4"	\$3.29
0-300 V.D.C.	2 3/4"	3.50
0-80 Amp. D.C.	2 3/4"	2.25
0-7.5 V. A. C.	3 1/2"	3.46

## AN CONNECTORS

IMMEDIATE SERVICE  
PHONE! WIRE! WRITE! YOUR NEEDS

BC 348—H, J, L, O, P, Q, S—write for prices

POSTAGE STAMP MICA ASST.—100 pcs. including some silver micas.....\$3.29

CARBON MIKE—T-17, slightly used, guaranteed. Has 5 foot cord and PL68.....89¢

THROAT MIKE—MT 81-A—2 mikes in leather zipper case with 56" cord & PL68—Brand New.....59¢

SPAGHETTI SLEEVEING—assortment—99 feet.....\$1.00

Minimum Orders \$3..... All orders f.o.b. PHILA, PA.

# RELIANCE MERCHANDIZING CO.

Arch St. Cor. Croskey Phila. 3, Pa. Telephone Rittenhouse 6-4927



1000 KC crystal BT cut.....\$3.95  
 3" scope shield.....1.29  
 2 speed dial drive for 1/4" shaft ratios 5:1 1 to 1 .39  
 ATC 100 mmfd air trimmer screwdriver shaft......29  
 Sigma Sens. Relay 8000 ohms.....1.98  
 Centralab 850 S 50MMF 5KV BUTTON COND.....39  
 500 watt 12.5 ohm power rheostat.....3.49



50 mmfd 5 KV vacuum condenser.....\$1.49  
 6v. 12v vibrators any type......98  
 Rotary switch Mycalex, 2 deck SP3T......39  
 1 mfd 5000v oil condenser.....2.98  
 2 mfd 3000v oil condenser.....3.25  
 3 mfd 4000v oil condenser.....3.95  
 24 mfd 1500v DC 3KV flash. Excellent for speed lamp.....3.95

**TUBES!! BRAND NEW! STANDARD BRANDS! NO SECONDS! COMPARE! TUBES!!**

0A3 VR75 \$1.29	3C23 \$ 9.95	204A \$69.50	809 \$ 2.45	8012 \$ 3.95	0A2	6SN7GT	12S17
0B3 VR90 1.29	3C24 2.46	211 .69	810 .95	8013 2.95	0A1G	6B3	12K7
0C3 VR105 1.49	3C30 2.95	212E 49.50	811 2.95	8014 29.95	0B2	6B4	12S17
0D3 VR150 1.29	3C31/C1B 3.49	215A .99	2.95	8015 1.29	0Z4	6A7	12S17
1B23 3.45	3C45 12.75	217C 8.95	6.90	8023 5.95	01A	6A8	12S17
1B23 12.50	3CP1 2.25	227A/5C27 5.95	8.95	9001 2.25	1A3	6A8	12S17
1B24 3.95	3CP1-S1 2.95	230C 3.95	8.14	9002 1.49	1A4P	6A8	12S17
1B26 3.95	3DP1 4.95	230R 12.95	8.15	9003 1.49	1A5GT	6A8	12S17
1B27 24.50	3DP1A 6.95	250TH 21.50	2.95	9004 .45	1A6	6A8	12S17
1B29 3.95	3DP1-S2A 14.95	250TL 21.50	2.95	9005 1.49	1A7GT	6A8	12S17
1B32 8.95	3D21A 1.98	271A 5.50	2.95	9006 .29	1A85	6A8	12S17
1B36 24.96	3E29 14.95	274B 2.65	8.29	9007 1.49	1B3/8016	6A8	12S17
1B38 32.50	3EP1 5.95	276A 2.98	8.29	9008 1.49	1B4	6A8	12S17
1N21 Xtal 1.25	3EP1A 4.95	283A 2.98	8.29	9009 1.49	1B5/25S	6A8	12S17
1N21A Xtal 2.25	3GP1 4.75	291A 5.75	8.29	9010 1.49	1B7GT	6A8	12S17
1N21B Xtal 3.25	3HP7 3.95	300B 9.95	8.29	9011 1.49	1C5GT	6A8	12S17
1N22 Xtal 1.25	4-1P4A 14.95	301TL 29.95	8.29	9012 1.49	1C6	6A8	12S17
1N23 Xtal 2.25	4-125A 26.95	304TL 29.95	8.29	9013 1.49	1C7G	6A8	12S17
1N23A Xtal 3.25	4-250A 29.95	305A 34.95	8.29	9014 1.49	1D5GP	6A8	12S17
1N23B Xtal 4.25	4AP10 4.95	307A/RK75 5.95	8.29	9015 1.49	1E7G	6A8	12S17
1N27 1.69	4R22/EL5B 9.95	310A 8.95	8.29	9016 1.49	1E8GT	6A8	12S17
1N34 1.05	4R24/EL3C 7.95	316A .65	8.29	9017 1.49	1E9GT	6A8	12S17
1N34A 1.05	4R25/GCF 8.95	323A/B 24.50	8.29	9018 1.49	1F4	6A8	12S17
1P23 1.79	4B26/2000 8.95	327A/5C37 4.95	8.29	9019 1.49	1F5G	6A8	12S17
1P24 2.95	4B28 4.95	328A 13.95	8.29	9020 1.49	1F6GT	6A8	12S17
1P26 2.95	4AP10 4.95	330A 8.95	8.29	9021 1.49	1F7G	6A8	12S17
1P27 1.95	4C27 9.95	330A 8.95	8.29	9022 1.49	1F8GT	6A8	12S17
2AP1 8.95	CV92 49.50	330B 2.95	8.29	9023 1.49	1F9GT	6A8	12S17
2AP5 6.95	4C35 29.50	368AS 7.95	8.29	9024 1.49	1G4GT	6A8	12S17
2C21/RK33 12.95	4D32 12.95	371A 1.49	8.29	9025 1.49	1H5GT	6A8	12S17
2C22/7193 4.9	4D32 14.95	371B .98	8.29	9026 1.49	1H6GT	6A8	12S17
2C26A 4.9	4E27 7.95	388A 6.95	8.29	9027 1.49	1J6GT	6A8	12S17
2C26B 4.9	4E27 7.95	388B 6.95	8.29	9028 1.49	1L4	6A8	12S17
2C26C/RK34 4.9	5-2B 17.95	388A/R 1.39	8.29	9029 1.49	1L4	6A8	12S17
2C39 24.50	5AP1 3.69	391A 4.95	8.29	9030 1.49	1L6	6A8	12S17
2C40 4.95	5AP4 3.69	417A 12.95	8.29	9031 1.49	1L6	6A8	12S17
2C43 1.49	5BP1 5.95	417A 12.95	8.29	9032 1.49	1L6	6A8	12S17
2C44 1.49	5BP1 5.95	446A 4.95	8.29	9033 1.49	1L6	6A8	12S17
2C46 7.50	5CP1 4.95	446B 4.95	8.29	9034 1.49	1L6	6A8	12S17
2C51 5.75	5CP7 4.95	450TH 4.75	8.29	9035 1.49	1L6	6A8	12S17
2D4 1.95	5C22 49.55	450TL 44.50	8.29	9036 1.49	1L6	6A8	12S17
2E22 1.95	5D21 24.50	527 12.75	8.29	9037 1.49	1L6	6A8	12S17
2E24 4.89	5D21 24.50	527 12.75	8.29	9038 1.49	1L6	6A8	12S17
2E26 3.69	5D21 24.50	527 12.75	8.29	9039 1.49	1L6	6A8	12S17
2E30 2.29	5GP1 4.95	562 97.50	8.29	9040 1.49	1L6	6A8	12S17
2E32 1.95	5P1 24.45	575A 13.95	8.29	9041 1.49	1L6	6A8	12S17
2E34 4.89	5P4 24.45	701A 1.39	8.29	9042 1.49	1L6	6A8	12S17
2F21A 9.95	5J23 12.95	702A 3.95	8.29	9043 1.49	1L6	6A8	12S17
2F22 2.95	5J29 12.95	703A 7.95	8.29	9044 1.49	1L6	6A8	12S17
2F26 2.95	5J30 12.95	704A 1.05	8.29	9045 1.49	1L6	6A8	12S17
2F27 2.95	5J30 12.95	704A 1.05	8.29	9046 1.49	1L6	6A8	12S17
2F30 3.95	5P1 13.95	706B 39.50	8.29	9047 1.49	1L6	6A8	12S17
2F31 3.95	5P1 13.95	706B 39.50	8.29	9048 1.49	1L6	6A8	12S17
2F32 3.95	5P1 13.95	706B 39.50	8.29	9049 1.49	1L6	6A8	12S17
2F33 3.95	5P1 13.95	706B 39.50	8.29	9050 1.49	1L6	6A8	12S17
2F34 3.95	5P1 13.95	706B 39.50	8.29	9051 1.49	1L6	6A8	12S17
2F36 97.50	6P4 5.95	707B 17.95	8.29	9052 1.49	1L6	6A8	12S17
2F37 12.75	6P4 5.95	708A 4.95	8.29	9053 1.49	1L6	6A8	12S17
2F38 3.95	7BP7 8.95	709A 3.95	8.29	9054 1.49	1L6	6A8	12S17
2F39 3.95	9GP7 14.95	710A/8011 1.75	8.29	9055 1.49	1L6	6A8	12S17
2F40 3.95	9P1 14.95	713A 1.63	8.29	9056 1.49	1L6	6A8	12S17
2F41 3.95	9P1 14.95	713A 1.63	8.29	9057 1.49	1L6	6A8	12S17
2F42 3.95	9P1 14.95	713A 1.63	8.29	9058 1.49	1L6	6A8	12S17
2F43 3.95	9P1 14.95	713A 1.63	8.29	9059 1.49	1L6	6A8	12S17
2F44 3.95	9P1 14.95	713A 1.63	8.29	9060 1.49	1L6	6A8	12S17
2F45 3.95	9P1 14.95	713A 1.63	8.29	9061 1.49	1L6	6A8	12S17
2F46 3.95	9P1 14.95	713A 1.63	8.29	9062 1.49	1L6	6A8	12S17
2F47 3.95	9P1 14.95	713A 1.63	8.29	9063 1.49	1L6	6A8	12S17
2F48 3.95	9P1 14.95	713A 1.63	8.29	9064 1.49	1L6	6A8	12S17
2F49 3.95	9P1 14.95	713A 1.63	8.29	9065 1.49	1L6	6A8	12S17
2F50 3.95	9P1 14.95	713A 1.63	8.29	9066 1.49	1L6	6A8	12S17
2F51 3.95	9P1 14.95	713A 1.63	8.29	9067 1.49	1L6	6A8	12S17
2F52 3.95	9P1 14.95	713A 1.63	8.29	9068 1.49	1L6	6A8	12S17
2F53 3.95	9P1 14.95	713A 1.63	8.29	9069 1.49	1L6	6A8	12S17
2F54 3.95	9P1 14.95	713A 1.63	8.29	9070 1.49	1L6	6A8	12S17
2F55 3.95	9P1 14.95	713A 1.63	8.29	9071 1.49	1L6	6A8	12S17
2F56 3.95	9P1 14.95	713A 1.63	8.29	9072 1.49	1L6	6A8	12S17
2F57 3.95	9P1 14.95	713A 1.63	8.29	9073 1.49	1L6	6A8	12S17
2F58 3.95	9P1 14.95	713A 1.63	8.29	9074 1.49	1L6	6A8	12S17
2F59 3.95	9P1 14.95	713A 1.63	8.29	9075 1.49	1L6	6A8	12S17
2F60 3.95	9P1 14.95	713A 1.63	8.29	9076 1.49	1L6	6A8	12S17
2F61 3.95	9P1 14.95	713A 1.63	8.29	9077 1.49	1L6	6A8	12S17
2F62 3.95	9P1 14.95	713A 1.63	8.29	9078 1.49	1L6	6A8	12S17
2F63 3.95	9P1 14.95	713A 1.63	8.29	9079 1.49	1L6	6A8	12S17
2F64 3.95	9P1 14.95	713A 1.63	8.29	9080 1.49	1L6	6A8	12S17
2F65 3.95	9P1 14.95	713A 1.63	8.29	9081 1.49	1L6	6A8	12S17
2F66 3.95	9P1 14.95	713A 1.63	8.29	9082 1.49	1L6	6A8	12S17
2F67 3.95	9P1 14.95	713A 1.63	8.29	9083 1.49	1L6	6A8	12S17
2F68 3.95	9P1 14.95	713A 1.63	8.29	9084 1.49	1L6	6A8	12S17
2F69 3.95	9P1 14.95	713A 1.63	8.29	9085 1.49	1L6	6A8	12S17
2F70 3.95	9P1 14.95	713A 1.63	8.29	9086 1.49	1L6	6A8	12S17
2F71 3.95	9P1 14.95	713A 1.63	8.29	9087 1.49	1L6	6A8	12S17
2F72 3.95	9P1 14.95	713A 1.63	8.29	9088 1.49	1L6	6A8	12S17
2F73 3.95	9P1 14.95	713A 1.63	8.29	9089 1.49	1L6	6A8	12S17
2F74 3.95	9P1 14.95	713A 1.63	8.29	9090 1.49	1L6	6A8	12S17
2F75 3.95	9P1 14.95	713A 1.63	8.29	9091 1.49	1L6	6A8	12S17
2F76 3.95	9P1 14.95	713A 1.63	8.29	9092 1.49	1L6	6A8	12S17
2F77 3.95	9P1 14.95	713A 1.63	8.29	9093 1.49	1L6	6A8	12S17
2F78 3.95	9P1 14.95	713A 1.63	8.29	9094 1.49	1L6	6A8	12S17
2F79 3.95	9P1 14.95	713A 1.63	8.29	9095 1.49	1L6	6A8	12S17
2F80 3.95	9P1 14.95	713A 1.63	8.29	9096 1.49	1L6	6A8	12S17
2F81 3.95	9P1 14.95	713A 1.63	8.29	9097 1.49	1L6	6A8	12S17
2F82 3.95	9P1 14.95	713A 1.63	8.29	9098 1.49	1L6	6A8	12S17
2F83 3.95	9P1 14.95	713A 1.63	8.29	9099 1.49	1L6	6A8	12S17
2F84 3.95	9P1 14.95	713A 1.63	8.29	9100 1.49	1L6	6A8	12S17
2F85 3.95	9P1 14.95	713A 1.63	8.29	9101 1.49	1L6	6A8	12S17
2F86 3.95	9P1 14.95	713A 1.63	8.29	9102 1.49	1L6	6A8	12S17
2F87 3.95	9P1 14.95	713A 1.63	8.29	9103 1.49	1L6	6A8	12S17
2F88 3.95	9P1 14.95	713A 1.63	8.29	9104 1.49	1L6	6A8	12S17
2F89 3.95	9P1 14.95	713A 1.63	8.29	9105 1.49	1L6	6A8	12S17
2F90 3.95	9						



# NOBODY UNDERS SELLS NIAGARA CHECK THESE GUARANTEED VALUES!

"ONE OF AMERICA'S GREAT ELECTRONICS STORES"

### METER BARGAINS

3 SQ. Supreme	542	Multimeter	\$3.75
3 SQ. RCP	446	Multimeter	3.75
3 SQ. Hitchcock	0-200	Microamps	6.50
3 RD. Asst'd	0-200	Microamps	6.50
3 RD. Triplet	0-500	Microamps	6.25
3 RD. Weston	0-100	Thermo-Galvanometer	10.00
3 RD. Weston	0-120	Galvanometer	9.80
3 RD. Asst'd	0-1	MA.	4.95
3 RD. Asst'd	0-100	MA.	3.95
3 RD. Weston	0-150	MA.	3.95
3 SQ. Asst'd	0-150	MA.	3.95
3 RD. Asst'd	0-300	MA.	3.95
3 RD. G. E.	0-500	MA.	3.95
3 RD. Weston	0-8	A. C. Volts	3.75
3 RD. G. E.	0-10	A. C. Volts	3.75
3 SQ. West' hse	0-10	A. C. Volts	3.85
2 RD. West' hse	0-15	A. C. Volts (600 cy.)	2.49
3 RD. West' hse	0-150	A. C. V.	3.95
3 SQ. Marion	0-150	D. C. V.	3.95
3 RD. G. E.	0-350	D. C. V.	3.95
3 RD. Asst'd	0-500	D. C. V.	3.95
3 SQ. Simpson	0-1000	D. C. V.	3.95
3 RD. Asst'd	0-1.5	D. C. K. V.	3.49
3 RD. West' hse	0-3.5	D. C. K. V.	3.49
3 RD. F. E.	0-30	D. C. K. V.	3.49

(AMMETER PRICES ON REQUEST)

### OIL FILLED CONDENSERS

All Brand New—Leading Brand Names

CAP.	D. C. Volts	No.	Net Each
.005	15,000	14F322	\$7.95
.005-.005-.01	10,000	26FH16g2	10.50
.035	10,000	AX1U36	7.50
.02	15,000	14F321	21.95
.01	6,000	143-506	
.15	2,500	26F345	1.10
.2	5,000	C8B2784	2.98
.25	4,000	P9717	3.10
.25	10,000	14F192	19.50
.6	2,500	72041-503	1.25
1	440 AC	KG4010	.59
2	2,500	482616-10	2.55
1	3,000	A1089	2.75
1	3,600	C8B3062	2.95
1	5,000	23F49-G2	3.15
1	6,000	60010GA	4.35
1	12,000	26F628	9.50
2	440 AC	67 x 21	.79
2	600	A14109-2	.85
2	1,000	23F11	1.10
2	2,000	324-138	2.20
2	3,000	2538-16	4.50
2	5,000	C-8B2784	6.50
2.5-2.5-5	600	C8B1256	1.95
4	330 AC	KG3040	.85
4	400	25F785	.95
4	600	B8B1253-1	1.10
4	1,000	10365	1.75
5	1,000	13765	1.85
6	330 AC	67 x 7A	.89
6	44 AC	K64060	.95
6	600	P971S	1.75
8	1,000	143-117	2.50
8	2,000	TJU20080G	4.95
10	400	7DB1AE1D	1.25
10	600	10373	1.85
15	1,000	23F19G2	3.95

**MORE OUTSTANDING BARGAINS**  
IN OUR NEW FLYER

WRITE FOR YOUR FREE COPY

### IMPORTANT NOTICE:

Minimum Order \$5. Quantity prices on request. All items in stock now—subject to prior sale—prices subject to change without notice. 20% Deposit with orders unless rated. All prices F.O.B. our N. Y. C. Warehouse.

### 70% OFF LIST POPULAR SPLIT-STATORS

### VARIABLE CONDENSERS

Popular Split Stator Variables at unbelievable low Prices! Well Built, low loss ceramic mounted with bushings at both rotor ends. Ideal for V. F. O., low powered rig and exciter units, receivers, etc. All with 1/4" Shafts.

CAPACITY	LIST PRICE	YOUR COST
15-15	\$3.80	\$1.14
20-35	3.95	1.19
27-27	4.10	1.23
35-35	4.30	1.39
75-75	4.80	1.44

## TUBES

**NEW—BRANDED  
GUARANTEED  
LARGE QUANTITIES**  
RECEIVING—TRANSMITTING  
INDUSTRIAL

PRICES ON REQUEST

### EQUIPMENT SPECIALS

ALL QUANTITIES LIMITED

Ferris 18c Sig. Gen. L.N.	\$499.95
Bendix Ta-12c Exc.	39.95
BC733D Vy Good	14.95
ATA-CBY-52232 2.1-3 Xmtr—New	14.95
BC-652A 2-6 Mc Rcvr. New	39.95
DM40A 12 V. Dyn. for Above. New	4.95
DM42A Xmtr Dyn. Oversea Crated. New	19.95
Sig. Gen. I-126. Vy. Gd.	125.00
RS25-3 Rcvr. Vy. Gd.	29.95
BC-605D Amplifier—New	5.95
AVT-23 Transmitter—New	34.95
ID-93/APG-13A Scope. New	39.95
SCR-522 ("C" Rcvr.). Vy. Good	75.00
PE-103. Exc.	24.95
PE-103 Connecting Cables	4.95
ART-13. Exc.	175.00
BC-221 Freq. Mtr. Exc. Cond.	75.00
ATD Xmtr. New	49.95
Dyn. for Above	24.95
ATD Spare Parts Kit	19.95
BC 906c Freq. Mtr.	32.50
GYRO FLUX GATE Comp. Amplif. New	14.95
BC 439 Freq. Meter	19.95

### SMASHING VALUES IN BLOWERS

(A)—**DUAL BLOWER**, approximately 100 cu. ft., per min., per section. Constant duty 110 V. A. C. 60 cycle, 3400 RPM motor made by HEINZE. 2 1/2" intake, 2" outlet. Measures 6" high x 6 1/2" deep x 10 1/2" long. NEW—BOXED. .... \$14.95

(B)—**SINGLE SECTION BLOWER**, Approximately 100 cu. ft., per min. Constant duty 110 V. A. C. 25 and 60 cy., 3200 RPM HEINZE MOTOR. 2 1/2" intake, 2" outlet measures 6" high x 6 1/2" deep x 6" long. NEW—BOXED. .... \$9.95

(C)—**SINGLE SECTION BLOWER**, Approximately 50 cu. ft., per min. Air cooled 110 V. A. C. 60 cycle F. A. SMITH MOTOR. 2" intake, 1 1/2" outlet. Measures 5" high, 4" deep, 5" long. NEW—BOXED. .... \$6.95

(D)—**SINGLE SECTION BLOWER**, Approximately 50 cu. ft., per min. Constant duty 24 V. D. C. 6000RPM A. G. REDMOND CO., MOTOR. 2" intake by 1" outlet. Measures 3 1/2" high, 3" deep, 5" long. NEW SURPLUS SPECIAL. .... \$3.95

### AIRCRAFT TYPE

Vibrator power supply delivering 300 V. D. C. at 80 Ma. Filter Built-in, fully wired, tested and guaranteed **\$5.95** new

### TRANSFORMER BARGAINS!

#### Plate

1025-0-1025-500 MA	\$17.95
2500 V.—4 MA.	3.95

#### Filament

2.5V.10A cased	4.95
5 V.C.T.-3A	
5 V.C.T.-10.5A	3.95
6.3 V.C.T.-3.5A	
5V-10A	1.85
5 V.C.T.-15A	5.95
6.4V-8A	2.05
7.5V-5A	2.49

#### Power

275-0-275-70 MA.—5V-5A, 2.5V-10.5A	3.00
325-0-325-40 MA.—5 V.C.T.-2A, 2.5 V.C.T.-4A	2.25
325-0-325-70 MA.—6.3V-1.2A, 5V-3A	2.95
350-0-350-100 MA.—6.3V-6A, 6.3V-2A	3.25

#### Modulation

807 to P.P. 6L6	\$2.49
P.P. 807 to single 6L6, 4D32 (2400 ohms)	3.49
From 200, 500 ohms to 5, 6, 7, 8, 9, 10K ohms at 150 MA.	4.49

#### Driver Xfmrs.

200, 10,000 ohm P. to single G.	\$ .79
10,000 ohm P. to single G.	.80
P.P. 45, 2A3, etc. to P.P. 210, 801, etc.	1.95
P.P. 6L6, 2A3, etc. to P.P. grids	1.65

#### Output

6V6 to 2, 4, 8 ohms	.69
P.P. par 6N7 Class "B" to 8000 ohms	1.49

#### Input

600 ohm C.T. to 300 ohm mlke	\$1.49
------------------------------	--------

#### Mike to Line

From and to 50, 125, 200, 330, 500 Ohms	\$2.49
30 ohm mlke to 600 ohm C.T. Bal. line.	1.65

#### Chokes

.875	HY.	2.5 Amps	8.95
2.5	HY.	4 Amps	9.95
2.5	HY.	130 MA.	1.10
4	HY.	40 MA.	.25
8	HY.	200 MA.	2.35
10	HY.	180 MA.	3.49
40	HY.	90 MA.	3.49
10	HY.	200 MA.	2.49
12	HY.	150 MA.	1.75
15	HY.	125 MA.	1.60
15	HY.	200 MA.	2.65
20	HY.	125 MA.	1.75



**Niagara Radio Supply Corp.**  
Dept. E-31 160 Greenwich Street, New York 6, N. Y.  
Phone Dlgby 9-1132-34

# SURPLUS NEW PANEL METERS - IN STOCK

## A. C. VOLTMETERS

- 15 Volts, Westinghouse NA-35, 3/4" Round flush bakelite (JAN type MR35W15ACV) @ \$5.50
- 15 Volts, General Electric AW-41, 2 1/2" Round flush bakelite, bl. scale with markings & calib. at 0, 10 & 15 only. Signal Corps Stock IS-122... @ \$3.00
- 15 Volts, General Electric AW-41, 2 1/2" Round flush bakelite, black scale, red mark at 10 Volts, calib. for 800 cycles... @ \$3.00
- 40 Volts, Westinghouse NA-33, 2 1/2" Round flush metal case, black scale lum. markings, calib. for 400 cycles... @ \$3.50
- 40 Volts, Westinghouse NA-33, 2 1/2" Round flush metal case, black sc. lum. markings. (These were originally calib. for 400 cycle use but have been adj. for 60 cycle) @ \$3.95
- 40 Volts, Weston 517, 2 1/2" Round flush metal case, black scale lum. markings, calib. for 400 cycles... @ \$3.50
- 75 Volts, Weston 517, 2" Round flush metal case, ring-clamp type mtg. non-flanged... @ \$2.95
- 150/300 Volts, Dual Range, Triplett 331-JP, 3 1/2" Round fl. bakelite case with external series res. for 300 volts, sc. calib. 150 double scale indications for 300 volt use... @ \$6.00

## R. F. AMMETERS

- 120 MA Simpson 125, 3/4" Round flush bakelite, arbitrary linear scale calib. 0-10 with caption Output Units, internal thermocouple... @ \$7.50
- 1 Amp, G.E. DW-52, 2 1/2" Round fl. bakelite case @ \$4.50
- 1 Amp, G.E. DO-44, 3 1/2" Round fl. bakelite case @ \$11.00
- 1.5 Amp, Weston 507, 2 1/2" Round flush metal, black scale @ \$4.50
- 1.5 Amp, General Electric DW-52, 2 1/2" Round flush metal, black scale @ \$3.50
- 2 Amps, Simpson 137, 2" Square flush bakelite case @ \$4.50
- 2 Amps, Weston 425, 3 1/2" Round flush bakelite @ \$8.50
- 2.5 Amps, Simpson 35, 3 1/2" Round flush bakelite @ \$5.50
- 2.5 Amps, Westinghouse NT-35, 3 1/2" Round flush bakelite Signal Corps IS-111... @ \$8.00
- 2.5 Amps, McClintock MD 3001, 3 1/2" Round flush bakelite, Signal Corps Stock IS-111... @ \$4.50
- 2.5 Amps, Weston 425, 3 1/2" Round flush bakelite @ \$8.50
- 3 Amps, Weston 507, 2 1/2" Round flush bakelite, black scale @ \$4.50
- 3 Amps, Weston 425, 3 1/2" Round flush bakelite, with external thermocouple @ \$9.50
- 3 Amps, Westinghouse NT-35, 3 1/2" Round flush bakelite (JAN type MR35W093RFAA3) @ \$6.00
- 5 Amps, G.E. DO-44, 3 1/2" Round fl. bakelite @ \$7.50
- 5 Amps, General Electric DO-44, 3 1/2" Round bakelite with external thermocouple @ \$8.50
- 6 Amps, General Electric DW-44, 2 1/2" Round flush bakelite, black scale @ \$3.50
- 8 Amps, West. RT-35, 3" Square fl. bakelite @ \$7.50
- 8 Amps, Weston 425, 3" Square flush bakelite case @ \$10.50
- 10 Amps, Weston 425, 3 1/2" Round flush bakelite @ \$8.50
- 10 Amps, Weston 425, 3 1/2" Round flush bakelite MR35W010RFAA @ \$9.50
- 1 Amp, Westinghouse NX-35, 3 1/2" Round flush bakelite case (JAN type MR35W010DCAA) @ \$6.00
- 1 Amp, General Electric DO-41, 3 1/2" Round flush bakelite CG-22000 @ \$5.50
- 2 Amps, General Electric DO-40, 3" Round flush ring-mounted non-flanged bakelite case @ \$4.95
- 5 Amps, General Electric DO-40, 3" Round, non-flanged, ring-mounted fl. bakelite case @ \$4.95
- 10 Amps, General Electric DO-40, 3" Round, non-flanged, ring-mounted fl. bakelite case @ \$4.95
- 15 Amps, Triplett 0321-T, 3 1/2" Round flush bakelite case @ \$4.50
- 30 Amps, General Electric DW-51, 2 1/2" Round flush bakelite case (JAN type MR24W050DCAA) @ \$4.50
- 30-30-30 Amps, Beede, 2 1/2" Round flush bakelite case @ \$3.00
- 30-0-30 Amps, General Electric DW-51, 2 1/2" Round flush metal @ \$3.50
- 50-0-50 Amps, General Electric DO-41, 3 1/2" Round flush bakelite, black scale with luminous markings @ \$5.50
- 100 Amps, Westinghouse OX-33, 2 1/2" Round flush bakelite case 50 M.V. movement, with leads but without shunt @ \$2.95
- 150 Amps, Simpson 125, 2 1/2" Round flush metal case, complete external 50 M.V. shunt... @ \$5.50
- 200 Amps, Weston 506, 2 1/2" Round flush bakelite case, 50 M.V. movement with external shunt. (JAN type MR24W200DCAA) @ \$7.50
- 200 Amps, General Electric DO-41, 3 1/2" Round flush bakelite, complete with external 50 M.V. shunt @ \$9.50
- 200-0-200 Amps, Weston 506, 2 1/2" Round flush bakelite case, complete with external 50 M.V. shunt @ \$7.50
- 300 Amps, General Electric DW-51, 2 1/2" Round flush bakelite 50 M.V. movement, requires external shunt (JAN type MR24W300DCAA) @ \$4.50
- 500 Amps, General Electric DW-51, 2 1/2" Round flush bakelite case, 50 M.V. movement, without shunt @ \$3.95
- 600 Amps, General Electric DO-47, special 3 color scale without calibration, 50 M.V. movement, 3 1/2" Round flush metal case @ \$4.00

## D. C. MICROAMMETERS

- 500 Microamps, General Electric DO-53, 3" Square flush bakelite scale calib. 0-15 Kilovolts D.C. @ \$5.95
- 500 Microamps, General Electric DW-40, 2" Round flush ring-clamp mounted (non-flanged) bakelite case, 100 M.V. sc. calib. 0-1 Milliampere, approx. 200 ohms resistance... @ \$3.50
- 500 Microamps, General Electric DO-41, 2 1/2" Round flush bakelite sc. calib. 0-20 Kilovolts D.C. approx. 250 ohms resistance... @ \$5.95

## D. C. MILLIAMMETERS

- 1 MA, General Electric DW-41, 2 1/2" Round flush bakelite case, special sc. calib. 140 volts and 600 MA @ \$3.95
- 1 MA, Westinghouse NX-33, 2 1/2" Round flush bakelite case, black scale calib. 140 volts, 500 MA @ \$3.95
- 1 MA, Westinghouse NX-35, 3 1/2" Round flush bakelite (JAN type MR35W012DCMA), approx. 55.7 ohms resistance @ \$7.50
- 2 Milliams, Westinghouse NX-35, 3 1/2" Round flush bakelite case (JAN type MR35W02DCMA) @ \$5.50
- 3 Milliamps, Gruen GW-587, 2 1/2" Round flush bakelite case, scale calib. 30 and 450 MA and 8000 volts @ \$3.50
- 3 Milliamps, Simpson 126, 2 1/2" Round flush bakelite case, (JAN type MR25W00DCMA) @ \$4.50
- 15 Milliamps, Simpson 26, 3 1/2" Round flush bakelite case, (JAN type MR25W015DCMA) @ \$6.00
- 20 Milliamps, General Electric DO-53, 3" Square flush bakelite @ \$5.50
- 50 Milliamps, General Electric DO-41, 4 1/2" Round flush bakelite @ \$4.95
- 150 Milliamps, Electrical #350, 3 1/2" Round flush bakelite case, made by Elec. Division of US Time Corp. @ \$4.00
- 150 Milliamps, Weston 506, 2 1/2" Round flush bakelite case @ \$4.50
- 150 Milliamps, General Electric DO-53, 3" Square flush bakelite @ \$5.50
- 150 Milliamps, Triplett, 2" Square flush bakelite, black sc. @ \$3.95
- 150 Milliamps, Gruen 506, 2 1/2" Round flush bakelite case @ \$3.95
- 200 Milliamps, Marton, 3 1/2" Round flush bakelite case, knife edge pointer @ \$4.00
- 200 Milliamps, General Electric DO-41, 3 1/2" Round flush bakelite @ \$5.50
- 200 Milliamps, Simpson 26, 3 1/2" Round flush bakelite (JAN type MR35W200 DCMA) @ \$5.95
- 300 Milliamps, General Electric DO-53, 3" Square flush bakelite @ \$4.50
- 500 Milliamps, General Electric DW-41, 2 1/2" Round flush bakelite case, black scale (Signal Corps Stock # IS-22) @ \$3.95
- 500 Milliamps, General Electric DO-53, 3" Square flush bakelite @ \$5.50
- 500 Milliamps, General Electric DW-51, 2 1/2" Round flush bakelite @ \$4.50
- 500 Milliamps, Dejur Amco 312, 3" Square flush bakelite @ \$5.00
- 800 Milliamps, Dejur Amco # 310, 3" Round flush bakelite case Signal Corp Stock # 3F980 @ \$4.50
- 800 Milliamps, Weston 301, 3 1/2" Round flush bakelite @ \$5.95
- 800 Milliamps, General Electric DO-41, 3 1/2" Round fl. bakelite @ \$4.95
- 1000 Milliamps, Weston 301, 3" Square flush bakelite case @ \$6.50
- 1000 Milliamps, Western Electric type D-55049, 3 1/2" Round fl. bakelite, concentric style movement, with 190° scale length @ \$4.00
- 1000 Milliamps, Electel 350, 3 1/2" Round flush bakelite case, (JAN type MR35W100DCMA) sc. calib. 0-100, caption "DC Milliampere x 10" Mfg. by Electrical Division of U.S. Time Corp @ \$4.50

## D. C. VOLTMETERS

- 5/125 Volts, Dual Range, Weston 506, 2" Round flush metal, ring clamp mounted (non-flanged) approx. 135 ohms per volt, plus button for high range @ \$4.00
- 20 Volts, McClintock MD2001, 2 1/2" Round flush bakelite case, 1000 ohms per volt MR25W020 @ \$4.50
- 30 Volts, General Electric DO-41, 3 1/2" Round flush bakelite case, 100 ohms per volt @ \$6.00
- 30 Volts, General Electric DO-40, 3" Round non-flanged, ring mounted flush bakelite case, 100 ohms per volt @ \$4.95
- 35 Volts, Simpson 125, 2 1/2" Round flush metal case, approx. 110 ohms per volt, made for Homelite Corp. @ \$4.00
- 40 Volts, Sun 3AP593, 3 1/2" Round flush bakelite case, 100 ohms per Volt, made for Mallory @ \$5.95
- 75 Volts, General Electric DO-40, 3" Round non-flanged ring mounted flush bakelite case, 100 ohms per V @ \$4.95
- 150 Volts, Roller Smith type FDS, 3 3/4" x 3 7/8" surface mounted bakelite case, 100 ohms per volt @ \$12.00
- 300 Volts, Sun 2AP380, 2 1/2" Round flush bakelite case, 1000 ohms per volt (JAN type MR25W000DCV) @ \$6.00
- 500/500 Volts, Weston 506, 2 1/2" Round flush bakelite case, Dual range 1000 ohms per volt, black scale with luminous markings @ \$5.50
- 750 Volts, Westinghouse RX-35, 3" Square flush bakelite case, 1 MA movement, complete with external resistor @ \$8.05

## D. C. KILOVOLTMETERS

- 2 Kilovolts, General Electric DO-53, 3" Square flush bakelite, 1 MA movement complete with 1000 ohms per volt precision ferrule-type multiplier @ \$10.95
- 4 Kilovolts, Dejur Amco # 310, 3 1/2" Round flush bakelite case, 1 MA movement @ \$4.50
- 15 Kilovolts, General Electric DO-41, 3 1/2" Round flush bakelite case, 1 MA movement (JAN MR34W015DCKV) @ \$6.50
- 20 Kilovolts, General Electric DO-41, 3 1/2" Round flush bakelite, 1 MA with multiplier @ \$27.95

## A. C. AMMETERS

- 150 Milliamps, General Electric AO-22, 3 1/2" Round flush bakelite @ \$4.95

- 30 Amps, Triplett 332-JP, 3 1/2" Round flush metal case @ \$4.00
- 50 Amps, Westinghouse NA-35, 3 1/2" Round flush bakelite 500 cycles @ \$5.50
- 60/120 Amps, Dual Range Burlington 32 x C, 3 1/2" Round flush bakelite, 5 amp. movement with external current transformer @ \$7.50
- 75 Amps, Burlington 32 C, 3 1/2" Round flush bakelite @ \$4.95
- 150 Amps, Multirange, Westinghouse NA-35, 3 1/2" Round flush bakelite with Current Transformer @ \$7.95

## D. C. AMMETERS SPECIAL METERS

- Suppressed Zero Micrometer, Hickok 56 C, 2 1/2" Round flush bakelite case, Suppressed zero type, 600 Microampere D.C. Approx. 150 ohms per amp. Scale, approx. 1000 ohms resistance, Special "Battery Volts" scale @ \$3.50
- Rectifier Milliammeter, McClintock, 2" Round flush metal non-flanged ring mounted case, 1 MAAC, 700 uads with 1/2 wave rectifier black scale, calib. 0-10, Signal Corps Stock 3F891-2 S. In. inspection @ \$3.50
- Rectifier Milliammeter, Weston 545 type 81, 270° concentric style P.S. 1 MAAC, 940 uads 70 ohms, with rectifier, black scale calib. 0-270... @ \$6.50
- S Meter, Simpson 25, 3 1/2" Round flush bakelite case, 5 MA zero right movement, Caption D B Above 1 Microvolt with translucent scale & internal illuminating feature @ \$4.50
- Frequency Meter 350-450 cycles, Weston 637, 4" Square, 4 hole mtg., 115 Volt, Electrodynamic meter type @ \$7.50
- Decibel Meter, High Speed type Multirange, Weston 301 type 61, 10 to 120 dB, 6 Mw in 600 ohms; ODB equals 1.9 volt 5000 ohms resistance, High speed type 29 to 35 seconds to find reading, Only 2-6% overthrow, 18-50 Damping factor, Complete with 3 external wires wound, resistors @ \$11.50
- Weston 545, type 81, Rectifier type milliammeter, 270° movement 4" Aircraft type case, full scale 1 MAAC @ \$6.50
- Zero Center D.C. Milliammeter I-0-1 DCMA MV Weston Model 502, 6" Square flush metal, black scale calib. 900-0-900 RPM @ \$18.00

## AIRCRAFT METERS

- 5-0-.5 D.C. MA, General Electric DW-53, 10 sc. div. no numbering, Caption Bottomside with illum. feature 2 1/2" Square flush type, 4 hole mtg. with luminous markings and luminous markings @ \$3.50
- 30 Volts 30 Amps D.C. Dual Meter, Weston 606, complete with external 50 M.V. shunt, normally indicates amps, with push button for volts, 2 1/2" Square flush type, 4 hole mtg. with black scale & luminous markings @ \$6.00
- 30 Volts 60 Amps D.C. Dual Meter, General Electric, AN connector type, complete with external 50 M.V. shunt & connector, normally indicates amps, with push button for volts, 2 1/2" Square flush type, 4 hole mtg. with luminous markings @ \$5.50
- 30 Volts 240 Amps D.C. Westinghouse AX-33, Complete with external 50 M.V. shunt, normally indicates amps, with push button for volts, 2 1/2" Square flush type 4 hole mtg. with black scale & luminous markings @ \$7.50
- 0-30 Volts, Westinghouse AX-33, 2 1/2" Square, case, black sc. @ \$4.50
- 0-30 Volts D.C. Weston 606, 2 1/2" Square flush type, 4 hole mtg. with black sc. & luminous markings @ \$4.50
- 0-30 Volts D.C. General Electric DW-53, 2 1/2" Square flush type, 4 hole mtg., black scale @ \$4.50
- 0-30 Amps D.C. Westinghouse AX-33, USN-C30 in. shunt, 2 1/2" Square flush type, 4 hole mtg. with black scale and luminous markings... @ \$5.00
- 30-0-30 Amps D.C. Weston 606, with internal shunt, 2 1/2" Square flush type, 4 hole mtg. with black scale and luminous markings @ \$5.00
- 60 Amps D.C. Westinghouse AX-33, 2 1/2" Square flush type, 4 hole mounting @ \$5.50
- 60 Amps, D.C. General Electric, complete with external 50 M.V. shunt, 2 1/2" Square flush type, 4 hole mtg. with black scale and luminous markings @ \$5.00
- 60-0-60 Amps D.C. Weston 606, complete with external 50 M.V. shunt, 2 1/2" Square flush type, 4 hole mtg. with black scale and luminous markings @ \$5.50
- 20-0-100 Amp D.C. Hickok, 2 1/2" Round flush metal case, black scale, requires external shunt @ \$4.50
- 20-0-100 Amps D.C. Weston 506, 2 1/2" Round flush metal case, complete with external 50 M.V. shunt, black scale @ \$6.50
- 120 Amps D.C. Westinghouse AX-33, complete with external 50 M.V. shunt, 2 1/2" Square flush type, 4 hole mtg. with black scale & luminous markings @ \$5.50
- 120-0-120 Amps D.C. Westinghouse AX-33, complete with external 50 M.V. shunt, 2 1/2" Square flush type, 4 hole mtg. with black scale & luminous markings @ \$5.50
- 150 Amps D.C. Westinghouse F-1 (NX-33) 2 1/2" Round flush metal case, black scale luminous markings, 50 M.V. movement with external shunt... @ \$6.50
- 240 Amps D.C. Sutton-Horsley Br. Complete with external 50 M.V. shunt, 2 1/2" Square flush type, 4 hole mtg. with black scale and luminous markings @ \$5.50
- 240 Amps D.C. Westinghouse AX-33, complete with external 50 M.V. shunt, 2 1/2" Square flush type with black scale and luminous markings... @ \$6.50
- 240-0-240 Amps D.C. General Electric DW-53, complete with external 50 M.V. shunt, 2 1/2" Square flush type, 4 hole mtg. with black scale & luminous markings @ \$6.50

**MARITIME SWITCHBOARD INSTRUMENTS—ACCESSORIES**  
 338 Canal St., N. Y. 13, N. Y.  
 Worth 4-8217

Orders accepted from rated concerns, public institutions and agencies on open account, others please send 25% deposit, balance C.O.D. or check with order. All prices FOB our warehouse, N.Y.C.



RELAYS

Description	Ohms Mfr.	Cat. No.	Price
2 amp. contacts 24 VDC DPST (NO) SPDT	700 WE	D170067	\$1.10
24 VDC 3A Cont. contacts DPDT Ceramic SPDT 2 amp. Cont.	100 GE	CR2791-D101F3	1.10
24 VDC SPST (NO) 24 VDC 6 amp. Cont.	Allied	452-1127-2	.95
DPST (NO) 6A Cont. 6 VDC	33	5.E.2	1.10
DPDT 28 VDC 3A Cont.	350 Allied	BJ P-8-4	.95
SPDT 28 VDC 2A Cont.	300 Allied	452-1298	.95
DPST (NO) 2A Cont. 24 VDC	350 Allied	TS1-C	.95
DPDT 24 VDC 5A Cont.	200 Allied	BA-11755-8	1.15
DPST (NO) 2A Cont. 24 VDC	260 Allied	BO 6D35	.95
DPST (NO) 2A Cont. 12 VDC	400 Allied	P-9-4	.95
TPDT 26 VDC 10A Cont.	200 Allied	KC029260	1.15
SPDT DOUBLE BRK. 12A Cont. 28 VDC	200 Allied	K55910-L11 Box-48	1.15
SPDT 3A Cont. Less Cover	FTR	AD 1565	1.45
DPST (NO) 4A Cont.	490	GR206	.95
SPST 24 VDC For 1S16/APN 5A Cont.	526 Allied	452-1084	
DPST (NO) SPDT 3A Cont. 3A Cont.	5800 WE	227586-24	1.10
DPST (NO) SPDT 3A Cont. 3A Cont.	1300 WE	K 301	.95
DPST (NO) SPDT 3A Cont. DPDT 2A Cont.	700 WE	D169615	.95
DPDT 12V 10A Cont. 5A Cont.	150 GE	D169316	.95
DPDT 24V Ceramic 10A Cont.	44 Leach	D170087	.95
DPDT 2A Cont.	425 Leach	D170087	.95
DPDT 2A Cont.	160 Leach	CR2791B100	.79
4PST (NO) 24V 10A Cont.	150 GE	I3	
SPDT 3A Cont.	150 GE	1007-490	1.29
TPDT 2A Cont.	150 GE	1025-SNBF	1.29
SPDT 3A Cont.	150 GE	1077-BF	1.29
DPDT 2A Cont.	150 GE	K35J367-2	.79
SPDT 3A Cont.	150 GE	CR 2791-B100F3	.99
TPDT 2A Cont.	150 GE	CR2791-G100K4	.99
DPST (NO)	150 GE	CR2791-B100F3	.79
TPDT 2A Cont.	150 GE	CR2791-B100J3	.95
DPST (NO)	150 GE	CP Claire	1.50
TPDT 2 amp. Cont.	4850 WE	D171258	1.20
DPDT (DPST) 2A Cont.	112 WE	For ARC3	.70
SPDT. BRK MAKE 2A Cont.	300 Allied	55530	.50
DPDT 12V 3A Cont.	112 WE	73B87	1.20
SPST AIRCRAFT 24V 100 amp. Cont.	Leach	BU Type	
DPDT 24V 3A Cont.	Allied	B030309	
SPDT (SPST) (NO)	100	5058	
Dual SPST (SPST) (NO) 24V 10A Cont.	100 Aircraft	7058-24	
Timing SPST 20-29V 25A Cont. Relay	100	5519-103	.95
SPDT, SPDT (NO) 115V 60 Cy. 2A Cont.	100	For Ant. RC442	
DPST (NO) 14V 15A Cont.	1000 Auto	274N-ARC 7735	
DPST (NO) 70 VDC 25A Cont.	1000 Auto	5023-C-G17	
DPDT 2A Cont.	1000 GE	P75	1.45
DPST (NO) 6V 10A Cont.	30 Radionic	For AN/TPS-1B	3.49
24V Hlamp Cont.	6500 Auto Elect.	CR2791-J105A53	1.95
SPDT, SPST (NO) 21.5V 2 amp. Cont.	6000	RP649B	
SPST (NO) 2A Cont.	6000	A6941 227588-80	
DPDT 2A Cont.	100 GE	For BC 303B	
DPST (NO) 6V 10A Cont.	30 Radionic	A3-20-1	1.49
24V Hlamp Cont.	6500 Auto Elect.	For H77318-2	1.50
SPDT, SPST (NO) 21.5V 2 amp. Cont.	6000	For BD62-B	
SPST (NO) 2A Cont.	6000	Pot Brum	
DPDT 2A Cont.	100 GE	A 3098	.95
DPDT 24V 10A Cont.	200 Allied	For GN 45	1.95
DPDT 10A Cont.	200 Allied	C 189	
Dual Coil	GM	Cotter Hammer 6041 H24A	
4PST (NO) 24V 10A Cont.	100 GE	Auto Elect. For T19B/	.95
SPST (NO) (DB 1 Brk)	42 Leach	H70984-3	.95
SPST (NO) 24V 10A Cont.	50 Allied	H77312	
DPDT 28V 2A Cont.	400	CR2791	1.29
Dual w/arm	400	D100F3	
w/arm	400	BO635	1.15
SPST (NO) 5A Cont.	200 GM	71-5015	1.20
Dual Coil	200 GM	13038	
SPST 2 amp. Cont. Plug in	.016 Kohler	CR2791-G100K4	1.75
SPST (NO) 10Amp. Cont.	.016 Kohler	G100K4	1.59
SPST AIRCRAFT 24V High amp. Contact	CH	1224-322	
AIRCRAFT 24V 100 amp. Contact	SQD	P-8-4	
DPDT 2 amp. Cont.	250	H704482	.95
DPDT 24V 3 amp. Cont.	200 Allied	H70255-4	.95
DPST (NO) 6 VDC 6 amp. Cont.	33 Gentelev	12917-1	1.20
3PST (NO) SPST (NO) 2 amp. & 4A Cont.	490	K52J521	.95
DPDT 9-14V 5 amp.	Allied	2444A6	.95
SPST (NO) DOUBLE BRK DUAL RELAY 24V 10amp. Cont.	160 Leach	RE5607	
DPDT 3 amp. Cont.	Allied	For PE75-T	1.50
DPST (NO) 6V 6 amp. Cont.	33 Burke	7110-2	
DPST (NO) 48V 3 amp. Cont.	1300	32324	

JUNCTION BOXES

Pilots control box for RL7 inter-phone equip. \$1.29  
 Junction box J23/ARC3

Tuning control BC496A for ARC5 \$1.00  
 Push button control C-30/ARC/5 \$1.95  
 Junction box J-17A/ARC5 \$2.49

Junction box TM-AA 160 75c

Interphone box BC 606 G for SCR 538 \$1.00  
 Junction box J-22B/ARC5 \$1.25  
 Loading coil TN-6/ARC5 \$2.29

VITREOUS RESISTOR & OTHERS

Ohms	Size	Type	Price
5M	2x3/4"	Lugs	20c
12	2x1/2"	Lugs	18c
2500	2x3/4"	Lugs Var.	20c
5M	2x3/4"	Lugs	20c
100	1 1/2 x 3/4"	Lugs	15c
3150	2x3/4"	Lugs	20c
1000	2x1/2"	Leads	20c
500	4 1/2 x 7/8"	Lugs	30c
7500	4x3/4"	Lugs	30c
10	2 1/2 x 3/8"	Lugs	35c
3000	3x3/4"	Lugs	25c
12000	3x3/4"	Lugs	25c
10	6 1/2 x 1 1/2"	Lugs	45c
5CT	6 1/2 x 3/4"	Lugs	40c
5000	2x3/4"	Lugs	20c

PORTABLE CASES

Reg. Size Record Player Case. CASE: 3/8" Plywood Construction 10 7/8" x 7 1/2". Cut out for Speaker Box 13 1/2" x 15" x 2 3/4". Opens on Top. W/2 2 Hasp Locks on Side & Carrying Handle.

Dimensions: 20 1/2" x 15" x 8 3/4".

Hardware: Wine or Blue Thin Leatherette.

Hardware: Large Non Rattle Carrying Handle, w/4 Metal Dome Feet. New. PRICE \$2.75

Reg. Traveling Radio Case. Case: 3/8" Plywood Construction. w/shelves inside backpan. Less Front panel 5 5/8" x 11 3/4". Dimensions: 10 1/2" x 13 3/4" x 6 1/4". Covering: Brown, Blue or Red Leatherette Covering.

Hardware: Large Non Rattling carrying handle w/4 Metal dome Feet. Hardware: Large Bakelite Handle w/4 Metal Dome Feet. PRICE \$2.50

HEADSETS & MIKES

HS23 Used Good 8000 Imp. \$2.49

HS33 Used Good 600 Imp. \$2.49

HS30B Replace Elements 60c ea.

Rubber Earplugs for HS30 \$1.00

Matching XFRMR C 110 Less Cords .59c

T45 Lip Mikes .99c

T30 Throat Mike .39c

CS508T30 Ext. Cords w/ Switch Sw141 Complete \$1.25

Gas Mask Mike Elements .49c

Cords 3 Cond. Color coded approx. 42' @ .5c ea.

Hi-band HBI .25c

Hi-band HB30 .25c

BC 605 INTERPHONE AMPLIFIER

Easily converted to an ideal intercom unit. Home set for office-home or factory. Complete w/conversion diagram for 110 V operation. Brand New. \$4.49 Used \$3.95

Aircraft Rec. #429 for Mobile or Aircraft Covers from 201 Kc interchange plug in timing units includes one Tuning Unit. Less Tubes. Rec. Only a few left. \$3.95 ea.

Heineman Ckt Bkrs for AC-DC operation.

AM 1510M 7 Amp  
 1614 80 Amp  
 1614 50 Amp  
 U90 100 Amp

Price ea. \$1.10  
 P-0322 Dual 10 Amp.  
 Price ea. \$2.25



400 MA 12 HY Choke 90 ohms Herm. sealed Special \$3.75

CHOKE SWINGING

9/60Hv. 400/.05 Amp. 10000V ins. Mfg. Super. Elect. \$7.95

872 FIL XFRMR Pri: 115-125V 60cy Sec: 2x2.5/20A 66.95

CHIME XFRMR Pri: 110V 60 cy Sec: 24V/1A \$1.25

POWER XFRMR Pri: 110V 60 cy Sec: 4V/16A 2.5V/1.75A Ideal for 2x2 & 826 Tubes \$1.95

HF-185 — 120 watt Modulation Trans-former — as used in the Army BC-191 and RC-375 Xmters. Designed for class B modulating a single 211 with push-pull 211's 4000 ohm plate to plate load impedance into a 7000 ohm load. With this transformer and 211's you can build yourself a good economic modulator for an 804, 814 or similar final. \$1.49 each

PRECISION RESISTORS

.6	7500
1.01	8500
5	10,000
5.05	10,000
10.1	10,000
125	30,000
128	33,000
150	40,000
128	55,000
250	57,000
300	75,000
430	84,000
468	100,000
800	120,000
920	120,000
1100	150,000
4300	220K
5000	250K

@ 30c ea.  
 10 for \$2.50  
 @ 40c ea.  
 10 for \$3.50  
 1 Meg. @ 75c ea.  
 10 Meg. @ \$2.10 ea.

ELECTROLYTICS Prong Mount D. Y. Type A.C. Cond.

13-15	220-1.20
20-24	110-1.00
26-30	220-1.35
43-65	110-1.25
110-125	110-1.25
50-75	110-1.25
53-60	220-1.50
61-69	320-1.60
64-72	110-1.25
72-87	110-1.25
75-84	110-1.25
88-106	110-1.50
107-129	110-1.65
130-157	110-1.75
130-150	70-1.50
130-180	110-1.85
158-191	110-1.85
161-180	110-1.75
189-210	110-1.95

AUDIO TRANSFORMER

ITEM AT666	Input 6 ohms: 250K ohms	79
AT SUB	Multimatch Subouncer 200 ohms 15K ohms C.T.: 100K ohms 20K ohms	69
AT070	Input to Grid 250 ohms: 60K ohms H1 P1	1.19
AT566	Input to Grid, 500/200 ohms 50K ohms	.95
AT227	Output to line, 7500K 500 ohm CT 200-5ky	1.45
AT353	Output EP 6L6 to 300/20/12 16 ohms 25 Watt	2.95
AT871	UNIV. Output, H1 P1. Pri 20K ohms nec. 15/7.5/5/3.75/1.25 500 ohms	2.79
AT554	Interstage, 10K ohms: 250K ohms 15B Level	1.95
AT765	Input 600 ohms to 50K ohms	.79
AT707	Interstage uncoupled 10K ohms: 125/125K ohms	.79
AT750	Input Pri: 15/15 ohm Sec: 180K ohm	.59
AT449	Driver 5k ohm to 4K ohm PP6L6 to PP505 Class B	3.89
AT21	Dual XFRMR 800 ohms: 360 ohms and 600 ohms: 250K ohms	1.35
AT383	Output 8500 ohms: 19 ohms 25V	1.79
AT415	Output 18K ohms CT to line 125 ohms 175W	2.95
AT649	Input. Line 500 ohms T Grid, 75K ohms	.79

MANY OTHERS



DYNA-MOTORS AT SURPLUS PRICES



Type	Input Volts	Output Amps.	Radio Set
PE88	13/26	12.6	2/3 SCR 515
DM416	14	6.2	330 .070 RC 36
DY-2/ARR-2	28	1.1	250 .060 RU 19
DM36	28	1.4	220 .080 ARC-5
DM25	12	2.3	250 .050 BC 367
	28	1.25	275 .070 BC 348
DM31A	28	7	540 .250 BC 456
DM42	14	46	515 .110 SCR 506

PE10C	13/26	12.6	400 .135 2/8 SCR 515
		6.3	800 .020
BD AR 93	28	3.25	375 .150
23350	27	1.75	285 .075 APN-1
35CO458	28	1.2	250 .060
ZA-085	12/24	4/2	500 .050
ZA-056	12/24	8/4	12/275 3/110
B-19pack	12	9.4	275 .110 Mark II
			500 .050
			9 1.12
D-104	12	225	100
		440	200
DA-3A	28	10	300 .060 SCR 522
			150 .010
			14.5 .5

5053	28	1.4	250 .060 APN-1
PE73CM	28	19	1000 .350 BC 375
DM21	14	3.3	235 .090 BC 312
CW21AAX	13	12.6	400 .135
	26	6.3	800 .020
			9 1.12
BD 77KM	14	40	1000 .350 MC191
PE94	28	10	300 .200 SCR
			150 .010 522
			14.5 .5

PRECISION RESISTORS

D-164886A	2.65 ohms
D-164886AA	3.83 ohms
D-167026	13,500/10,500 ohms
D-162025AT	1400/135/270 ohms
D-164285	40,600/1500 ohms
D-16680PL	115 ohms
D-16270CY	2500 ohms
D-171862	279 ohms
D-171863	591 ohms
D-164286	10,000/15,000/62,000 ohms
D-164284	100,000/50,000 ohms
D-172241	400,600/700/750 ohms

@ \$1.00 ea.

AN CONNECTORS



AT GREAT SAVINGS LARGE VARIETY AVAILABLE

Voltage Stabilizer VTR3 95-130V 2.4A 60  
 Voltage Regulator VII CT 13 out 115V 120W 623 95-130V 1.75A  
 100% Raytheon w/ 800V 1d CU 115V  
 Ext. RX Box. Sock- 150W 100%. Slightly  
 ets. Cable. Used but used. Excellent.  
 good.  
 Price \$18.95

All merch. guar. Mail orders promptly filled. All prices F.O.B. N. Y. C. Send MO or Chk. Only shipping chgs. sent C.O.D. Rated concerns send P.O.

MIN. ORDER \$3.00





Complete stock of Relays available for immediate shipment. All sold at surplus prices. Write for Latest Relay List. Now Available.



CAPACITORS



BATHTUBS

Table with columns: Mfd., Volt, Type, Cat. No., Price. Lists various bathtub components and their prices.

UPRIGHTS

Table with columns: Mfd., Volt, Type, Cat. No., Price. Lists various upright components and their prices.

BC-733D SUPERHET RECEIVER

FT-241. A holder 1/2" pin spacing. For ham and general use. Kital controlled Signal Generators, marked in army Mc harmonic frequencies—Directions for deriving fundamental frequencies enclosed. Listed below by fundamental frequency, fractions omitted.

Table with columns: Frequency, Price. Lists various frequencies and their prices.

CRYSTALS Low Freq.

Table with columns: Frequency, Price. Lists various crystal frequencies and their prices.

RL9 or RL7

Interphone Amplifier Converter to High Fidelity Phone Amp. or Spch. Amp. Comp w/ 2 Choke 2 I.X. RFRMR. DYN. for 2d operation, etc.

Table with columns: Price. Lists various prices for RL9 or RL7 components.



EE89A Telephone Repeater

Used to extend range of field telephone. Simple to install. Teleg. and 20 cycle ringing possible over lines supplied with 110 unit. Supplied w/ 305 tube. Phone supplied (featherweight) \$9.59

COLLINS ART. 13 FREQ. MULT. UNIT

2-18 Mc for two 1625 Tubes. Comp. Assy less Tubes & Coils w/ 1000000. Price \$8.95

MOUNTINGS

Table with columns: Part No., Price. Lists various mounting parts and their prices.

SHOCK MOUNTS

Table with columns: Part No., Price. Lists various shock mounts and their prices.

Model 542 Supreme Sensitivity. 5,000 Ohms/3 square meter. Reads: D.C. volts, 6-150-300-1,500; A.C. volts, 6-30-150-600; D.C. ma., 0.3-6-30-150; 2,000-20,000-200,000, 2 megs; db., -8 to +50; Output, 6-30-150-600 volts. Bakelite case, 5-7/8 x 3 1/16 x 2-1/8" Shpg. wt. \$8.95 ea. Model 442 Rad-City. Same as above. \$8.95 ea. Model 666-SC 561 Triplet VMC. 3/16 x 9/16 x 9/16. Price \$7.95 ea. Model Same as Chicago. Price \$7.95 ea. All above meters are sold as is. No refund minor repairs required.

0-30V DC Meter Westing. Type AX Aircraft type Price \$2.49

Weston 3 1/2" Rnd. Bake 0-500 Ma. RF Thermocouple Model 425 Res.-1.5 Ohms. Chicago. 15-110 Double range 0.3 & 0-75 V Internal Res. \$4.75 Triplet Model 221 2 1/2" rnd. 0-500 Ma. \$3.95 2 1/2" rnd. Bake G. E. Model ADF-10 type DW 51 0-500 Ma. \$3.95 McClincock 3 1/2" Rnd. Tuning Ind. for S-37 FM Tune, etc. DB over 50. \$5.95 2 1/2" rnd. 0-5 Air Weston 507. \$3.95 3 1/2" rnd. Bake 0-10 V Marked 0-100 and 0-250 Ma. General Electric model VY 412 \$4.95 IN1909 3 1/2" rnd. Bake. 0-5AAC basic. Marked 0-120 A. A. C. Western Electric type NA 35 \$6.49

FUSES

Table with columns: Amp., Volt, Type, Size, Price. Lists various fuses and their prices.

0-1MA 3 1/2" Rd. DeJure Mod S-310

Price ea. \$4.75 0-1MA 3 1/2" Rd. Same as above. Mfg. Sun Mfg. Mod 3AP259. Price ea. \$3.95 0-10MA 3 1/2" Rd. DeJure Mod S-310. Price ea. \$5.95 0-10MA 3 1/2" Rd. Same as above. Mfg. Sun Mfg. Mod 3AP236. Price ea. \$3.95

Multimeter Mvmt.

0-100 Mcv. 0-800/1500 50/14VDC (0-5 Ma Basic) 3" Rd. Metal Stm to Simpson #23 \$3.95

METERS

0.5Ma Sq 2" Metal Case 0-10 volt movement readrite meter \$98c

0-100 Mcv. 0-800/1500

50/14VDC (0-5 Ma Basic) 3" Rd. Metal Stm to Simpson #23 \$3.95

Multimeter Mvmt.

0-100 Mcv. 0-800/1500 50/14VDC (0-5 Ma Basic) 3" Rd. Metal Stm to Simpson #23 \$3.95

METERS

0.5Ma Sq 2" Metal Case 0-10 volt movement readrite meter \$98c

SELSYN TESTER

Magnesium Instrument Field Tester AAF 43G2333. Special 40772 To test individual mag. Ind. & Xmitters, for isolating faults in magnesium systems. Brand new \$99.00

T. U. for BCAR230 or 430

3.2-4MC 150-200 5-6.2MC 150-200 1.2-1.5MC 150-200 1-1.2MC 150-200 Price 95c ea. 4-SMC w/ 4495KC 150-200 XTAL \$1.69

ARC 5 MODULATOR

MDT/ARC5 w/ dynamotor complete w/ Tubes 1-1215, 2-1625, 1-UR50. Good cond. Price \$8.95

MS-19 and MS50

Fish Pole Antenna Screen Mod. XFRMR for pair of 807's PP - PP or Parll Sidetone Wndg. \$95c

SCR274

Are you getting a good V. Picture. Here is a big Corp. Ant. mast 30" high of rugged plywood construction to solve your problem. It telescopes into 3 ten ft. sec. for easy storage. Easy to Mt. Comp. with stakes & rods. Ea. \$19.95.

VFO Capacitor

High grade unit consists of 420 MMR per sect. ceramic ins. low drift; w/worm reduction gear 120:1 w/ext. shaft and 4 digit Vocoder counter \$3.95

GIBSON GIRL

The Emergency Radio Transmitter, sends SOS signals automatically on 500KC. 150-watt rampanc. No batteries required. Has generator, tubes, wire. New. It's only \$4.25 each

PHOTO PRINT-DRIVERS

Consists of microem element installed from open frame 9 3/4" x 10" 110V 60 cy. \$75c

CONDENSER TUNING UNITS FOR BC 191 or 375

Write up in OCT QST for Copy to vhf meter TU 5-1500 to 3000 KC TU 6-3000 to 4500 KC TU 7-4500 to 6200 KC TU 8-6200 to 7700 KC TU 9-7700 to 10000 KC TU 20-200 to 500 KC Price \$2.49 ea.

TUNING UNITS FOR BC 223 XMITTER

TU17A 2000-3000Kc. \$2.75 TU18 3500-4500Kc. 2.25 TU25 3500-5200Kc. 2.25

ANTENNA MAST

Are you getting a good V. Picture. Here is a big Corp. Ant. mast 30" high of rugged plywood construction to solve your problem. It telescopes into 3 ten ft. sec. for easy storage. Easy to Mt. Comp. with stakes & rods. Ea. \$19.95.

AMPLIFIER

AM-32/PRII less batt w/carry case for Mine Detector AN/PRII. Price ea. \$7.95

Oil Condensers Famous Makes Brand New

Table with columns: Mfd., Volt, Price. Lists various oil condenser models and their prices.

ARC/5 BATHTUBS

Table with columns: Mfd., Volt, Price. Lists various ARC/5 bathtub models and their prices.

Universal Transformer

Amertran Silcor. PRI-20,000/16,000/5,000/4,000 ohms. Sect. 500/15/7.5/5. 3.75/1.25 ohms. 30 db. contin. Flat to 17,000 Cy. w/Diag. & Inst. for 6 watt or PAR 807's #9446 \$11.65

Xmfrs VFO

4-5.3 MC \$5.95 Drivers 5.3-7 MC \$5.95 40 Watts 7-9.1 MC \$13.95 Output 274N (ARC5) Used Good Cond.

All merch. guar. Mail orders promptly filled. All prices F.O.B. N. Y. C. Send MO or Chk. Only shipping chgs. sent C.O.D. Rated concerns send P. O.

COMMUNICATIONS EQUIPMENT CO. MIN. ORDER \$3.00

131 Liberty St., New York, N. Y. Dept. E-3 Chas. Rosen Phone: Digby 9-4124





# LIFE ELECTRONICS

OFFERS  
HUGE INVENTORIES



## IPC UG CONNECTORS KINGS

We carry the largest stock of "JAN" Approved UG Connectors in the country



AN No.	Price Each	AN No.	Price Each	AN No.	Price Each	AN No.	Price Each	AN No.	Price Each	AN No.	Price Each
UG9/U	1.25	UG35A/U	20.00	UG97/U	4.00	UG174/U	20.00	UG245/U	2.80	UG352/U	7.50
UG10/U	1.95	UG36/U	20.00	UG97A/U	4.25	UG175/U	18	UG246/U	3.10	UG352A/U	7.95
UG11/U	1.80	UG37/U	20.00	UG98/U	1.95	UG176/U	18	UG249/U	16.20	UG406/U	6.75
UG12/U	1.25	UG37A/U	20.00	UG98A/U	2.30	UG180/U	6.95	UG250/U	16.20	UG407/U	5.25
UG13/U	1.95	UG38A/U	25.00	UG100/U	2.95	UG181A/U	6.95	UG251/U	16.20	MT412/U	.95
UG14/U	1.80	UG39/U	1.60	UG100A/U	3.30	UG182A/U	6.95	UG252/U	6.00	UG413/U	15.00
UG15/U	1.25	UG40/U	1.75	UG101/U	3.70	UG185/U	1.35	UG253/U	5.50	UG414/U	2.95
UG16/U	1.95	UG45/U	2.50	UG101A/U	4.00	UG188/U	1.35	UG254/U	3.55	UG415/U	11.00
UG17/U	1.80	UG46/U	2.50	UG102/U	.90	MX195/U	1.00	UG254A/U	3.55	UG416/U	10.00
UG18A/U	1.25	UG57/U	2.30	UG103/U	.90	UG197/U	5.50	UG255/U	1.95	UG421/U	3.25
UG18B/U	1.95	UG57B/U	1.95	UG106/U	.15	UG201/U	2.05	UG256/U	13.75	UG422/U	3.25
UG19/U	1.60	UG58/U	.80	UG107/U	2.75	UG202/U	3.45	UG257/U	13.75	UG423/U	5.80
UG19A/U	1.70	UG58A/U	.90	UG107A/U	2.80	UG203/U	.85	UG260/U	1.25	UG475/U	25.00
UG19B/U	1.95	UG59/U	2.45	UG107B/U	3.50	UG204/U	3.50	UG261/U	1.25	UG479/U	26.00
UG20/U	1.45	UG59A/U	2.25	UG108/U	2.25	UG204A/U	3.50	UG262/U	1.35	UG482/U	26.00
UG20A/U	1.60	UG60/U	2.40	UG108A/U	2.80	UG206/U	2.50	UG269/U	3.75	UG483/U	4.30
UG20B/U	1.75	UG60A/U	1.75	UG109/U	2.30	UG207/U	22.50	UG270/U	8.50	UG484/U	5.95
UG21/U	1.25	UG61/U	2.55	UG109A/U	2.25	UG208/U	22.50	UG271/U	8.50	UG486/U	2.50
UG21A/U	1.35	UG61A/U	2.25	UG110/U	12.50	UG212/U	5.60	UG272/U	20.00	UG487/U	6.95
UG21B/U	1.45	UG62/U	35.00	UG114/U	1.95	UG212A/U	5.00	UG273/U	1.75	UG491/U	2.25
UG21C/U	1.50	UG83/U	1.90	UG115/U	1.95	UG213/U	4.20	UG274/U	2.50	UG492/U	5.00
UG22/U	1.35	UG85/U	2.05	UG119/UP	7.50	UG213A/U	3.75	UG275/U	5.95	UG493/U	7.25
UG22A/U	1.70	UG86/U	2.10	CW123/U	.63	UG215/U	4.50	UG276/U	5.95	UG494/U	4.95
UG22B/U	1.75	UG87/U	1.75	UG131/U	4.70	UG216/U	10.85	UG277/U	3.50	UG495/U	6.00
UG23/U	1.25	UG88/U	1.25	UG146/U	2.55	UG217/U	5.50	UG287/U	6.90	UG496/U	3.26
UG23A/U	1.60	UG89/U	1.25	UG154/U	8.50	UG218/U	8.10	UG290/U	1.15	UG498/U	1.35
UG23B/U	1.65	UG90/U	1.35	CW155/U	.63	UG219/U	5.60	UG291/U	1.30	UG499/U	1.25
UG27A/U	2.95	UG91/U	1.75	UG155/U	6.95	UG220/U	8.10	UG306/U	2.95	MX504/U	.45
UG27B/U	3.15	UG92/U	1.40	UG156/U	6.75	UG222/U	43.75	UG309/U	3.75	UG526/U	2.75
UG28A/U	2.95	UG92A/U	1.95	UG157/U	6.75	UG224/U	1.85	UG312/U	2.75	UG530/U	4.50
UG28B/U	3.15	UG93/U	1.75	UG158/U	47.50	UG231/U	2.50	UG327/U	12.75	UG531/U	5.15
UG29A/U	1.55	UG93A/U	1.75	UG159A/U	1.95	UG233/U	16.20	UG332/U	2.00	UG532/U	5.75
UG29B/U	2.35	UG94/U	1.75	UG160/U	2.40	UG234/U	16.20	UG333/U	6.50	UG533/U	5.50
UG30/U	2.50	UG94A/U	1.50	UG160A/U	2.40	UG235/U	35.60	UG334/U	7.30	UG534/U	16.50
UG32/U	20.00	UG95/U	1.75	UG166/U	47.50	UG236/U	9.40	UG335/U	2.75	UG535/U	4.95
UG33/U	20.00	UG95A/U	1.75	UG167/U	4.50	UG237/U	16.20	UG342/U	2.25	UG536/U	2.45
UG34/U	21.75	UG96/U	1.60	UG167A/U	5.30	UG241/U	3.45	UG344/U	3.50	MX554/U	2.25
		UG96A/U	1.75	UG173/U	.38	UG242/U	4.10	UG348/U	1.25	MX564/U	.55
						UG244/U	4.40	UG349/U	2.95	MX913/U	.65

### "UHF" COAXIAL CABLE CONNECTORS

The following low loss RF connectors and adapters have been especially designed for use with RG coaxial cable. There is a connector for every RF and UHF application.



No.	Jan. No.	Description	1-99	100 or more
83-1SP	PL259	Plug	.55	.50
83-168	UG176U	Adapter	.18	.17
83-185	UG175U	Adapter	.18	.17
83-1SPN	PL259A	Plug	.60	.55
83-776	UG203U	Plug	.85	.75
83-1R	SO239	Receptacle	.55	.50
83-1RTY		Receptacle	.75	.65
83-1H	UG106U	Hood	.27	.24
83-1HP		Hood	.12	.10
83-1AC	UG177U	Hood	.31	.25
83-1AC		Cap and chain	.61	.50
83-1BC		Cap and chain	.35	.31
83-1T	M358	"T" connector	1.50	1.40
83-1AP	M359A	Angle adapter	.55	.50
83-1J	PL258	Junction	1.00	.90
83-1F	PL274	Feed thru	1.50	1.40
83-22SP	UG102U	Twin plug	.90	.80
83-22R	UG103U	Twin receptacle	.90	.80
83-22AP	UG104U	Twin ang. adapter	1.40	1.25
83-22J	UG105U	Twin junction	1.50	1.40
83-22T	UG106U	Twin "T"	1.65	1.50
83-22F	PL275	Twin feed thru	2.00	1.80
83-2SP	PL295	Large twin plug	1.94	1.75
83-2R	SO265	Large twin recept.	1.44	1.30

### "AN" CONNECTORS

We have over 300,000 assorted "AN" connectors having the 5 basic shell types illustrated. Send us your requirements.



### COAXIAL CABLES

Life offers the most comprehensive inventory of brand new, Jan approved cables by leading manufacturers.



RG. No.	Impedance	Price Per Thousand Ft.	RG. No.	Impedance	Price Per Thousand Ft.
RG5U	52.5 ohms	\$100.00	RG25U	48.00 ohms	\$495.00
RG6U	76.0 ohms	160.00	RG27U	48.0 ohms	450.00
RG7U	97.5 ohms	120.00	RG29U	53.5 ohms	50.00
RG8U	52.0 ohms	135.00	RG34U	71.0 ohms	250.00
RG9U	51.0 ohms	247.00	RG39U	72.5 ohms	180.00
RG10U	52.0 ohms	245.00	RG41U	67.5 ohms	400.00
RG11U	75.0 ohms	175.00	RG54A	58.0 ohms	75.00
RG12U	75.0 ohms	245.00	RG55U	53.5 ohms	110.00
RG13U	74.0 ohms	225.00	RG57U	95.0 ohms	125.00
RG14U	52.0 ohms	300.00	RG58U	53.5 ohms	70.00
RG17U	52.0 ohms	650.00	RG59U	73.0 ohms	70.00
RG18U	52.0 ohms	950.00	RG62U	93.0 ohms	75.00
RG19U	52.0 ohms	1250.00	RG63U	93.0 ohms	75.00
RG20U	52.0 ohms	1550.00	RG65U	125.0 ohms	175.00
RG21U	53.0 ohms	195.00	RG65U	950.0 ohms	650.00
RG22U	95.0 ohms	150.00	RG71U	93.0 ohms	200.00
RG24U	125.00 ohms	450.00	RG74U	52.0 ohms	250.00
			RG77U	48.0 ohms	80.00
			RG78U	48.0 ohms	80.00

ALL PRICES F.O.B. NEW YORK  
Prices subject to change without notice.  
Please add Government "D.O." Priorities where applicable.

ADD 25% TO PRICES SHOWN FOR LENGTHS UNDER 500 FEET OF A TYPE.

# LIFE ELECTRONIC SALES

345 Broadway, New York City  
Digby 9-4154

# NEW YORK'S RADIO TUBE EXCHANGE

TYPE	PRICE	TYPE	PRICE	TYPE	PRICE	TYPE	PRICE	TYPE	PRICE	TYPE	PRICE	TYPE	PRICE
OA2	3.00	2J22	29.95	5CP1	4.95	327A	3.95	721A	2.95	851	39.50	1280	1.95
OA3	1.50	2J26	17.75	5D21	15.00	350A	7.95	722A	1.95	860	15.00	1611	1.95
OA4G	1.35	2J27	29.95	5J23	45.00	350B	5.95	723A/B	14.95	861	39.50	1613	1.08
OB2	3.00	2J31	39.95	5J29	19.95	357A	37.50	724A	2.95	866A	1.79	1616	2.95
OC3	1.50	2J32	69.95	5JP1	37.50	368AS	3.95	724B	3.95	869B	29.50	1619	.89
OD3	1.50	2J36	105.00	5JP2	17.50	371B	1.95	725A	6.95	872A	3.95	1620	5.95
1A3	1.00	2J38	17.95	5JP4	27.50	385A	4.95	726A	6.95	876	.90	1622	2.75
G1A	4.95	2J42	150.00	5LP1	18.95	388A	2.95	726B	36.00	878	1.95	1624	2.00
G1B	6.95	2J49	109.00	6C21	39.50	393A	8.95	726C	69.00	884	1.95	1625	.45
1B21A	2.75	2J50	69.50	C6A	3.95	394A	8.95	728AY	27.00	885	1.75	1851	1.95
1B22	3.95	2J61	75.00	7BP7	5.95	MX408U	.75	730A	8.95	889R	199.50	8012	4.25
1B23	9.95	2J62	75.00	7DP4	10.00	417A	7.95	800	1.00	913	12.95	8013	2.95
1B24	17.95	2K25	47.50	12AP4	55.00	434A	6.95	801A	1.00	914	75.00	8013A	5.95
1B26	2.95	2K28	37.50	15R	.95	446A	1.95	802	3.60	931A	8.95	8014A	29.95
1B27	17.95	2K29	27.50	NE16	.45	446B	2.95	803	2.95	954	.15	8020	3.50
1B32	4.10	2K45	499.50	FG17	3.95	450TL	45.00	805	5.95	955	.55	8025	5.95
1B38	33.00	2V3G	2.10	RX21	2.95	464A	9.95	807	1.69	956	.69	9001	1.75
1B42	5.95	3A5	1.25	RK39	2.95	471A	2.75	808	3.95	957	.19	9002	1.50
1B56	49.95	3B24	3.50	RK60	2.95	527	25.00	809	2.45	958A	.49	9003	1.75
1B60	4.95	3B24W	5.50	RK72	1.95	WL530	12.50	810	11.00	959	.69	9004	.75
1N21	1.35	EL3C	5.95	RK73	1.95	WL531	3.50	813	7.95	975A	17.95	9005	1.90
1N21A	1.75	3C22	59.50	FG95	18.00	701A	7.50	814	3.95	991	.45	9006	.35
1N22	1.75	3C23	10.95	100TH	9.00	703A	3.95	815	3.25				
1N23	2.00	3C24	2.50	FG105	19.00	705A	2.95	827R	27.50				
1N23A	3.75	3C45	12.95	F123	8.95	706AY	48.50	829	9.95				
1N23B	7.00	3DP1/A	7.95	203A	8.95	706CY	48.50	829A	11.95				
1N26	5.00	3E29	15.50	211	.75	707A	17.95	829B	14.95				
1N27	5.00	SN4	5.50	217C	18.00	707B	27.00	832	5.95				
1N48	1.00	4A1	1.75	242C	10.00	714AY	5.95	832A	9.95				
1S21	6.95	4C27	10.80	249C	4.95	715A	7.95	833A	49.95				
2B22	4.95	4J25	199.00	250TL	19.95	715B	9.95	834	7.95				
2B26	3.75	4J26	199.00	274B	3.00	715C	25.00	836	4.95				
2C34	.35	4J30	395.00	304TH	12.00	717A	1.75	837	2.95				
2C43	27.00	4J31	99.00	307A	4.95	718AY/EY	48.50	838	4.95				
2C44	.90	4J37	99.00	310A	7.95	720A/B/C/D/Y	95.00	845	5.95				
2C51	5.95	4J38	89.00	312A	3.95			849	32.50				
2D21	1.75	4J39	99.00										
2E22	3.75	4J41	99.00										
2E30	2.75	4J62	99.00										
2F21	40.00	C5B	2.95										
2J21A	29.95	5BP4	4.95										



350 is a long life WE807  
 350B is a long life WE6L6G  
 WE 701A can be used for a Super 813  
 \$25.00 Minimum Order

PHONE WORTH 4-8262 135 LIBERTY ST., NEW YORK 6, N.Y.

# NEW YORK'S RADIO TUBE EXCHANGE

## ATTENTION PURCHASING AGENTS AND BUSINESS MANAGERS

WE BUY—WE SELL—WE EXCHANGE.—WILL PAY CASH FOR YOUR INVENTORY NO MATTER HOW SMALL OR LARGE.—TURN YOUR OVERSTOCKED ITEMS INTO CIRCULATION.

**Microwave K Band 2400 MC.**  
 TSKI-SE Spectrum Analyzer  
 K Band Flap Attenuator

**X Band**

TS 12 Unit 1 USWR Measuring Amplifier, 2 channel  
 TS 12 Unit 2 Plumbing for above TS13  
 TS 33 X Band Power and Frequency Meter  
 TS 35 X Band Pulsed Signal Generator  
 TS 36 X Band Power Meter  
 TS 45 X Band Signal Generator  
 TS 146 X Band Signal Generator  
 TS 263 Navy Version of TS 146  
 TS 108  
 X Band Magic T Plumbing  
 X Band Tunable Crystal Mounts

**S Band**

TS3A/AP S Band Power and Frequency Meter

RF 4 Electrically Tuned S Band Echo Box  
 BC 1277/60ABQ S Band Pulsed Signal Generator  
 PE 102 High Power S Band Signal Generator

**L Band**

Hazeltine 1030 Signal Generator 145 to 235 Megacycles  
 Measurements Corp. type 84 Standard Signal Generator  
 TS 47, 40 to 400 MC Signal Generator

**Broadcast Wave Bands**

162C Rider Chanalyst  
 Short Wave Adapter for 162C  
 TS 174 Signal

**Oscilloscopes**

BC 1287A used in LZ sets  
 TS 34 Oscilloscopes WE Supreme 564

**Audio Frequencies**

RCA Audio Chanalyst

**Other Test Equipment and Meters**

TS 15/A Magnet Flux Meter  
 General Radio V T Voltmeter 728A  
 Calibrator WE I-147  
 General Radio 1000 cycles type 213  
 Limit Bridges  
 Boonton Standard Inductances  
 Weston Meters types 430, 429, 741  
 Model 40 Pyrometer  
 Rawson, meters 0-10 Microampere 0-2 Millivolt

**RADAR Sets & Parts**

APS 3—APS 4—SCR 284  
 R-111/APR5A Receivers



PHONE WORTH 4-8262 135 LIBERTY ST., NEW YORK 6, N.Y.



**WANTED:**

**RESISTORS and POTENTIOMETERS**

MADE BY

**ALLEN BRADLEY  
COMPANY**

*all types and values*



*also*

**CARBON RESISTORS**

*other makes Domestic and Foreign  
all types and values*



**WE PAY HIGHEST PRICES**

**LEGRI S COMPANY**

130 WEST 102nd STREET  
NEW YORK 25, N. Y.  
Phone: ACademy 2-0018

# CONDENSERS

OIL-PAPER  
CERAMICONS  
MICA-SILVER

IN COMMERCIAL QUANTITIES - IMMEDIATE DELIVERY

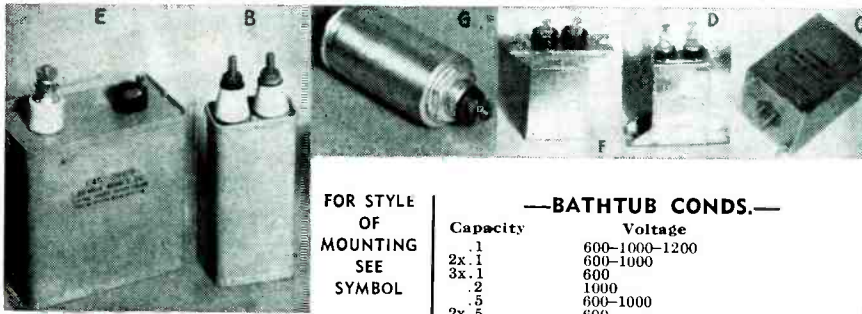

FOR STYLE OF MOUNTING SEE SYMBOL

### OIL CONDENSERS—NEW

Symbol	Capacity	Voltage	Type	Price
B	.005-.005-.01	10KV	#26F344	3.50
	.012	25KV		14.50
	.02	20KV		11.50
E	.03	10KV	#26F380	8.75
B	.05-.05	2000VAC		1.10
B	2x.075	7500V		11.75
B	.08	12.2KV		12.75
F	.1	1500V		.49
F	.1	2000V	1 Term	.32
F	.1	2500V		.59
G	.1	7000V		1.25
E	.1	7500V	#25F175	1.25
B	.1	7500V	#25F469	1.59
B	2x.1	7500V		2.35
B	.1	10KV	#23F644	7.95
B	.1	15KV	#25F572	12.50
B	2x.1	3000V		1.75
B	.2	10KV	#25F133	8.95
B	.25	3000V	Round Can	1.50
B	.25	6000V	#23F350	1.50
E	.25	6000V	25F639	17.50
B	.25	18KV		21.95
B	.25	20KV		17.50
B	.25	32.5KV		31.95
B	.4	10KV		9.95
B	.5	750VAC	(2000 VDC)	.75
B	.5	2000V	(Small)	1.65
B	.5	3000V	CF7C	2.35
B	.5-.1	25KV		29.95
B	1	2000V	3 Terms	.89
B	1	1000V		.59
B	1	1500V		.98
B	1	2000V		1.25
B	1	2500V		2.25
B	1	3000V		2.75
B	1	5000V		3.25
B	1	6000V		4.50
B	1	15KV		19.95
B	1	20KV		39.95
B	1	25KV		48.95
B	2	600V	#26F407	.50
B	2	600V	TLAD	.59
B	2	1000V		.79-1.25
B	2	1000V	TLA	1.25
B	2	1500V		1.75
B	2	2500V	Brackets	2.75
B	2	4000V		4.95
B	2	5000V		10.95
B	2-2	10KV		17.50
B	3	600V	4 Terms	.89
B	3	600V	Rd Can	.42
B	3	2000V		3.95
B	3	4000V		5.25
B	2x3	150V		.75
B	4	440VAC		.65
B	4	400V		1.25
B	4	600V	TLA	.95-1.35
B	4	600V		1.25
B	4	1000V		1.69
B	4	1500V		2.75
B	3x4	600V	4 Terms	1.30
B	5	60V		.90
B	5	330VAC	Pyranol	1.05
F	5-5	600V		1.15
B	6	600V		2.95
B	6	1500V		3.35
B	6	2000V		1.25
B	7	600V	Brackets	1.45
B	7	800V		1.20
F	8	500V		1.45
B	8	600V	Brackets	1.45
B	8	600V		1.39
O	8-8	1000V		1.95
B	8	600V		.98
F	10	600V		1.85-2.35
B	10	330VAC	Pyranol	1.80
B	10	1000V		3.05
B	12	1000V		3.50
B	15	1000V	Brackets	4.25

### —BATHTUB CONDS.—

Capacity	Voltage
.1	600-1000-1200
2x.1	600-1000
3x.1	600
.2	1000
.5	600-1000
2x.5	600
1	600-1000 Boxed
2	400-600

SPECIAL—.2 mfd—1000 V. ST \$1.19  
SPECIAL BATHTUB KIT 15 @ \$1.00

Quotations submitted. Other types available

### CHANNEL CONDENSERS—NEW

Capacity	Style	Voltage	Price
2x.05	BT	600	.28
.1	BT	500 Pyranol	.34
.1	BT	600	.34
2x.1	BT	2500	.59
2x.1	BT	600	.38
3x.1	BT	400	.38
.25	BT	400	.26
.25	BT	600	.31
.25	BT	1000 Pyranol	.42
.4	BT	600	.28
.5	TT	400	.19
.5	TT	500 Pyranol	.39
.5-1	BT	600	.39
5-1	BT	400	.34
1	BT	400 Pyranol	.30
1	BT	500 Pyranol	.35
1	BT	500 Pyranol	.35
1	BT	600	.39

### SPECIAL

.5 mfd—400 V CT 63, TT \$1.19

### —NEW MICA CONDS.—

6	140	500	3900
8	160	510	4000
10	185	600	4700
15	200	650	5000
25	230	750	6500
34	240	1000	7960
39	250	1500	9100
50	300	2000	10,000
70	350	2400	
75	300	3000	
100	400	3700	
	.6 mmfd to	750 mmfd	.045
	1000 mmfd to	7960 mmfd	.05
	9100 mmfd to	10,000 mmfd	.18

SPECIAL MICA KIT—100 @ \$2.95

### —SILVER MICA CONDS.—

15	300	1500	
20	330	2000	
25	390	2900	
50	400	4000	
60	450	4900	
75	500	5000	
95	510		
120	150	950	
150	240	1000	
240	250	1400	
270		1450	
	15 mmfd to	510 mmfd	.08
	950 mmfd to	5000 mmfd	.09

SPECIAL MICA KIT—100 @ \$5.95

### SPECIAL \$1.75 Type "JJ" Pots

Ohms	Shaft
1500	1/4
1 Meg.	1/2

### TYPE "JJ" POTS. \$.75—\$1.15

Ohms	Shaft	Ohms	Shaft
50	1/8 S	15,000	1/8 S
300	3/8 R	20,000	1/8 LS
400	1/8 LS	20,000	1/4 R
500	3/8 S	20,000	3/8 S
1000	1/8 LS	25,000	1/8 LS
2000	1/8 LS	25,000	1/8 SR
2500	1/2 R	50,000	1/8 LS
3000	1/8 LS	50,000	1/8 S
5000	1/8 LS	50,000	1/4 S
10,000	3/8 R	100,000	3/8 R
10,000	1/8 LS	100,000	1/8 LS
		150,000	2 1/8 R
		200,000	1 1/8 LS
Other types Available		250,000	1/8 S
		250,000 Knurled	1/4 R
		1 Meg	1/8 S

Symbols:— LS—Locking Shaft S—Screwdriver R—Round

### BAKELITE TOGGLE SWITCHES

SPST 3A. 250V, 3/4" Bushing 1/8" SD Shaft.	\$.15
SPDT C-H 8800 K4, 7/16" Bushing, Bat Handle (on-off on)	\$.39
DPST 3A. 250 V. 7/16" Bushing, Bat Handle.	\$.38
DPST C-H 8823 K4, 7/16" Bushing, Bat handle.	\$.48
DPDT C-H 8824 K4, 7/16" Bushing, Bat Handle	\$.52

### —COAX CONNECTORS—

83-1AP	\$1.19	83-1SPN	.39	83-1J	.64
83-1SP					

SPECIAL—Coax Assembly RG-59/U length 6", connected with 83-1SPN, 83-1J and Amphenol type 80-M connector \$1.79. Less 83-1J \$.23

### NEW—BC—906 FREQ. METER—NEW

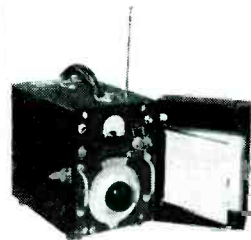

Range 150-225 MC—Bat. operation with precision velvet vernier dial, tuning charts, 0-500 D.C. micro-ammeter, diode-Triode and plug-in antenna. Contained in black aluminum carrying case 12 1/2 x 8 3/4 x 6 1/2. Price \$15.95.

## MONMOUTH RADIO LABORATORIES

BOX 159

OAKHURST, N. J.

ALL PRICES SUBJECT TO CHANGE WITHOUT NOTICE



# TEST EQUIPMENT

X Band Spectrum Analyzer 8500-9600 Mc., calibrated linear below cut-off attenuator, calibrated frequency meter, tuned mixer, 4 i.f. stages, 3 video stages overall gain 125 db., regulated power supply.

S Band Spectrum Analyzer 2700-3900 Mc., similar to above.

K Band Test Load, low power....\$20.00

X Band Test Load, 50 watts, average power  $\frac{1}{2}$ " x 1" waveguide. Sand load TS 108.....\$35.00

HI POWER X BAND TEST LOAD, dissipates 350 watts of average power for  $\frac{3}{8}$ " x  $1\frac{1}{4}$ " waveguide, VSWR less than 1.15 between 7 and 10 KMC \$150.00

Dummy Load, DA-21/U, X Band, High Power Load, VSWR less than 1.15. 7 to 10 KMC. Dissipates 280 watts average power.

Dummy Load, TS-338/U2, S Band, High Power Load, 2500 to 3700 mc. Dissipates 600 watts average power. For  $1\frac{1}{2}$ "x3" waveguide.

X Band VSWR TEST SET, TS-12/AP, complete with linear amplifier, direct reading VSWR meter, slotted wave guide with gear driven travelling probe, matched termination and various adapters, with carrying case.

X Band Pick-up Horn, AT-48/UP with coaxial fitting .....\$10.00

X Band Below Cut-Off Wave Guide Attenuator, with calibrated dial, type N input connector, output connects to  $\frac{1}{2}$ " x 1" wave guide.....\$55.00

TS-62 X Band Echo Box with r.f. cable and pick-up antenna.

TS-33 X Band Frequency Meter, 8500-9600 Mcs. Crystal detector and 50 micro-amp. meter. Indicates Resonance. Connection for scope available.

TS-45A-APM-3 Signal Generator, 8700-9500 mc., 110 V. 60-800 cps.

TS-35/AP X Band Signal Generator, pulsed, calibrated power meter, frequency meter, 8700-9500 mc.

30 MC I.F. STRIP, VIDEO, and AUDIO AMPLIFIER AND 110 Volt 60-2600 cps POWER SUPPLY, Bandwidth 10 mc. new, part of SPR-2 Receiver.

AMPLIFIER STRIP AM-SSA/SPR-2 contains I. F. amplifier, detector, video amplifier, pulse stretcher and audio amplifier and Rectifier Power Unit PP-155A/SPR-2 bandwidth 10 mc. center frequency 30 mc. sensitivity 50 microvolts for 10 milliwatts output. Power supply 80/115 V ac. 60-2600 cps 1.3 amps. Send for schematic \$65.00 less tubes.

S Band Signal Generator Cavity With Cut-Off Attenuator, 2300-2950 mc., 2C40 tube, with modulator chassis \$30.00

High Pass Filter F-29/SPR-2, cuts off at 1000 mc. and below; used for receivers above 1000 mc.....\$12.00

UPN-1 S Band Beacon Receiver-Transmitter .....\$75.00

S Band Test Load TPS-55P/BT, 50 ohms \$12.00

High Pass Filter F-29/SPR-2, cuts off at 1000 mc and below; used for receivers above 1000 mc.....\$12.00

TS-125 CALIBRATED S BAND POWER METER with attenuator.

TS-155 S BAND SIGNAL GENERATOR and Power Meter.

S Band Mixer, tunable by means of slider, type N connector for the R. F. and local oscillator input, U.H.F. connector for the I.F. output, variable oscillator injection .....\$30.00

TS-110 S Band Echo Box 2400-2700 mc, portable .....\$110.00

HI POWER S BAND TEST LOAD, dissipates 1000 watts of average power, for  $1\frac{1}{2}$ " x 3" waveguide. Range 2500 to 3700 MC.

X Band Thermistor Mounts, VSWR less than 1.4 8500-9600 MC Fixed triple tuned,  $\frac{1}{2}$ "x1" waveguide.....\$40.00  
Fixed triple tuned  $\frac{3}{8}$ "x $1\frac{1}{4}$ " waveguide .....\$50.00

Frequency Meter, 8500-9600, variable, absorption type for either  $\frac{1}{2}$ "x1" or  $\frac{3}{8}$ "x $1\frac{1}{4}$ " waveguide, with calibration,  $\pm$  4 MC, precision ground thread.\$150.00

X Band Crystal Mount,  $\frac{1}{2}$ "x1" waveguide .....\$25.00

X Band Attenuator, double van type, VSWR less than 1.4, 8500-9600 MC 0-30db, calibrated for  $1\frac{1}{4}$ "x $\frac{3}{8}$ " waveguide .....\$80.00  
 $\frac{1}{2}$ "x1" to  $\frac{3}{8}$ "x $1\frac{1}{4}$ " adapter, UG80/U \$5.00

TS-203/AP CALIBRATED SELSYN..\$10.00

GENERAL RADIO PRECISION WAVE-METER TYPE 724A, range 16 kc to 50 mc. 0.25% accuracy, V.T.V.M. resonance indicator, complete with accessories and carrying case NEW....\$175.00

HEWLETT-PACKARD-AUDIO SIGNAL GENERATOR 205A.....\$230.00

ESTERLINE Angus recording Milliammeter 60 cycles, 110V. AC. 1 ma full scale. \$150.00

TS-89 Voltage Divider for measuring high video pulses, ratios 1:10 and 1:100 transmission flat within 2 db 150 c.p.s. to 5 mc., with cable for attaching to syndroscope.

Waveguide Below Cut-off Attenuator L 101-A U.H.F. Connectors at each end calibration 30-100 db.....\$15.00

WAVEGUIDE BELOW CUT-OFF ATTENUATOR same as above except input is matched in range of 2200-3300 mc. VSWR less than 1.2.....\$54.00

PULSE TRANSFORMER 132-AWP...\$8.00

HYPERSIL CORE CHOKE, 1 Henry, Westinghouse L-422031 or L 422-32....\$3.00

PULSE INPUT TRANSFORMER, permalloy core, 50 to 4000 kc., WE-D161310, impedance ratio 120 to 2350 ohms..\$3.00

# RADAR EQUIPMENT

## Search Radars

APS-2; APS-3; APS-4; APS-15;  
SCR-717B; SCR-720; APQ-13;  
APR-1 Receiver & Tuning Units  
APR-4 Receiver & Tuning Units

APR-5 Receivers

TPX-1 IFF Transmitters—Receivers

R-69/APN-9 Loran Receivers

CPN-6 3cm Radar Beacon

AN/APG-13 Complete New

SO-9 1cm Search Radar

APG-8 Units; AS-168/AP Antenna;

BC1153 Indicators; BC 1157A

Control Boxes;

CA-4 Turbo Amplifiers; CN-21

APA-15A;

MD-12A/AP013 Modulators;

RA-10DB Receivers;

RF-4A/AP Antenna Boxes; RT-39/

APG Recvr-Trans.;

RT-48A/TPX-1 Recvr.-Trans.

## TEST EQUIPMENT

TS-3/AP; TS-14/AP

TS-15/AP; TS-16/APN

TS-19/APQ; TS-23/APN;

TS-24/APR-Z

TS-26/TSM; TS-27/TSM; TS-33/AP

TS-35/AP; TS-36/AP; TS-45

TS-47/APR; TS-59

TS-61/AP; TS-62/AP; TS-74/VPM

TS-76/APM-3; TS-91; TS-98

TS-100/AP; TS-102; TS-111/CP

TS-118/AP; TS-125/AP; TS-126/AP

TS-127/V; TS-131/AP;

TS-159/TPX-1

TS-146; TS-155/VP; TS-218/AP

TS-203A/P; TS-206/AP; TS-226/AP

TS-268/VB; BC-376H

BC-905; BC-906; BC-978

BC-1277; BC-1236A; APA-11

LS-1 Frequency Meter

LM-15 Frequency Meter

804 Measurement Corpor.

Signal Generator

Test Equipment and Signal Generators

for 10 and 3 cm

1-208 FM Signal Generator

All types of Magnetrons

Write for listing

LERU LABORATORIES, INC.

360 BLEECKER ST.

NEW YORK 14, N. Y.

Oregon 5-3525

# ELECTRO IMPULSE LABORATORY

62 White Street

Red Bank 6-0404

Red Bank, N. J.

# Over 200,000 RELAYS in our Vast Stock—Guaranteed—HERE'S A FEW

## MINIATURE RELAYS



**AUTOMATIC** ZH77628-14 12VDC. Make one, Break two, 640 ohms Dual Telephone Contacts #R1244 ..... \$ .85 ea  
**GUARDIAN** 24VDC, SPST n.o. 300 ohm #R106 ..... .59 ea  
 G.E. 7472679 3VDC SPST n.o. 30 ohm #R159A ..... .59 ea  
**COOK** 55526 24VDC Makes 2, Breaks 1, 300 ohm Ceramic Insulation #R107 ..... .95 ea  
**ALLIED** 55837 24VDC Double Make, 250 ohm #R108 ..... 1.50 ea  
 G.E. 55837 Same as #R108 #R109G ..... 1.00 ea  
**RBM** 55837 Same as #R108 #R108R ..... 1.25 ea  
**RBM** 55589 24VDC DPST n.o. 250 ohm #R245 ..... 1.25 ea  
**CLARE** A13415 12VDC DPST n.o. 120 ohm #R246 ..... 1.25 ea

## ANTENNA SWITCHING RELAYS



G.E. 37843 12VDC DPDT & SPST n.c. Ceramic Insulation 50 ohms 10A contacts #R137 ..... \$1.95 ea  
**ADVANCE** 4001B 15VDC DPDT & SPST n.o. Ceramic Insulation 2500 ohms 15A Contacts #R227 ..... 3.95 ea  
**LEACH** 1054B 24VDC DPST n.o. 265 ohms 10A contacts #R110 ..... 1.25 ea  
**LEACH** 1027BF 24VDC DPDT 250 ohms 10A Contacts #R228 ..... 1.95 ea  
**LEACH** 1421-174 24VDC Double Make 200 ohms 10A contacts HI Voltage Ceramic Insulation #R07 ..... 1.95 ea  
 G.E. CR2791D107F3 24VDC DPDT Ceramic Insulation 100 ohms 5A Contacts #R229 ..... 11.95 ea

## A. C. RELAYS

**GUARDIAN** 24VAC Make 2, Break 1 5A Contacts #R273 ..... \$1.10 ea  
**GUARDIAN** 24VAC SPST n.o. 5A Contacts #R274 ..... .98 ea  
**ALLIED** B00A35 55VAC DPDT 10A Contacts #R211 ..... 1.69 ea  
**12VAC DPST** n.o., 5A Contacts, #R275 ..... .98 ea  
**COOK** 319318-60 110VAC Make 2, Break 1, 1A Contacts Octal Plug-in Base #R272 ..... 2.65 ea



**G.E. 1500V C.T. 150 MA**

2 x 6.3V at 2.5A 5V at 3A. Excellent for Arc-5; 274N; 807 or 1625 Power Supply. Shipping Wt. 12 lbs. No. T85 ..... \$5.29 ea.

## W. E. TRANSTAT

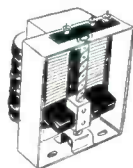

W.E. D122855 400 cy. Voltage Regulator. Input: 115VAC. Output: 92-115VAC, 5.5A #T281 ..... \$6.75 ea  
 10 for ..... \$60.00



## SERVO OUTPUT XFMR'S

PP6L6 to Servo mechanism with 10% feed-back winding. MU metal core \$3.50 ea  
**DUAL** unit PP6L6 to Servo mechanism with 10% feed-back winding and 6SN7 to Servo mechanism. Both in 1 can ..... \$3.95 ea



**SINE - COSINE - SQUARE WAVE POTENTIOMETER** W. E. CO# D169100 for very low freq. sweep circuits .. \$9.95 ea.

SAVE 50% AT U.G.

## SILVER MICAS

MMF TOL	EA	250	±10%	.09
8.5	±10%	1500	±1%	.35
25	±5%	1700	±10%	.15
125*	±1%	2500	±10%	.15
		5600	±10%	.20

\* on mounting block

## SOLENOIDS

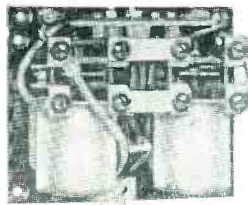

**GUARDIAN** 34585 Dual latching 24VDC each section: double make—one, double break—one, alternate double make—one, break—one 100A 24 ohms #R223 .. \$8.75 ea

**ALLEN BRADLEY** B5A 24VDC SPST 50A 100 ohms #R105 ..... \$1.95 ea  
 G.E. CR9533K 100A2 24VDC 2 Switchettes DPST n.c. & SPST n.o.; extra long throw #R132 ..... 9.95 ea  
**HART** M569A Cat #694R19 24VDC SPST 200A 75 ohms #R127A ..... 2.95 ea  
**AUTOLITE** B8 SPEC #32424A 24VDC SPST 200A 6 ohms #R128 ..... 2.75 ea  
**CUTLER-HAMMER** B8 6041H130A 24VDC SPST 200A 10 ohms #R130 ..... 3.95 ea  
**SQUARE O** B5A 24VDC SPST 50A 150 ohms #R25 ..... 2.25 ea  
 G.E. CR2792D116W2 12VDC SPST 100A 30 ohms Plastic Enclosed #R230 ..... 5.50 ea  
**EPCO** S47D 12VDC SPST 25A 35 ohms #R122 ..... 2.95 ea  
**ECLIPSE** D1EA53538 24VDC 200A 6 ohms #R126 ..... 2.95 ea  
**RBM** BN5 24VDC 50A 200 ohms #R24 ..... 1.95 ea  
**WARD LEONARD** N83 110V 60 Cya. 5 double make contacts 3 at 50A. 2 at 30A #R233 ..... 10.95 ea



## ALLIED TYPE BO RELAYS

B06A35 55VAC (or 12VDC) DPDT #R211 ..... \$1.69 ea  
 B06D35 24VDC DPDT 240 ohms #R04 ..... 1.75 ea  
 B0635 24VDC DPDT 240 ohms #R04 ..... 1.69 ea  
 B013D35 24VDC SPST Double Make 240 ohms #R06 ..... 1.25 ea  
 D09D28 6VDC 3PDT 14 ohms #R225 ..... 2.25 ea  
 B1X-42 12 or 24VDC SP Dble Break 240 ohms C.T. #R228 ..... .89 ea  
 55837 24VDC Double Make 250 ohms #R108 ..... 1.50 ea  
 B01535 24VDC Double Make & Break 240 ohms #R238 ..... 1.30 ea  
 B1-36 24VDC DPDT 210 ohms #R239 ..... 1.25 ea

## FERRITE RESISTORS

Over 200,000 in stock—all sizes—all wattages.

### H-F TIE POST



Low-Loss Bakelite Insulation, pictured actual size (4-40 Thread) \$7.50/C \$60.00/M

### S.S.WHITE DENTAL LAB RESISTORS

1K, 4K, 60K, 100K, 500K. All 1 watt \$10.00/C

9006 Jan Tubes—Bulk. \$.35 each

## LARGE STOCKS OF

- |                  |                     |              |
|------------------|---------------------|--------------|
| AN Connectors    | Controls            | Relays       |
| APC's            | Crystals            | Resistors    |
| Blinding Posts   | Filters             | Servo Xfms.  |
| Cable            | Fuses               | Shock-Mounts |
| Capacitors       | Hardware            | Sockets      |
| Ceramicons       | Iron Core Slugs     | Spaghetti    |
| Ceramics         | Knobs               | Switches     |
| Chokes           | Potentiometers      | Transformers |
| Circuit Breakers | (sine-cosine) Tubes |              |
| Cells            | Pulse Xfms.         | And Others   |

Write Us Your Needs for Immediate Quote PRICES FOB OUR PLANT Min. Order \$5.00

**Universal/general corp.**

324 Canal St. N. Y. C. WA Iker 5-9642

## TELEPHONE RELAYS

**CLARE** Telephone type 9500 ohm, 2 ma, High Speed Keying, 5 Make 1 Break #R104F ..... \$5.98 ea  
**AUTOMATIC** Telephone type, 1300 ohm, 9 ma, SPST, n. o. #R103 ..... 1.25 ea  
**KURMAN**, Telephone type, 3300 ohm, 7 ma, Make 3, Break 1, 5A contacts #R1243 ..... 2.95 ea

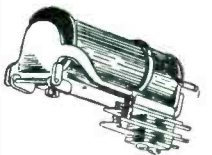

## SENSITIVE PLATE CIRCUIT

**DUMONT** 5000 ohm 5 ma SPST n.o. 10A Contacts #R230 ..... \$ .98 ea  
**POTTER & BRUMFIELD** SPS16 5000 ohm 9 ma Double break, 10A contacts ..... .38 ea  
 G.E. CR2791B109P36 10,000 ohm, 9 ma, double Make & Break 5A Contacts #R231 ..... .98 ea  
**WESTERN ELECTRIC** D168479, Mercury Contact, Hermetically sealed, 2 Coils: 700 & 3300 ohms. With coils in series makes at 6.6 ma, breaks at 5.2 ma, SPDT, High current capacity, High speed #R232 ..... 11.95 ea



## MISCELLANEOUS RELAYS

**WESTINGHOUSE** MN Overcurrent: Current Coll 100 to 400 ma DC, Reset Coll: 230 V AC or DC, also external push button reset. Glass enclosed; Individual Calibration #R234 ..... \$9.95 ea  
**WESTINGHOUSE** MN Same as R234 but 0.5 to 2A #R235 ..... 9.95 ea  
**STRUTHERS DUNN** CX1535A 12VDC SPST n.o. 240 ohms 20A contacts #R236 ..... 1.50 ea  
 G.E. CR2791B106J3 12VDC 3PDT 180 ohms 3A contacts #R237 ..... 1.25 ea  
 G.M. 12792-1 18-24VDC 3PDT 100 ohms 10A contacts #R240 ..... 1.75 ea  
**LEACH** 2069 (G.E. M7472260) 12-24VDC 3PDT 130 ohms 15A contacts #R241 ..... 1.50 ea  
**PRICE** 501A 12VDC DPDT 60 ohms #R242 ..... .95 ea  
**RBM** Voltage Regulator 6V SPDT Adjustable Contacts & Arm #R247 ..... 1.49 ea  
**AMPERITE** TIME DELAY 24N02 24V AC or DC SPST n.o. 5A Contacts 2 sec. delay at 24V; can operate from 110V with 1250 ohm resistor or larger for longer delay. #R316 ..... .98 ea

## PULSE XFMR'S

T151 is a 3 winding Pulse Input xfmr with hypersil core, 1000-ohm windings carefully balanced for operation in series with filament. Pulse modulation fed to low impedance winding. W. E. type KS9565 40 to 1000 to 1000 W, v 7.5 KV #T151 ..... \$3.25 ea  
**DONGAN** TR 1043-A461 Ratio 1:1 high power pulse modulation driver xfmr for final. Ea. winding approx. 8 ohms d-c; 200mh; 260T #30 wire #T152 ..... \$3.25 ea  
 W.E. (coreless type) A quasi-differentiating xfmr. Pri. when tuned with a .01 mfd resonates at 5630 cps. Split wound secondary terminates into 10000 ohms Army SC# 2C2270/T2 ..... \$2.25 ea  
 W.E. #KS9502 3 windings Blocking Osc. xfmr ..... \$1.75 ea  
 W.E. KS9504 1:1 ratio—high repetition rate ..... \$1.19 ea  
**FREED** #12524 2:1 ratio—high repetition rate ..... \$1.49 ea  
**HORIZONTAL** blocking osc. xfmr ..... .69 ea  
**VERTICAL** blocking osc. xfmr ..... .69 ea  
**UTAH**—X146-T1—2 winding ..... \$2.95

## HI CURRENT MICAS BAKELITE CASED

MFD	VV	EA.	MFD	VV	EA.
0.000051	3KV	\$.50	0.025	2.5KV	1.10
0.00005	3KV	.50	0.03	2KV	.75
0.0001	3KV	.50	0.035	1.5KV	.75
0.00055	5KV	1.10	0.05	1.5KV	.80
0.001	5KV	1.50	0.05	500	.70
0.002	3KV	.60	0.062	1KV	1.00
0.003	3KV	.60	0.12	500	1.25
0.01	2KV	.60	0.15	500	1.35
0.02	2KV	.80	0.25	250	1.25

Large Stock of Type 4 and 9 Transmitting Micacs

WIRE WRITE PHONE CABLE COME IN



STOCK UP NOW AT THESE LOW PRICES!

# ACORN

Serves Schools, Labs, Industrials  
Top Values—Same Day Service



### FILTER CHOKES

Hy.	@ Ma.	Ohms	D. C.	Mounting	Price
10	55	350	D. C.	Channel	\$ .69
10	60	400	D. C.	Hermetically Sealed	.69
15	70	420	D. C.	Hermetically Sealed	.79
10	75	200	D. C.	Channel	.79
10	85	200	D. C.	Channel	.89
20	100	350	D. C.	Hermetically Sealed	1.89
10	100	400	D. C.	Hermetically Sealed	1.79
15	110	400	D. C.	Upright	1.39
8	150	130	D. C.	Channel	1.19
10	150	200	D. C.	Cased Channel	1.39
3 1/2	150	65	D. C.	Channel	1.29
8	150	90	D. C.	Cased	1.39
10	200	60	D. C.	Upright	2.29
2.5	200	60	D. C.	Channel	1.29
15	250	65	D. C.	Upright	2.95
8	250	95	D. C.	Channel	2.39
12 1/2	500	95	D. C.	Cased	9.95

### STEP-DOWN TRANSFORMERS

Pri. 200-210-220-230-240 V.—50-60 cy.	
Sec. #1—117 V. @ 8 amp.	
#2—5 V. C. T. @ 10 amp.	
Open Frame Fed. Tel. & Tel.—	<b>\$10.95</b>
Pri. 200-210-220-230-240 V.—50-60 cy.	
Sec. #1—25 V. C. T. @ 10 amp.	
#2—25 V. C. T. @ 10 amp.	
#3—6.3 V. C. T. @ 5 amp.	
#4—6.3 V. C. T. @ 3 amp.	
Open Frame Fed. Tel. & Tel.—	<b>\$6.95</b>
Pri. 200-210-220-230-240 V.—50-60 cy.	
Sec. #1—115 V. @ 8 amp.	
Open Frame Fed. Tel. & Tel.—	<b>\$8.95</b>
<b>PLATE TRANSFORMER</b>	
Pri. 200-210-220-230-240 V.—50-60 cy.	
Sec. #1—556-0-56 @ 220 ma.—	
Open Frame Fed. Tel. & Tel.—	<b>\$5.95</b>

### POWER TRANSFORMERS

Pri. 115 V.—50-60 cy.		Pri. 115 V.—50-60 cy.	
Sec. #1—775 V. C. T. @ 175 ma.		Sec. #1—650 V. C. T. @ 150 ma.	
#2—6.3 V. @ 6 amp.		#2—6.3 V. @ 4.5 amp.	
#3—5 V. @ 3 amp.		#3—6.3 V. @ .3 amp.	
#4—5 V. @ 2 amp.		#4—5 V. @ 3 amp.	
Half Shell Mount—	<b>\$4.79</b>	Half Shell Mount—	<b>\$3.95</b>
Pri. 115 V.—50-60 cy.		Pri. 115 V.—50-60 cy.	
Sec. #1—700 V. @ 250 ma. C. T.		Sec. #1 800 V. C. T. @ 240 ma.	
#2—10 V. @ 6.3 @ 5 amp.		#2—6.3 V. @ 8 amp.	
tapped		#3—6.3 V. @ 2 amp.	
#3—5 V. @ 3 amp.		#4—5 V. @ 3 amp.	
Half Shell Mount—	<b>\$4.79</b>	Half Shell Mount—	<b>\$7.95</b>
Pri. 115 V.—50-60 cy.		Pri. 115 V.—50-60 cy.	
Sec. #1—600 V. C. T. @ 100 ma.		Sec. #1—750 V. C. T. @ 225 ma.	
#2—6.3 V. @ 3 amp.		#2—6.3 V. @ 8 amp.	
#3—5 V. @ 3 amp.		#3—6.3 V. @ 1.2 amp.	
Half Shell Mount—	<b>\$2.95</b>	#4—5 V. @ 3 amp.	
		RCA Half Shell Mount—	<b>\$6.95</b>
		Upright Mount—	<b>\$1.49</b>

### FILAMENT TRANSFORMERS

Pri. 105-115 V.—50-60 cy.	
Sec. #1—6.3 V. C. T. @ 5 amp.—	<b>\$2.79</b>
Thord. C. H. T. case	
Pri. 105-115-125 V.—50-60 cy.	
Sec. #1—6.3 V. @ 4.5 amp.	
#2—6.3 V. @ .6 amp.	
#3—6.3 V. @ .6 amp.	
Cased—	<b>\$2.95</b>
Pri. 115 V.—60 cy.	
Sec. #1—2.5 V. @ 10 amp.	
#2—2.5 V. @ 6 amp.	
10,000 V. insulation—	
Cased—	<b>\$4.95</b>
Pri. 115 V.—50-60 cy.	
Sec. #1—6.3 V. @ 1.2 amp.	
(Channel Mount—	<b>.89</b>
Pri. 200-210-220-230-240 V.—50-60 cy.	
Sec. #1—2.5 V. @ 20 amp. C. T.	
Insulated for 10 KV—	
Open Frame Fed. Tel. & Tel.—	<b>\$5.95</b>
Pri. 200-210-220-230-240 V.—50-60 cy.	
Sec. #1—6.3 V. C. T. @ 6 amp.	
Open Frame Fed. Tel. & Tel.—	<b>\$4.95</b>
Pri. 220-210-220-230-240 V.—50-60 cy.	
Sec. #1—5 V. @ 4 amp. C. T.	
Open Frame Fed. Tel. & Tel.—	<b>\$3.95</b>
Pri. 200-210-220-230-240 V.—50-60 cy.	
Sec. #1—9 V. @ 28 amp. C. T.—	
Open Frame Fed. Tel. & Tel.—	<b>\$10.95</b>

### LOW VOLTAGE

<b>STEP-DOWN TRANSFORMERS</b>	
Pri. 115 V.—50-60 cy.	
Sec. #1—15 V. @ 12 amp. G. E.—	<b>\$4.95</b>
Pri. 115 V.—50-60 cy.	
Sec. #1—10 V. @ 12 amp. G. E.—	<b>\$4.95</b>
Pri. 115 V.—50-60 cy.	
Sec. #1—16 V. @ 5 amp.—U. T. C.—	<b>\$2.79</b>
Pri. 110-147-220 V.	
Sec. #1—13 V. @ 8 amp.—U. T. C.—	<b>\$3.49</b>
Pri. 115 V.—50-60 cy.	
Sec. #1—24 V. @ 2 amp.—Ferranti—	<b>\$1.49</b>

### KENYON FILAMENT TRANSFORMER

Pri. 0-105-110-115 V.—50-60 cy.	
Sec. #1—11 V. @ 10 amp. C. T.	
#2—7 V. @ 1 amp. C. T.	
#3—7 V. @ 1 amp. C. T.	
Cased—	<b>\$4.95</b>

### OUTPUT TRANSFORMERS

6V6 Push Pull—8000 Ohm Pri.	
Plate to plate—12 W. output	
Univ. Sec. 4-8-15-250-500 ohm voice coil—	
Shielded U. M.—	<b>\$1.99</b>
6L6 Push Pull—6000 ohm. Pri.	
Plate to plate—25 W. output	
Univ. Sec. 4-8-15-250-500 ohm voice coil—	
Half Shell Mounting Shielded—	<b>\$2.95</b>

### VIBRATOR TRANSFORMER

Pri. 6 V.	
Sec. 600 V. C. T. @ 90 ma.—	
Upright Mount—	<b>\$1.99</b>

### 220 V. INPUT TRANSFORMERS

Pri. 200-210-220-230-240 V.—50-60 cy.	
Sec. #1—5 V. @ 14.5 amp. C. T.	
#2—5 V. @ 14.5 amp. C. T.	
Open Frame Fed. Tel. & Tel.—	<b>\$6.95</b>
Pri. 200-210-220-230-240 V.—50-60 cy.	
Sec. #1—367-0-367 V. @ 500 ma.	
Open Frame Fed. Tel. & Tel.—	<b>\$5.95</b>

### HEAVY DUTY POWER TRANSFORMER

Pri. 110-220 V.—50-60 cy.	
Sec. #1—820 V. C. T. @ 400 ma.	
#2—6.3 V. @ 3 amp.	
#3—6.9 V. @ 13.5 amp.	
#4—5 V. @ 3 amp.—	
Open Frame—(3 for \$21.)	<b>\$7.49</b>

### RCA HIGH FIDELITY OUTPUT TRANSFORMER

6L6 Push Pull 9000 ohm. Pri.	
Plate to Plate	
Sec. 8 ohms—25 W. output—	
Chicago Trans. Cased—	<b>\$4.95</b>

### 6V6 HIGH FIDELITY OUTPUT TRANSFORMER

Pri. 5000 ohms	
Sec. 4-8-15-ohm—Frequency response 60-10,000 Cy. = 1/2 D. B.—	
Hermetically Sealed—	<b>.98</b>

### 6L6 SINGLE OUTPUT TRANSFORMERS

Pri. 2500 ohms	
Sec. 6-8 ohms—	
Channel Mount—	<b>.98</b>

### 6V6 SINGLE OUTPUT TRANSFORMER

Pri. 5000 ohms	
Sec. 6-8 ohms—	
Channel Mount—	<b>.89</b>

## FOR IMMEDIATE DELIVERY

SPECIAL! 300 ohm TWIN LEAD TV LINE, per 100 ft. **\$3.89**

### DYNAMOTOR SALE!

RD77—Brand New	<b>\$8.95</b>
PE34—Used, excellent	<b>4.95</b>
PE73—Used, excellent	<b>4.95</b>

### CORDS

CD478—5 ft. long with Alligator Clips.	<b>19c pair</b>
CD307A with PL55 and JK26	<b>69c each</b>
PL68	<b>20c each</b>
PL55	<b>39c each</b>
PL54	<b>17c each</b>

### FILTER UNIT

This unit is an excellent buy for the parts alone. Some parts are worth more than we're asking for the whole unit.

- 1-40 MFD @ 450V
- 1-1600 MFD @ 12V
- 1-.5 MFD @ 400V
- 2-.5 MFD @ 50V
- 1-.01 MFD @ 400V
- 2-20 watt Resistors
- 2-Filter Chokes
- 2-RF Chokes
- 1DPST Toggle Switch
- Miscellaneous Hardware, wire,



BRAND NEW. ORIGINAL PACKING. 89c ea. (10 for \$7.50)

SLEEVING—various colors and sizes—3 ft. lengths. 10 lengths for **\$2.00**  
100 lengths for **\$20.00**

SOLDERING PASTE—8 oz. cans—U.S.N. Specification 51-FLB ..... **29c ea. (10 for \$2.50)**

### KIT SALE!

Kit of 50 assorted KNOBS	<b>\$1.19</b>
Kit of 25 TRIMMERS—single, dual and triple sections	<b>79c</b>
Kit of 10 assorted VOLUME CONTROLS	<b>\$2.79</b>
Kit of 100 assorted MICA and CERAMIC CONDENSERS	<b>4.75</b>
Kit of 100 assorted PAPER TUBULAR CONDENSERS—from 200 to 800 V.	<b>5.75</b>

### BATHTUB CONDENSERS

20 MFD @ 350 VDC	<b>14c each</b>
2 x .25 MFD @ 600 VDC	<b>\$12.50</b>
5-.5 MFD @ 100 VDC	<b>per hundred</b>
3 x 1 MFD @ 400 VDC	<b>per hundred</b>

### TERRIFIC TUBE SALE

Brand New—Standard Brands—Immediate Delivery	
3C24/24G	<b>59c</b>
102B	<b>39c</b>
10Y	<b>39c</b>
872A	<b>\$1.75 each</b>

THERMAL RELAY Type ER, 110 volts 30 amps. BRAND NEW..... **ONLY \$1.29 each**

### RCA MICAS

470 MMFD, 1200 MMFD, 1500 MMFD	<b>.6c ea. (\$50.00 per thousand)</b>
--------------------------------	---------------------------------------

### TRANSMITTING MICAS

.0001 @ 5000 V., .00025 @ 5000 V	
F2L Type	<b>59c each</b>

### RESISTORS

5 ohm—10 watt	<b>14c</b>
85 ohm—10 watt	<b>14c</b>
2500 ohm—25 watt	<b>17c</b>
2500 ohm—33 watt	<b>20c</b>
250 ohm—50 watt, lamp base	<b>24c</b>
105 ohm—100 watt, 4 taps	<b>48c</b>
50 ohm Muter Resistor	<b>.8c ea. (\$6.00 per hundred)</b>

HEAVY DUTY LINE CORD with molded plugs, 3 ft. long **.9c each**  
6 ft. RUBBER LINE CORDS with molded rubber plugs **\$15.75 per 100 cords**

3 GANG TRF VARIABLE CONDENSER—	<b>.89c ea. (10 for \$7.25)</b>
365 per section with push buttons	
2 GANG FM-AM VARIABLE	<b>.89c ea. (10 for \$7.25)</b>

MINIMUM ORDER—\$2.00. Send 25% deposit with order, balance C.O.D. Shipped F.O.B., N.Y.C. (N.Y.C. residents add 2% sales tax.)

## RED ARROW SALES CO.

Dept. T, 63 East Broadway, N. Y. 2, N. Y.  
Phone—Cortlandt 7-5425

## FOR SALE

Bausch & Lomb Binocular Research Microscope Optics. Mid-40's vintage, uncoated. Some slightly used, most unused. Five apochromat objectives—10x Dry, 47.5x Dry Adjustable, 67x Dry, 81x Oil, 78x Glycerine. Pair 5x compensating eyepieces. Three condensers—achromat, cardioid & paraboloid on slide mounts. Also miscellaneous incidentals—\$590.

### CALL

Ted Powell, Great Neck 4-4129  
(Long Island) after 6:30 P.M.

ALL MERCHANDISE SUBJECT TO PRIOR SALE

Phone Worth 4-3270

ACORN ELECTRONICS CORP.  
76 Vesey St. Dept. E3 N. Y. 7, N. Y.

Terms: 20% cash with order, balance C.O.D. if rated, terms 15% net 10 days. All prices F.O.B. our warehouse in N.Y.C. Minimum order \$5. NOTE: Due to conditions beyond our control, prices are subject to change.

# Desirable Select Surplus ELECTRONIC EQUIPMENT

- BC-375-E Aircraft transmitters complete, new, with all turning units, 24 volt dynamotor, tubes, plugs, etc. Price  
\$125.00
- BC-191 same as above for 12 volt operation \$125.00
- TDE Navy model radio transmitters with 230 volts, D.C. power supply, complete with tubes, ready for operation. New \$675.00
- SCR-522 Aircraft radio transmitters-receivers complete with dynamotor, control box, plugs, jackbox, microphone adapter, microphone, headset, extension cord. Newly overhauled, inspected and tested \$130.00
- SF Ships' radar units complete with all components \$500.00
- TCS, Collins type Navy and mobile type transmitters-receivers complete with remote control, antenna coil, cables, key, microphone, for 110 volt A.C. operation including set of parts. New in original cases \$1,275.00
- TCS Collins type, transmitters-receivers, same as above but without spare parts. Refinished, checked-out and guaranteed for operation on 12 or 24 volts D.C. \$575.00
- ET-8023-D1 Radiomarine Corporation telegraph transmitters \$375.00
- BC-348 Receivers, unconverted 24 volt operation \$150.00
- MN-26 Bendix radio compass receivers \$45.00
- BC-221 A.K. Frequency meters with modulation \$125.00
- BC-221 Frequency meters without modulation \$100.00
- LM-15 Frequency meters (Navy version of BC-221 A.K.) with modulation and A.C. power supply \$150.00
- I-100A Test sets for SCR-269 \$750.00
- IE-19A Test set for SCR-522 \$350.00
- ARP-5 high-frequency oscillators Price on Application
- JWG-458 Gasoline-engine driven electric generating plants, 5000 watts, Onan, 100-120 or 220-240 volts, rebuilt-factory reconditioned \$590.00
- Telephone or power line insulators, glass Hemingray No. 40, heavy duty .10
- W-118 B Army field telephone wire \$7.50
- RC-58-B Army Tape Facsimile transmitters-receivers \$250.00
- Link radio transmitters-receivers 1498 including remote control and antenna reconditioned. Price on Application
- Link-50 UFS receivers, transmitters including remote control and antenna. New Price on Application

ALL ITEMS ARE OFFERED F.O.B. OUR WAREHOUSE, AND ARE SUBJECT TO PRIOR SALE. ALL ITEMS ARE NEW, UNUSED SURPLUS UNLESS OTHERWISE INDICATED.

**FRENCH-VAN BREEMS, Inc.**  
405 Lexington Avenue New York 17, N. Y.

## BRAND NEW

U. S. GOV'T. SURPLUS

## GUARANTEED

### POWER RHEOSTATS



Ohms	watt ea.	Ohms	watt ea.
.5	25 1.24	150	50 2.10
.5	50 2.34	175	25 1.87
.5	150 4.45	185	25 1.24
.5	250 2.34	200	25 1.24
1	25 1.24	200	100 3.29
2	100 3.51	225	50 2.10
2	225 9.60	250	25 1.86
2	300 6.32	250	50 1.49
2	300 3.51	300	50 2.11
3	225 9.60	300	100 3.29
4	225 9.60	350	25 1.24
5	25 1.24	350	100 3.28
5	100 3.51	370	25 1.24
6	25 1.86	378	150 4.95
6	25 2.10	400	25 1.24
6	75 4.80	400	75 4.80
7	25 1.24	500	25 1.24
8	50 1.49	500	75 4.80
10	25 1.86	500	50 1.49
10	100 3.28	500	100 3.29
12	25 1.86	585	150 3.51
12	50 1.49	750	25 1.86
15	25 1.24	750	150 4.45
15	75 4.80	1000	25 1.24
15	100 3.29	1000	150 4.45
22	50 2.10	1200	225 9.60
25	25 1.86	1250	50 2.22
25	100 3.29	1250	50 2.22
25	150 4.21	1500	25 1.11
32	300 6.42	1500	50 2.22
50	25 1.24	1800	150 4.68
50	50 1.49	2000	25 2.10
60	750 21.30	2000	50 1.49
60	25 1.24	2500	25 2.11
75	25 1.24	2500	50 2.22
75	75 4.80	2500	100 3.51
75	100 3.29	3000	25 1.24
75	150 4.21	3000	100 3.51
80	50 2.10	5000	25 2.22
80	500 9.13	5000	50 2.34
100	25 1.24	7500	50 2.34
100	50 1.49	7500	100 3.98
100	100 3.29	10000	50 2.34
100	225 9.60	10000	100 4.21
125	25 1.86	15000	25 2.67
125	50 1.49	20000	150 6.32

Specify whether shaft required is for knob or screwdriver adjust.

### SELECTOR SWITCHES

Pole Pos.	Deck	Type	Each
1	11	1 bak-n/shotg.	.60
1	21	3 bak-n/shotg.	.89
2	5	2 cer-shotg.	.50
2	11	2 bak-n/shotg.	.60
3	4	1 bak-n/shotg.	.53
3	3	2 Cer-n/shotg.	.98
10	11	6 bak-n/shotg.	1.95
16	5	5 cer-shotg.	2.25
16	2	4 bak-n/shotg.	1.35

(many other types in stock)

### "AN" CONNECTORS



LARGE VARIETY AVAILABLE AT GREAT SAVINGS

Send your specs and let us quote

### BIRTCHEr TUBE CLAMPS

#926-A	#926-B22
#926-A1	#926-C
#926-A11	#926-C1
#926-B	#926-C2
#926-B1	#926-C10
#926-B7	#926-C24

### MICROSWITCHES

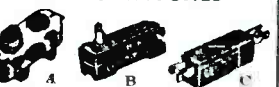

- A-YZ-RS13 SPST "S" plunger, metal housing norm. op. .49
  - B-ZB-RS10 SPDT type "S" plunger, 2-contacts; one op and one cl. .49
  - #WZ-FLS (not illus.) SPST leaf actuator, norm. cl. .49
  - #R-RL2T (not illus.) SPST 10a 125 vac roller plunger, norm. closed. .49
  - C-G-E SWITCH TYPE 10a/115volts AC .49
  - #CR1070-C103A3 SPST closed. .49
  - #CR1070-C103E3 SPST open. .49
  - #CR1070-C103R3 SPST closed. .49
  - #CR1070-C123C3 DPST op/cl. .49
- (Many other types in stock)

### OIL CONDENSERS



Mfd	VDCW
1	3000
1	6000
1	20 000
2	3000
2	25 3000
5	1500
1	600
1	2000
2	400
2	600
2	1000
4	900
6	400
6	600
10	600
14	600
15	600
15	1000
2 x 1	7000
2 x 5	9000

### BATHUBS



mfd	vdcw
.033	400
.05	200
.05	400
.05	600
.05	400
.1	600
.1	1000
.15	600
.25	200
.25	400
.35	400
.5	400
.5	600
.5	1000
1	200
1	400
2	400
2	600
4	50
5	500
25	75
40	25
50	25
200	12
300	6
.05-.05	800
.05-.05	1500
1-1	400
1-1	600
2-2	600
25-.25	600
25-.25	800
200-200	600
3 x .05	600
3 x 1	400
3 x 1	600
3 x .25	600
3 x 1.0	100

### "UG" Connectors

UG-12/U	\$1.10
UG-13/U	1.49
UG-18/U	1.15
UG-19/U	1.15
UG-21/U	1.18
UG-22/U	1.05
UG-24/U	1.10
UG-25/U	1.15
UG-27/U	1.75
UG-57/U	.89
UG-58/U	.63
UG-123/U	.40

### SHOCKMOUNTS

100P-1	1 lb. .15
100P-2	2 lb. .15
100PR-2	2 lb. .15
100P-3	3 lb. .15
100P-6	6 lb. .20
150P-4	4 lb. .20
150PH-3	8 lb. .45
150PH-15	15 lb. .49
156P-6	6 lb. .35
200PD-15	15 lb. .59
200PHN-35	35 lb. .75
204P-112	112 lb. .98

### TERMINAL BOARDS

5 terminal	.98
8 terminal	1.67
12 terminal	2.49

### TYPE "J" POTENTIOMETERS

TYPE "J" \$1.50		TYPE "JJ" \$2.50	
ohms	ohms	ohms	ohms
50*	2500*	100 K*	500-500*
200*	4000*	100 K*	500-600*
300*	5000*	125 K*	1500-1500*
400*	15 K*	200 K*	2000-2000*
500*	20 K*	250 K*	2000-50 K*
600*	25 K*	250 K*	2200-24 K*
750*	25 K*	500K*	20 K-2000*
1000*	30 K*	1meg*	25 K-10 K*
1500*	50 K*	1meg*	35 K-5000*
2000*	80 K*	2meg*	50 K-50 K*
			5meg-5meg†

### TYPE "JJJ" \$4.95

ohms		ohms	
20K-200K-20K†		750K-750K-750K†	
45K-27K-2500†		800K-800K-800K†	
700K-700K-700K†		1meg-1meg-1meg†	

\* 1/8" screwdriver slotted shaft.  
† Knob type shaft.

### TRANSMITTING MICAS

Type 9		Type 4	
mfd	vdcw	type	ea.
.00001	600	4	18.00162
.00003	600	4	18.002
.00005	600	4	18.002
.00005	2500	9	31.0022
.0001	600	4	18.0025
.0001	2500	9	31.003
.000152	600	4	18.0039
.0002	600	4	18.005
.00025	600	4	18.005
.0005	600	4	18.005
.0051	2500	4	43.0062
.0007	600	4	18.01
.0008	600	4	18.01
.0009	600	4	18.01
.001	600	4	18.0142
.001	1200	4	31.02
.0013	600	4	31.02
.0013	600	4	18.027
.0015	600	4	18.043

(Many other types in stock)

### "UHF" CONNECTORS



Cat. No.	Army No.
83-1AC	M-359
83-1AP	PL-271
83-1F	PL-274
83-1R	SO-239
83-1SPN	PL-269A
83-22R	SO-264

### CONNECTORS

S-302-AB	.13	2-140-Y	.18
S-304-CCT	.25	6-140-Y	.23
P-306-AB	.18	9-140	.33
P-306-CCT-L	.33	10-140-Y	.34
S-306-FHT	.24	10-140-3/4W	.53
S-308-AB	.21	10-140-3/4W	.53
S-312-AB	.24	10-240	.38
P-312-CCT-L	.42	13-140	.48
P-315-FHT	.40	4-141-W	.30
P-315-EB	.30	4-141-3/4W	.30
P-315-CCE	.40	5-141	.26
S-315-AB	.36	7-141-Y	.49
S-318-AB	.43	11-141-Y	.76
P-324-FHT	.73	12-141-Y	.82
P-324-EB	.58	12-141-Y	.82
S-330-AB	.84	13-141	.62
S-404-AB	.33	13-141-Y	.89
P-406-AB	.58	15-141-Y	1.02
S-406-CCT	.58	2-142-Y	.20
S-408-CCT	.69	4-142-Y	.36
P-2412-SB	.53	8-142	.48
S-502-CE	.61	10-142-3/4W	.85
S-502-D	1.10	11-142	.65
P-508-CE	.97	3-150	.53
P-508-CE	2.55	4-150-Y	.83
P-510-CE	3.04	4-151	1.30
S-510-SB	2.64	5-151	1.60
P-512-CE	3.52	4-152	1.89

Many other types in stock

### MALLORY PUSH SWITCH

#2001	S.P. make cont., non-L	.45
#2003	S.P.D.T., non-lock	.48
#2003L	S.P.D.T., lock	.48
#2004	D.P., make 2, non-L	.55
#2004L	D.P., make 2, lock	.55
#2006	D.P.D.T., non-lock	.65

HUNDREDS OF OTHER ITEMS AVAILABLE  
Open a/c to Rated Concerns. Prices net FOB our whse NYC and subject to change without notice

**ALEXANDER MOGULL CO., INC.**  
161 Washington St., N. Y. 6, N. Y. WORTH 4-0865



**AN CONNECTORS**  
FAST SERVICE - LOW COST

REFER to Page 279 Jan. Electronics for COMPLETE LISTING

**CONNECTORS**

PJ-055B-New high temperature version of old PL55 .....\$60  
 XL-3-11, fine three circuit, 15A..... .45  
 Solderless RG59U connectors, C-51..... .48  
 Chassis mtg jack C-51, C-61..... .51  
 Junction fit two C-51, C-61..... .60  
 Winchester 5KV on three circuits and 500 volts on each of twelve circuits, #201 & #202, pairs with shells, regularly \$26 without shells, our price ONLY \$9.50  
 COAXIAL: PL259 \$.45, PL258 \$.70, PL274 \$1.20, UG95U, UG10U, UG12U, UG13U, UG21U, UG22U, UG25U, UG27U, UG58U, UG59U, UG59U, J-201, UG342U, UG203, CQA 49547, 8880078-501 (VVE type jack)..... ONLY \$6.60  
 SPECIAL-M359, 83-1AP, 49192.....\$.15  
 Lundquist 8 contact, 49170 & 49043 pr.....\$.25  
 USECO tiny pairs of plugs & jacks for swaging in Bake. board, #1690, pr.....\$.17  
 Jones P302CCT \$.27, P304AB \$.16, P306AB \$.20, P308CCT \$.38, P310FIT \$.35, P312AB \$.29, P315AB \$.38, P318AB \$.48, P321CCT \$.86, P324EB \$.73, P324CCT \$1.01, P330CCT \$1.33, P330SB \$1.27, S302AB \$.13, S303CCT \$.29, S304AB \$.17, S306AB \$.21, S308AB \$.26, S310AB \$.31, S310CCT \$.47, S310FIT \$.40, S312AB \$.36, S315AB \$.45, S318CCT \$.79, S321AB \$.67, S324AB \$.76, S330SB \$1.33, P406CCT \$.64, P408AB \$.48, P410AB \$.54, P412SB \$.83, S404CCT \$.62, S408CCT \$.86, S410AB \$.70, S410CCT \$.99, S412AB \$.79.

**25 WATT WIRE WOUND POTENTIOMETERS**

Refer to Jan. Electronics for description. 2, 3-3, 15, 20, 25, 30, 50, 75, 100, 350, 500, 800 ohm- reg. \$3.12. SALE PRICE.....\$1.04  
 1K, 3K, 5K.....\$1.20, 20K.....\$1.40

**PRECISION POTENTIOMETERS**

Leading Manufacture, Wire Wound 10, 12 ohm #301.....\$1.20  
 1.5K ct, 2K, 5K, 20K-8 watt.....1.70  
 100K 25 watt.....6.50

**CTS Wirewound POTENTIOMETER**

These excellent controls were made to sell for \$2 each. They are the finest ww potentiometers made in the two and four watt size. The four watt has a 1-9/16" dia. x 1 1/16" metal body. The two watt has a 1-1/4" x 9/16" bakelite body. Both use DUAL wipers for extra quiet action. SPECIAL PRICE.....\$4.50  
 Four watt: 6, 30, 50, 100, 750, 1K, 1.5K, 2K, 3K, 4K, 7.5K, 10K, 15K, 20K ohm.  
 Two watt: 20, 75, 200, 255, 300, 350, 500, 750, 1000, 2K, 5K, 10K ohm  
 Four Watt Tt also line control with mica filled bakelite body: 2K, 5K, 10K, 20K, (Over 2000 each 5K in stock).....\$.45

J Composition Pots: 75, 200, 1K, 1.5K, 2K, 2.5K, 5K, 10K, 15K, 25K, 30K, 50K, 100K, 250K, 300K, 1 Meg, 2 Meg.....\$1.25  
 GLASS to METAL HEADER, eight different color seals in 1x1x5/16" metal cap. P/size #267535 our stock # 345, 1400 in stock.....\$.22



Special High Voltage Glass to Metal Seal for 3/16" hole 1 1/4" overall, #356.....\$.10  
 Reg. \$.25

TURRET SOCKETS & PLUG-IN UNITS, complete stocks on hand for immediate service.

TURRET LUGS, complete stocks including new miniature molded melamine tie point only 1/4" diameter by 3/8" high w 2-56 thread, #1426.....\$.18

**No "LION" About it**  
**Get Your MARCH Orders**  
**In On the "LAMB"**



**EAGLE ADJUSTABLE TIME DELAY RELAY.** 110 volt 60 cy with double throw Micro Switch. Can be set from 1 1/2 to 58 minutes. Includes attractive 3 1/4 x 4 1/2 x 2 3/4 black cover. 265 pieces in stock. Made to sell for \$26. SALE PRICE.....\$6.95

DELAY LINE 15-T4-.91-400-50P, Sprague #S92-5245, H623, 1x5x7inch oil filled with 3 1/2 inch insulators. 0.91 Microsecond, 15KV.....\$9.90

PULSE FORMING LINE, Millen flexible type, 23 1/2 inches long, form 2 microsecond pulses, Zo-1000 ohm. our #388.....\$3.75

**PULSE TRANSFORMERS**

A117012, Bendix, 1 7/8 x 1 7/16 x 1 13/16" can, nine terminals, Hypersil core.....\$1.50  
 C12A-1318, Jefferson, 50 millihenry & 10 millihenry, 2 3/4 x 3 x 3 3/4.....\$1.95  
 D161310, WE, frequency response 50K to 4 Mc. Video input, 120 to 2350 ohm, Perm. core, .150 K2468B, GE Magnetron pulsing, Bifilar, 250KVA peak power at 1/4 microsecond pulse, 1000/1 duty cycle, 3.85KV into 50 ohm pulse cable socket gives 17.3 KV to built-in Mag. socket. Only 31 in stock. Cost \$223. SALE PRICE.....\$18.00  
 L406825, Wenco, Pulse Inversion, 25 turns ea winding 200 volts to 200 volts at 3 ampere, 0.93 ohms DC, 3 1/4" dia. x 4 1/2" high.....\$1.50

CONVERTER, Electronic Labs Model 1485, 26 VDC input, 115 volts, 60 cy., 50 watts output, complete with NSB1341 vibrator.....\$14.95

POWER SUPPLY, PE204A, Radlart to operate from 12 volts DC to supply plate & screen & DC filament volts to telephone repeater EE99 & TY14. Sealed in original packing cases with spare vibrator, cable, schematic, etc.....\$9.95

ANTENNA AN80-A, SC ZA-275 w MC299 connector for BC645, 418 in stock.....\$.98

RELAY, 24 Volt, Tiny CP Clare operates on 86 milliamperes, 4 pole DT & make-break, 1 x 1 1/4 x 1 7/16 overall, 1000 in stock.....\$.90

RELAY, 24 Volt, Struthers Dunn 10XB102, mkd. 24 VDC, but has shaded pole, good for 60 cycle operation, DPDT, 7 amp contact.....\$.90



CHOKE, Conservatively rated 165 MA, 5 Henries, 160 ohm dc, 2 Inch High, 3 3/4" Mtg. Ctr. Worth \$3.  
 SALE PRICE

**89 cents**

#1A-158, 2000 pieces in stock.



Widely Known for Fair Dealing and Good Service

**HAROLD H. POWELL**

632 Arch Street Philadelphia 6, Pa.  
 Market 7-5650

**CERAMIC CAPACITORS**

FEED THRU

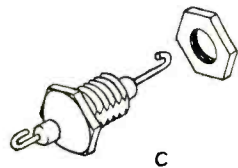

Type A—300 mmf—100 for \$20.00  
 Type B—300 mmf—100 for \$20.00  
 Type C— 55 mmf—100 for \$10.00

**ELECTRO IMPULSE LABORATORY**

62 White St. Red Bank, N. J.

**CONDENSERS OUR SPECIALTY**  
OIL FILLED TYPES

All Values and Voltage Ratings  
 We Invite Your Inquiries

TECHNICAL RADIO PARTS CO.  
 557 McDonald Ave., Brooklyn 18, N. Y.

**"AN" "K"**

3108 WK  
 3106 GK  
 3102 SK  
 3100 NK

**Connectors**

FOR IMMEDIATE DELIVERY

What Types Do You REQUIRE?

WRITE—WIRE—PHONE

**WILGREEN**

74 Cortlandt St. N. Y. 7, N. Y.

BA-7-4862

**TELEPHONE RELAYS**

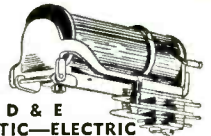

CLARE, TYPES C, D & E  
 COOKE, AUTOMATIC—ELECTRIC  
 ALL TYPES of COILS and PILE-UPS  
 Send Us Your Specifications For Our Quote

MONTHLY SPECIALS

CLARE TYPE C (or equivalent) RELAYS

1) 6500 ohm coil, SPST, N.O. 3ma. \$1.65 ea.  
 2) 3300 ohm coil, SPDT.....\$1.65 ea.  
 3) 1300 ohm coil, 3 make 1 break \$1.25 ea.

CLARE TYPE G (or equivalent) RELAYS

500 ohm coil DPDT......95 ea.  
 WRITE WIRE PHONE

CHASE ELECTRONIC SUPPLY CO.  
 105-07 225th St., Queens Village, N. Y.  
 HOllis 4-5033

**SNOOPERSCOPIES**

Navy surplus units. All are in perfect operating condition. Sales will be made for experimental, research or production work only. Write for prices and details.

**COLONIAL PULSE GENERATOR**

Model 700-A. Generates variable width and PRF pulses from 4 to 120 microseconds, metered output to 20 volts, unmetered to 100 volts. Built in sweep circuits, 115 volt 60 cycle. LIKE NEW 400 dollars

**KILOVOLT METERS—PROBES**

Several models in stock to 100 KV. Very low current drain. 100 KV probes in stock.

**PRECISE MEASUREMENTS COMPANY**

942 Kings Highway, Brooklyn 23, N. Y.

MAIL ORDER ADDRESS  
1060-2 N. ALLEN AVE.  
PASADENA 7, CALIF.  
SYCAMORE 4-7156  
RYAN 1-8271

# PHOTOCON SALES

## MARCH SPECIALS

RETAIL SALES STORE  
1240 EAST COLORADO ST.  
PASADENA 1, CALIF.  
SYCAMORE 6-7217

Write for our Latest Sales Bulletins

### TRANSMITTERS — RECEIVERS

We have BC-348 24V. DC. Aircraft Receivers, ART-13 and ATC Transmitters. Please send us your requirements.

SCR-522 Transmitter-Receiver Sets—Complete with PE-94 dynamotor, BC-602 Control Box, BC-631 Jack Box, AN-104A Antenna, plugs, racks, and mounts, New accessories  
**EXCELLENT 70.00**

Mine Detector SCR625 for locating metal, underground pipes, prospecting, etc. With Manuals  
**GOOD USED 39.50**  
**NEW 69.50**

APPR4 Receiver with TN-17, Brand New—Write for prices.  
BC-640 Transmitter—50 watt rack type—Same frequency as SCR-522...**GOOD CONDITION 695.00**  
RA-10 Bendix Compass Receivers...**LIKE NEW 24.50**  
RU-19 Receivers—Complete...**NEW 27.50**  
APR5AX Receiver...**LIKE NEW 325.00**  
BC-464 Target Receiver—5 channel remote, sensitive relays, battery case, antenna—69-73mc...**BRAND NEW 14.95**  
RS/ARN7 Compass—Complete Installation  
**EXCELLENT 95.00**

Transformer—High voltage, General Electric No. 6949101, Single Phase Plate 15,550 volts—5.2KVA, Input 115 volts 50/60 cycles, Filament—5 volts—0.65KVA, Input 100 volts 50/60 cycles...**EXCELLENT CONDITION 59.50**  
Variac—General Radio Type 50A 115V, 60 cycles—5KVA, Like New...**\$95.00; Good Used 80.00**  
ATD Transmitter 540-9050KC, 50 watt CW and phone. Complete with tubes, coils dynamotor  
**NEW 95.00**

BC-375 Transmitters, Complete with tuning units, plugs, dynamotor, mountings, microphones. Export packed...**LIKE NEW 89.50**

### TUBES IN STOCK Clean Bulk and Boxed

We have thousands of tubes—Send Us Your Requirements.

Delco Motor—27 volts 2.4 amps—3600 RPM Constant Speed Model A-7155 Governor Type Shunt...**NEW 5.95**  
RA-62 Rectifier Power Supply for SCR-522 115V, A.C. ...**LIKE NEW 120.00**  
PE-73 Dynamotor Power Supply for BC-375 1000V, D.C. Output...**EXCELLENT 5.95**

### HIGH VOLTAGE OIL CAPACITORS

25 mfd. 2000 volt Photoflash...**\$10.00**  
.65 mfd. 12,500 WVDC...**12.95**  
.25 mfd. 20,000 WVDC...**9.95**  
1. mfd. 6000 WVDC...**5.95**  
1. mfd. 20,000 WVDC...**29.50**  
We have hundreds of new oil and high voltage mica capacitors. Send us your requirements.

PE-206 Inverter 800 cycle—Will power APN4 and APN9 24V. D.C. Input...**USED 3.75**  
**NEW 6.95**

PE-94 Dynamotor Power Supply for SCR-522  
**USED \$3.50**  
**NEW 5.50**

Onan Motor Generator Set MG G-1 Generates 115V, A.C. 5.3 amps, 26 D.C. 100 watts, 480 cycles 3.8 amps., Motor 115-230V, 60 cycles, Single phase, 2450 RPM 10.5 amps...**NEW 170.00**

Selsyn Transmitter—Pioneer Inst.—AY 14 excellent for indicator...**EXCELLENT 3.50**  
Low Inertia Motor Type No. 10047-2A 24 volt—Pioneer Inst. Precision type...**2.50**

BC-705 Interphone Amplifier, tubes, battery operated...**NEW 3.95**  
PL-8 Range Filters...**NEW 1.95**

TELETYPE PAPER—8 1/4" wide x 3 1/4" dia. rolls—White—single...**.50**

Sound Powered Head and Chest Sets—Manufactured by U. S. Instrument Co.  
**EXCELLENT USED. \$4.95 Each; Per Pair 8.50**  
**FAIR USED. 2.95 Each; Per Pair 5.00**  
CD-605 Cords—6 ft. tinsel rubber covered **NEW .18**  
Matching Transformer for HS-30 Headset **NEW .40**

HS-23 HI Imp Headset, ear cushions **NEW 2.45**

APN-1 Altimeter Indicator, basic movement 0-1 ma., 5 ma. shunt, 270° dial. An excellent basic movement for constructing meters.  
General Electric...**NEW 1.95**  
Crystal and Coil Sets for Handy-Talkie—3885, 4280, 4840, 5327.5, 5437.5, 5500 K.C.—2 crystals and 2 coils per set...**SET 1.95**

### PLUGS

PLQ-171, PL-172, PLQ-60, PLQ-63, PL-147, PL-148, PL-151, PL-152, PL-153, PL-154, PL-156, PLQ-103. Plugs for ARC-1, ARC-3, ARC-5, BC-375, SCR-522, BC-348, GP-6, GP-7, LM Frequency Meters and many others.

BC-1060 Oscillograph—Same as Dumont #224  
**LIKE NEW 175.00**  
TS-224 Dumont Oscillograph...**GOOD USED 170.00**  
Megger—50 megs. 500 volts...**EXCELLENT 75.00**  
Insulation Tester—Superior Model 610B, 200 megohms, Complete...**NEW 49.00**  
I-100A Test Set for ARN-7 and 269 Compass  
**LIKE NEW 595.00**  
II-19A Test Set for SCR-522—Complete with manual, original factory packing...**NEW 325.00**  
LM Frequency Meter with calibration books, crystal, tubes...**EXCELLENT 79.50**  
BC-221 Frequency Meters, Complete with calibration books, crystal, tubes...**EXCELLENT 79.50**  
TS-16 APN Test Set...**GOOD CONDITION 47.50**  
Standard Signal Generator—Measurements Corp. Model 78-B 15-25MC. 190-230MC.  
**LIKE NEW 100.00**  
Tube Checker—Model CHI-60067—115V, 60 cycles...**EXCELLENT 49.50**  
Sweep Generator—Model M for AN/APG13. Made by M.I.T. Radiation Laboratory  
**EXCELLENT 79.50**  
Weston Model 506 Voltmeter 0-20,000 volts with 4 Model 505 multipliers...**NEW 39.50**  
LU-1 Radar Test Set...**NEW 79.50**  
Insulation Tester—Interstate Mfg. Co. Model 1000...**EXCELLENT 80.00**  
BC-906 Frequency Meter...**EXCELLENT 17.50**

Weston Tachometer Generator Model 724 Type C...**GOOD USED 12.95**  
Weston Electrical Tachometer Model 545 for use with 724 Generator 0-2000 RPM Ratio 2:1...**NEW 14.50**

Output Meter CWI 60ABJ, 115V, 60 cycles, P. O. ASI Radar with manual...**LIKE NEW 49.50**  
Engine Cylinder Thermometer Tester—Mark II, Wheelco Inst. Co. Iron-Constantan, Copper-Constantan 0-350°C...**EXCELLENT 75.00**  
Engine Cylinder Thermometer Tester—Wheelco Inst. Co. Iron-Constantan, Copper Constantan, Chromel-Alumel 0-1400°C  
**EXCELLENT 95.00**  
TS-24A/AR12 Test Oscillator...**EXCELLENT 29.50**  
We will buy new or clean used ARC-1, ARC-3, ART-13, BC-348 original condition or converted to 115V, A.C. BC-312, BC-342, Test Equipment, etc. All letters will be answered promptly. Please list equipment, condition, and lowest price.  
**TERMS: Prices f.o.b. Pasadena, Cal. 25% on all C.O.D. orders. Californians add 3% Sales Tax.**

# "AN"

Ferrules **CONNECTORS** Clamps  
etc. **3100** 3057-3  
3050 **3101** 3057-4  
3051 **3102** 3057-6  
3052 **3106** 3057-8  
3053 **3108** 3057-10  
3054 3057-12  
3055 3057-16  
3056 3057-20  
3060 3057-24  
3061 **ALL TYPES OF** 3057-28  
3062 **"AN" HARDWARE** 3057-32  
3063 **Phone or Write** 3057-40  
3064 **Immediate Delivery** 97-3057  
3066 10-6  
3068

**THE STEVENS AIRCRAFT CORP.**  
31 E. RUNYON ST.  
NEWARK 8, N. J. **Bigelow 8-5619**



## WE HAVE LARGE QUANTITIES OF RADIO TUBES

TYPE	TYPE	TYPE	TYPE	TYPE	TYPE	TYPE	TYPE
1A5GT	2E22	6AQ5	6C6	6SG7	12A6	OZ4A	807
1G6GT	2X2	6B8	6H6	6SH7	12SG7	VR150/30	808
1LD5	3AP1	6B8G	6J5	6SK7	12SH7	42	813
1LN5	6AB7	6BE6	6J5GT	6SK7GT	12SK7	357A	830B
1R5	6AC7	6C21	6K6GT	6SS7	12SR7	803	866A
1S4	6AK6	6C4	6K7GT	7Q7	35Z4GT	805	9005
1T4	6AL5	6C5GT	6N7GT				

Prices On Request

All tubes are brand new standard brands. This offer subject to change without notice and prior sale. Terms: 25% deposit with order, balance C.O.D. \$25.00 minimum order.

**MANUFACTURERS: Interested in EXPORT? CONTACT MICHEL LEVIT**

## METROPOLITAN OVERSEAS SUPPLY CORPORATION

MANUFACTURERS AND DISTRIBUTORS OF ELECTRONIC PRODUCTS

1133 BROADWAY, NEW YORK 10, N. Y. CHELSEA 3-1105

## ELECTRONIC SURPLUS WANTED

**SURPLUS ELECTRONIC**  
Materiel of All Types  
**FOR SALE**

**GOULD GREEN**  
252 Greenwich St. N. Y. C. 7  
PHONE—WORTH 4-8044

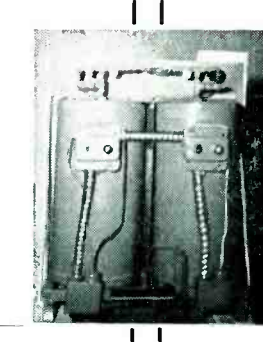

## The "KELLOGG DEHYDRATOR"

An all purpose self-reactivating dehydrating unit. To be used for removing moisture from gases. Numerous applications in the fields of Physics, Electronics and Chemistry. Dual insulated tanks with thermostatically controlled heating elements. Complete with 20 lbs. of Silica gel, heating elements, shut-off and safety valves.

**\$62.50**  
F.O.B., N. Y.  
**INTERSTATE Appliance Co., Inc.**  
Dept. KD, 600 Broadway, NEW YORK 12, N. Y.



# SELENIUM RECTIFIERS and ASSOCIATED COMPONENTS

## SINGLE PHASE Full Wave Bridge

Input: 0-18 VAC	Output: 0-12 VDC	Type No.	Current	Price
B1-250	250 Ma.			\$ .98
B1-1	1.0 Amp.			2.49
B1-1X5	1.5 Amp.			2.95
B1-3X5	3.5 Amp.			4.50
B1-5	5.0 Amp.			5.95
B1-10	10.0 Amp.			9.95
B1-20	20.0 Amp.			15.95
B1-30	30.0 Amp.			24.95
B1-40	40.0 Amp.			27.95
B1-50	50.0 Amp.			32.95

Input: 0-36 VAC	Output: 0-26 VDC	Type No.	Current	Price
B2-150	150 Ma.			\$ .98
B2-250	250 Ma.			1.25
B2-300	300 Ma.			1.50
B2-2	2.0 Amp.			4.95
B2-3X5	3.5 Amp.			6.95
B2-5	5.0 Amp.			9.95
B2-10	10.0 Amp.			15.95
B2-20	20.0 Amp.			27.95
B2-30	30.0 Amp.			36.95
B2-40	40.0 Amp.			44.95

Input: 0-115 VAC	Output: 0-90 VDC	Type No.	Current	Price
B6-250	250 Ma.			\$ 2.95
B6-600	600 Ma.			5.95
B6-750	750 Ma.			6.95
B6-1X5	1.5 Amp.			10.95
B6-3X5	3.5 Amp.			18.95
B6-5	5.0 Amp.			24.95
B6-10	10.0 Amp.			36.95
B6-15	15.0 Amp.			44.95

## THREE PHASE Full Wave Bridge

Input: 0-234 VAC	Output: 0-250 VDC	Type No.	Current	Price
3B13-1	1.0 Amp.			\$ 22.00
3B13-2	2.0 Amp.			32.00
3B13-4	4.0 Amp.			56.00
3B13-6	6.0 Amp.			81.50
3B13-10	10.0 Amp.			105.00
3B13-151	15.0 Amp.			120.00

**RECTIFIER MOUNTING BRACKETS**  
For Types B1 through B6, and Type C1 ..... \$ .35 per set  
For Types 3B ..... 1.05 per set

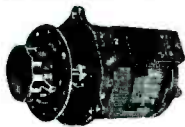

### POWERSTATS

Smooth, efficient voltage control 0 to 135V. output from 115V. AC line. Type 20. 3 Amps. \$12.50

Type 116U (Illustrated)	7.5 amps.	\$18.00
Type 112B	15 Amps.	46.00
Type 115E	45 Amps.	118.00

Also available for 230 volt input. Write for descriptive literature.

Minimum Order \$5.

All prices FOB our NYC warehouse. Send check or money order. We will ship transportation charges collect. Rated concerns send P.O., Terms Net 10 days.

## POWER SUPPLIES



**GENERAL PURPOSE Low voltage DC power supplies, with variable outputs. Rugged — Dependable — precision control.**

### Features

- ✓ Long life Full Wave Selenium Rectifiers
- ✓ Output Voltage Continuously Adjustable from Zero to Maximum
- ✓ 3" Voltmeter and Ammeter 2% acc'y.
- ✓ Stepless Control
- ✓ 5-Way Binding Post
- ✓ Instant Power—No Warm-Up Period
- ✓ Assembled and Ready to Operate
- ✓ For 115 VAC 60 Cycles
- ✓ Dimensions 9" x 9" x 17 1/2"

Write for descriptive bulletin GPA

## RECTIFIER CAPACITORS

CF-1	1000 MFD	15 DVC	\$ .98
CF-2	2000 MFD	15 VDC	1.69
CF-7	3000 MFD	35 VDC	3.25
CF-19	500 MFD	50 VDC	1.95
CF-16	2000 MFD	50 VDC	3.25
CF-21	1200 MFD	90 VDC	3.25
CF-10	500 MFD	200 VDC	3.25

Mounting clamps for above capacitors. .15c ea.

## RECTIFIER TRANSFORMERS

All Primaries 115 VAC 50/60 Cycles

Type No.	Volts	Amps.	Shpg. wt.	Price
TXF36-2	36	2	6 lbs.	\$ 4.95
TXF36-5	36	5	8 lbs.	6.50
TXF36-10	36	10	12 lbs.	9.95
TXF36-20	36	20	25 lbs.	17.95
XFC18-14	18 VCT	14	10 lbs.	6.95
XFC18-50	18 VCT	50 amp	17 lbs.	18.95

All TXF Types are Tapped to Deliver 32, 34, 36 volts. XFC Type is Tapped to Deliver 16, 17, 18 Volts Center-tapped.

## RECTIFIER CHOKES

Type No.	Hy.	Amps.	DC Res.	Price
HY5A	.028	5	.20	\$ 5.25
HY10A	.014	10	.04	9.95
HY20A	.007	20	.02	13.95

## ATTENTION MANUFACTURERS

We are in a position to furnish Selenium Rectifiers, in quantity, to specifications. Excellent delivery, prompt quotations.

*Opad-Green*  
**COMPANY**

71-2 WARREN ST., NEW YORK 7, N. Y. PHONE: BEekman 3-7385-6

## DEPENDABILITY IN ELECTRONICS

WE ARE NATIONAL DISTRIBUTORS OF PARTS, TUBES AND EQUIPMENT. WE SOLICIT INQUIRIES FROM ORGANIZATIONS WHO APPRECIATE INTELLIGENT SERVICE AND HONEST PRICES, PARTICULARLY AT THESE CRITICAL TIMES.

**NORMAN RADIO DISTRIBUTORS INC.**  
94-29 MERRICK BOULEVARD JAMACIA, N. Y. - REpublic 9-4651

## REAL VALUES!

T23/ARC5 Brand New Transmitter for VHF ..... \$29.95

## TEST EQUIPMENT

No. M-652 Jackson Audio Oscillator.....used \$30.00  
No. 155 A RCA Oscilloscope ..... used 90.00  
No. M-849 Triumph Oscilloscope ..... used 90.00  
BC-221 Frequency Meter ..... Like New 99.00  
Others as Low as .....  
IE 36 Test Set for SCR522 less meter. New 19.95

## PRICES UPON REQUEST

I-98 A	TS10A/APN
I-114 P/O RC-63	TS16/APN
I-135 P/O IE-17	TS19/APQ5
I-167 Weston Anal. #772	TS27/TSM-1
I-183 Freq. Meter	TS36/AP
I-185 Oscillator	TS47/AP
I-187 Synchronizer	TS59/APN-1
I-189 Calibrator	TS62/AP
IE-19	TS102A/AP
TS3/AP	TS126/AP
	TS-251 Less Xtal

## TUBE SPECIALS!

211	..... \$ .59	805	..... 3.29
307A	..... 4.95	807	..... 1.89
703A	..... 1.89	813	..... 6.95
723A/B	..... 12.95	837	..... 1.19
724B	..... 1.89	860	..... 4.95
803	..... 2.89	5D21	..... 9.95

ID6/APN4 Scope unit, complete with 5CP1 cathode ray tube and shield and all parts except smaller tubes and crystal. Used \$3.95 ea.

SCR 625 Mine Detector—Brand New—Price and information on request.

## MISCELLANEOUS SPECIALS!

	Used	New
RA 10 DA Receiver	\$17.50	\$24.95
RT7/APN1 Transceiver	6.95	9.95
APN 1 Complete		24.50
BC 347 Interphone Amplifier		2.95
I-70 Tuning Meter		.89
APS 13 UHF Antenna, Pair		.98
FL 8 Filter		2.95
I-97 Bias Meter	3.95	4.95
RL 42 Antenna Gearbox Motor and Reel		4.95
TS 10—Sound powered phones	6.50	
BC 1066 B—150 to 225 MC Portable Receiver adaptable to many amateur uses. In Carvass Carrying Bag. Used		\$5.95
BC 709 Battery operated lightweight interphone amplifier. Complete with tube and shock mount, but less battery		New \$3.95
C-18—Antenna coil assembly slug tuned used in IC 603 receiver. Frequency range 20-27.9 Mc.—Fully shielded		New. 10 for \$4.95
I 82—Five Inch 360 degree compass indicator and Selsyn receiver		New \$4.95
A-81-2 Transmitter Selsyn for 182 indicator.		\$2.45 (Both 182F & Trans. Selsyn for \$7.00)

AS-138/ARN—10 INCH STREAMLINE LOOP as used with direction finding receivers. Fixed position, it is ideal for planes, boats, automobiles ..... New \$1.95

## CONDENSERS

	Each
1 mfd 6000 VDC. OIL FILLED	\$1.98
.00025 mfd. 25000 VDC OIL FILLED	2.95
50 mmfd—5KV—5 Amp. Vacuum Cond.	1.19

## SCR 508 RADIO SET—Complete

installation includes:

BC 603 Receiver  
BC 604 Transmitter  
BC 605 Interphone Amplifier  
BC 606 Control Box  
DM 34—12 volt Dynamotor (Receiver)  
DM 35—12 volt Dynamotor (Transmitter)  
Set of 80 Crystals  
MP-48 Mast Base  
3 Mast sections  
FT 237 Mounting Rack ..... \$100.00  
Complete, only

## COMPASS RECEIVER MN-26

Remote control commercial type navigational receiver. Indicates direction of any desired transmitting station. 3 bands—frequency range 150 Kc to 1500 Kc; has 12-8 V. type tubes. Brand New ..... \$39.95  
Accessories for Above: Loop Transmission cable  
Loop MN-20 ..... \$9.95 —168" long ..... \$9.95  
MN-28 Control Box ..... \$10.00 MC-124 Flexible Shaft  
MN-52 Loop Control Indicator ..... \$9.95  
Unit ..... \$4.45 Set of 3 plugs. \$4.60

All shipments FOB warehouse. 20% Deposit required on all orders. Minimum order accepted—\$5.00. Illinois residents, please add regular sales tax to your remittance.

## ARROW SALES, Inc.

Dept. E6

1712-14 S. Michigan Ave., Chicago 16, Ill.  
PHONE: HArrison 7-9374

**← CHECK THESE MONEY-SAVING SURPLUS "BUYS"!**

Just Received! More

**FILAMENT TRANSFORMERS**

For hi-voltage rectifiers. PRI. 115V 5/50/60 cycle. SEC. 5V C/T @ 10 amps. 35 KV R.M.S. Test 12 KV D.C. Operating. Uses 872A tube or others. **BRAND NEW \$9.95**

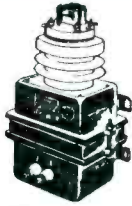

**THERMADOR J-29 Filament Transformer** Secondary 5 V CT 20 amps. 10 KV insula-tion. Cased. Heavy duty. **\$5.39**

**GRID DIP METER KITS**

Sensational Value at **\$7.95** Postpaid in U.S.A.

Selling like hotcakes for home stations, TV technicians, experimenters. Tells where your requirement is in the radio spectrum. 955 OSC. Range approx. 3 to 170 mtrs. Also ideal for Phone or CW monitor. Harmonic indicator, absorption wavemeter, measures tuned circuits, antennas, etc. PB for TVI checking. Power requirements 6.3 filament, 150 V DC. Easily obtained from your receiver, etc. Complete with instructions on Calibrating Coils, etc.



**MARK 1X AIRCRAFT COMPASS**



While They Last **\$9.95**

Orig. Gov't cost approx. \$75. Great for planes, boats, autos. Illuminated with 12 or 24 V bulb, but can be changed to cheap 6 V auto bulb without modification. Accurate floating-in-alcohol dial reads directly from the front.

**A Complete FOREIGN DEPARTMENT Fully Staffed For EXPORT ORDERS**

We maintain a complete staff of Export Specialists to take care of all Foreign Orders. Correspondence and prompt replies in all languages. Address: "Foreign Department, Alvaradio".

**WESTON AIRCRAFT METERS**

1 Milliamperes Zero Center **\$1.95 ea.** Postpaid in U.S.A.



100's already sold! PB for field strength meters, grid-dip or tuning meters, beam antenna indicators, vacuum tube volt indicators. Brand new!

**LOW PRICES ON SCARCE TUBES!**

Many May Be Available For the Last Time—Check These Prices!

RK-6S (similar to 4-250A)	19.50	5LP1	10.50
5CP1A	3.95	53A Eimac	10.50
5CP5A	3.95	3BP1	2.95
5CP11	3.95	3BP1	8.95
24G	.98	3BP5	7.95
5FP7	98	3BP11	3.50
5JP1	22.50	4E27	3.50
5JPS	22.50		9.95

Special!

**CONTACT MIKE ASSEMBLY**

100-and-1 Uses! **\$3.95** Postpaid in U.S.A.

The complete assembly consists of 2 microphones, on-off switch, amplifying transformer, batteries, battery case and connector to attach to any radio, AC, DC or Battery Portable. Tremendous amplification up to the full volume output of radio or sound system used. PB for timepiece repair, diesel engine injector adjustment, gas engine diagnosis, or theatrical or musical use.

**TS323/U FREQUENCY METER CASES**

Don't miss this unusual value—only a few left! See QST, Oct. 1950 issue for construction article regarding these useful cases. Brand new **\$3.95 ea.**

**EQUIPMENT WANTED**

Top Prices Paid for All Types of Aircraft, Radio, Radar, Test Equipment

We especially need ARC-1's, R5A/ARN7's, BC-348's, ART-13's

Try us First and be pleasantly surprised!

**SCOPE TRANSFORMERS**

**THORDARSON T17R32** Primary 115V., 60 cycles Secondary 2300 V., 2 1/2 V., shielded. \$3.95  
**HERCULES 115V. 60** cycles primary 1800 V., Secondary 6.3, 2.5, 2.5, shielded. \$3.95

**UTC LS-183 POWER TRANSFORMER.** 3500-300 CT at 400 MA. 110 or 220 Primary **\$24.50**

**UTC-LS-184 POWER TRANSFORMER.** 7000-6000-5000 CT at 500 MA. 110 or 220 Primary **\$69.50**

**UTC LS-191 POWER TRANSFORMER.** 650-500 at 125 MA. 3 Filament windings, tapped primary **\$5.95**

**UTC LS-73 POWER TRANSFORMER.** 1000-800 CT at 500 MA. 140 CT at 50 MA. 5 filament windings, tapped primary. **\$12.95**

**THERMADOR CS 10535 ISOLATION TRANSFORMER** 105, 115, 125 V to 115 V, 60 cycles. Complete with cord and plug. 250 VA. Brand new **\$6.69**

**THORDARSON SWINGING CHOKE** **\$8.95**

T-19-C-38 5-20H. 500 ma. Brand new. in original wooden box.

**ORDER DIRECT FROM THIS AD**

Prompt shipment of all orders. Cash with order. Minimum order \$3.00. 3% deposit on all C.O.D. orders. Shipments by truck or RIT Express collect. California buyers please add state sales tax. All prices subject to change. All merchandise subject to prior sale.

**ALVARADIO SUPPLY CO.**

Dept. L-11, 341 S. Vermont Ave., Los Angeles 5, Calif., DUmkirk 8-2211



1/2 hr. timer 1/2 min. grads. rings buzzer at end of time interval — Telechron Motor & Micro Switch constr. 115V. AC. 10 Amp. Cap. 10% "L., 5% "H., 3% "W. . . . \$7.50 ea.



**PRECISION LEVEL** — Interior ground tube level with 4 adjusting screws. Overall length 1 1/2", diam. 15/32". One end with shoulder 1/2" diam. **\$8.85**



**DELCO BLOWER** — sirocco type D.C. Flange diameter 3 1/4" blade 3-3/16" RPM @ 12 volts 3400 RPM @ 6 volts 1600 **\$3.95**



**SELENIUM RECTIFIERS** — G.E. model 6RS 5FB3 maximum. A. C. volts 56 D.C. amps. 0.150 **\$1.85**



**SILVERPLATED REFLECTOR**—Overall Dimensions 4 1/2", Reflecting Surface 4 1/4", Depth 1 1/4", Individually boxed 25¢ ea. **\$20.00 per 100.**



**Miniature lamp T1 1/4, 3** volt .19 amp. Airplane Indicator, Amb. Ctd. 10 for \$1.00 100 for **\$8.50**

**TELECHRON B-3-4 watt Synchronous Motors** 5/8 RPM on 50 cycles. 1 RPM on 60 cycles **\$3.50 ea.**

SEND FOR FREE BULLETIN

Telephone Digby 9-2188-9  
**A. Cottone & COMPANY**  
ELECTRONIC, MECHANICAL & OPTICAL COMPONENTS  
336-340 CAMEL ST., NEW YORK 4, N.Y.

ALL PRICES F.O.B. N. Y. CITY

**RHEOSTATS—POTENTIOMETERS—FAMOUS MAKES BRAND NEW—LARGE STOCK—AVAILABLE NOW—NEW LOW PRICES**

**25 WATT OHMS SHAFT LUGS TYPE**

15 7/16"	2	IR
15 7/16"	3	OH
25 7/16"	3	OH
25 7/16"	3	IR
25 1/16"	3	OH
35 7/16"	2	IR
40 7/16"	3	WL
60 1/16"	2	OH
70 7/16"	3	OH
100 7/16"	2	IR
100 7/16"	3	OH
200 5/16"	2	IR
250 7/16"	2	IR
350 7/16"	2	IR
370 7/16"	3	CL
2500 7/16"	3	CL

Screwdriver Adjust  
Each 89¢ — 10 for \$8.50  
100 for \$80.00

**50 WATT OHMS SHAFT LUGS TYPE**

6 7/16"	3	DJ
25 7/16"	3	DJ
225 7/16"	3	O
500 7/16"	3	CL
3000 7/16"	3	OH

Each \$1.29 — 10 for \$11.50  
100 for \$105.00

10,000 7/16"	3	DJ
Dual 250 7/16"	6	DJ

Each \$1.50 — 10 for \$13.50  
100 for \$125.00

**100 WATT OHMS SHAFT LUGS TYPE**

5 3/8"	2	OH
7.5 1/2"	3	WL
10 3/8"	3	OH
15 3/8"	3	HH
15 3/8"	3	OH
5000 7/16"	3	OH

Each \$2.25 — 10 for \$21.50  
100 for \$200.00

**75 WATT OHMS SHAFT LUGS TYPE**

15 7/16"	3	OH
300 3/8"	3	OH

Each \$1.69 — 10 for \$16.00  
100 for \$150.00

**150 WATT OHMS SHAFT LUGS TYPE**

75 7/16"	3	OH
75 7/16"	3	WL
500 7/16"	3	WL
1800 2"	3	OH
3000 7/16"	3	OH

Each \$2.75 — 10 for \$26.00

**225 WATT OHMS SHAFT LUGS TYPE**

40 7/16"	3	OH
----------	---	----

Each \$3.50 — 10 for \$33.00

**MISCELLANEOUS SPECIALS**

**RHEOSTAT—1.1 ohm—50 watt** with SPST Switch and knob. Complete assembly. **Each \$1.00**

**RESISTOR—120 Watt Koolohm** 10,000 ohms — #120KT with 15" Brass Rod-Ceramic insulators and all hardware. Individually boxed. Dozen 4.00 100 for 35.00

**TRANSFORMER—Hermetically sealed—Filament #D161917.** Pri-115V-.60 cycle-sec. 6.3V.—.6A; 2.5V-1.75 amps. New — 5 in a box. 10 for 29.50 100 for 250.00

**OIL CONDENSERS—**.15 Mid.-4,000V.D.C.—#26F386 .03 Mid.-7,500V.D.C.—#25F403 Packaged 10 for 18.00 100 for 150.00

**HIGH VOLT. CONDENSERS** .001 Mid.-7,500V.—#75026X New — Packaged 30 available

**FLEXIBLE SHAFTING—1/4" D.** Minimum quantity 500. Per ft. .05

**300 WATT OHMS SHAFT LUGS TYPE**  
2 4" 3 OH  
Each \$4.50 — 10 for \$42.50

**FUSE POST—Little fuse, Catalog #442002 — Pressurized-Finger operated knob. List \$3 With all hardware. Our Price—Dozen 3.50**

**LANDING INDICATOR METER** Two independent movements — 50 and 200 microamps Westinghouse ST #1205648. Individually boxed. 10 for 45.00 100 for 400.00

25% deposit required on all C.O.D. orders. Prompt delivery assured. Write Dept. ED. Include postage with order

**GREENWICH SALES CO.** 59 Cortland St. New York 7, N. Y.



**TELEMARINE**

The Best in Electronic Surplus

BC-610 Transmitters with BC-614 Speech Amplifier. 4 Plug-in coils and Exciter Units for 10, 20, 40, and 80 meter operation. Output 400 watts A-1, 300 watts A-3. Operates from 110/150-60 cycles AC. Used in SCR-299,399,499 eqpt. Spares available at extra cost. Condition Excellent to like new. Export Packed. **PRICE EACH**.....\$900.00

SF-1 Radar Eqpts. 10 Centimeter, Brand NEW with complete spares to insure over 10 years of continuous operation. Includes motor-generator set in each, all wave-guide plumbing, instruction books, etc. 19 cases per set, export packing. **PRICE, EACH**.....\$2,500.00

TCS, Collins Ship Transmitter-Receiver, for 12 V. DC operation, radio telephone and radiotelegraph at 20 & 40 watts, 1.5 to 12.0 mc. Complete with all accessories. Excellent, like new condition. **EACH**.....\$300.00

Beachmaster, 250 watt Portable Sound Amplifier Systems, with nine speaker rack, tubes, mike, cables, and spares. Operation from 110 volts, one phase, 60 cycles AC. Excellent and New condition units. **PRICE, EACH**.....\$485.00

Case of spares for above. **PRICE**.....\$100.00

Western Electric Model HLAS, 500 watt Sound Amplifier Systems, consisting of 40 watt Pre-Amplifier; 500 watt Power Amplifier with built-in power supply, expander-compressor circuit, internal blower-ventilation, 30 kc erasing oscillator circuit for magnetic tape recording, volume and meter controls; two speaker racks, each with 6-60 watt dynamic horn units. Operation from 115/3/60 AC. New, Unused. Complete with tubes, cables, connectors and instruction manual. **EACH**.....\$895.00

Wilcox 36A Rectifiers, single cabinet unit containing a separate transformer rectifier power supplies, capable of supplying DC voltage to one or more 90C transmitters and one or more Wilcox 50A Modulators (which are designed to modulate a 96C 3 KW RF Output Transmitter). Has terminal connections for 5 96C Transmitters, and for local or remote operation. Measures: 72" high, 29 1/2" wide, and 24 1/2" deep. Operates from 220/3/60 AC. NEW eqpt., complete with control relays, and power transformer (removed for shipment), instruction manual. **WRITE FOR PRICE.**

Wilcox 4-Channel CW3 Dual-Diversity Receiving Eqpt. Enclosed rack-panel arrangement, with 8 CW-3 receivers and 4 Diversity receiving units to provide 4 channels of dual-diversity simultaneous reception. Range 1.9 to 24.0 mc. frequency determined by plug-in coils and crystals, in shield cans. Includes BFO, sensitivity, and audio output controls on each receiver. Operates from 110/150-60 AC. NEW EQPT., with essential spares available. **WRITE FOR PRICE.**

TDE-2, Ship Transmitter, HF and IF bands, for 230V. DC operation. With internal mg supply, and all tubes. NEW, unused condition. **PRICE**.....\$600.00

T-34/ART-7 Jamming Transmitter, uses 2-Elmac 35TG tubes in push-pull oscillator, with motor-driven condenser to provide complete frequency sweep of intended spectrum. Frequency approx. 60-80 mc. For 28 V. DC. operation. NEW, metal-cased transmitters only (less power supply), with 2 35TG tubes, export-packed. **PRICE, EACH**.....\$22.50

AN/CRT-1A Sonobuoy Transmitters, for mine and submarine detection. With parachute, tubes, etc., ready for operation (except standard type dry batteries). Operates at 67.5 mc. Excellent to New condition. **PRICE, EACH**.....\$55.00

T-9/APQ-2 Radio Transmitters. Noise-modulated Jamming Transmitter, using Electron Multiplier Photocell. For jamming certain types radar eqpt. New unused transmitters only, with Electron-Multiplier tube, less other tubes. **EACH**.....\$32.50

SB-23/GTA-2 & SB-14/GY Switchboards & Power Supply, for operation from 110V. 60 cycles AC (with storage batteries). Each in individual metal cabinet. NEW. **Price, Each Set**.....\$450.00

**"SNOOPERSCOPE" TUBE**

Infra-Red Image Converter Tube (Bristle) to make "Snooperscopes," "Sniper stands," and other devices that see in the dark. Has many useful industrial applications. Operates with invisible infra-red rays, without scanning or amplifiers. Supplied with technical data and diagrams. Every tube guaranteed! **EACH**.....\$5.50

6 for \$30.00

BAUSCH & LOMB Front-End Lens Assembly, for best images. F2.1, 3.5 in. E.F. **EACH**.....\$10.00

**MOUNTED LENS UNIT**, also for front-end, results as good as B & L unit. Speed F1.9 f. 1, 91.44 mm, outside dia. at one end 60 mm, length of mount 64 mm. **PRICE, EACH**.....\$7.00

**LIMITED QUANTITIES Following:** R-89/ARN-5A Receivers, new; APN-4 Indicators; TR-2 Portable 28-80 mc Transceivers; TAJ-12B Transmitters; Model NAA Underwater Ultrasonic Beacon Transmitters; Model ZB-3 Aircraft Homing Adapter Equipment; Portable Test Oscillators for ZB Eqnt; RT-3/ARN-1 Avimeter Transmitter-Receiver; Receivers for DP-12 or 13 D.F. Receiving Eqnt; Radio Receivers BC-733-D; BC-329 Small Aircraft Lo-Freq. Transmitters; Model DAG-1 Portable 1.5 to 18.0 mc D.F. Receivers; Model ATD Aircraft Transmitters; BD-72 Switchboards; 500 Watt, 110 DC to 110 AC, 60 cps motor-generators, Beck Entrance Insulators, bond and bond type, 5/8" dia. with heavy galvanized metal flange and bell. Top bell 6 1/4" dia. x 1 1/2" brass feed thru rod. Very high voltage insulation. Individually packed in cartons, all NEW. 12 FOR.....\$24.00

General Electric Amplidyne M.G. Set, generator type #V-587507, motor type #73AF58, Navy #CG-21A1B1, 15-230 V., 60 cycles, motor rated at 3/4 HP, generator output 250 V. DC at 375 watts. NEW. **PRICE, EACH**.....\$75.00

Prices quoted are NET, FOB N.Y.C. our warehouse

**TELEMARINE**  
**COMMUNICATIONS COMPANY**

540 West 27th Street  
NEW YORK 1, NEW YORK  
Cable Address: Telemarine, N. Y.



\$1.45

**10 mfd. at 600 volts d-c**

- Oil impregnated
- Oil-filled
- Hermetically sealed

in squeeze-seam cases 3 3/4 x 3 3/4 x 2 inches with rigid flange for inverted mounting on 17/16 x 3 3/4 inch centers.

**TOBE DEUTSCHMANN CORPORATION**  
NORWOOD, MASSACHUSETTS

**RESISTORS**

IMMEDIATE DELIVERY in all preferred values from fractional ohms to 47 megohms.

DOMESTIC CARBON RESISTORS in 1/2 and 1 watt. Tolerances in 5%, 10% and 20%.

Also Suppressors Available From Our Stock.

**STANLEY ENGINEERING & MFG. CO.**

114 Liberty St., New York 6, N. Y.

Phone: Digby 9-0454

**SAVE ON SURPLUS!**

All Material Guaranteed!

- TYPE "J" POTS**  
Send Requirements.....\$1.10  
Most Sizes and Tapers Available.
- ROTARY SWITCHES**  
One Pole, Eleven Throw, 1 Wafer......45  
Two Pole, Eleven Throw, 1 Wafer......60  
2P3T—One Wafer......40  
3P6T—Three Wafers......45  
7P3T—Seven Wafers......55
- RELAYS**  
SIGMA, Sensitive, SPDT, 2 Volts, 130 Ohms.....\$1.95  
SIGMA, 10,000 Ohms; 2 Mils.; SPDT..... 2.95  
G. E. 10,000 Ohms; 10 Mils.; 3PDT..... 5.95
- SPECIAL**  
GE Kilowatt Hr Demand Totalizer Meter Has 1 RPM Synchr. Motor-120 Volts, 60C—less case.....\$1.25
- F M ELECTRONICS COMPANY**  
92 East End Ave. New York 28, New York

**SURPLUS COMPONENTS FOR SALE**

Bathtubs, oils, micas, xformers, chokes, relays, trimmers, sockets, odd items, etc. Surplus lots purchased. **EMPIRE ELECTRONICS**  
Box 41, Midwood Stat., Brooklyn 30, N. Y.  
Phone BRyant 9-1220

**FOR SALE**

New and used BC-654 (part of SCR-284) portable transmitter-receiver sets, 3800-5800 kc, with PE-103 dynamotor, PE-104 power pack, GN-45 hand generator. **ARROW APPLIANCE CO.**  
525 Union St. Lynn, Massachusetts

**ELECTRONIC TUBE-MAKING MACHINERY**

For manufacturing radio tubes, electronic tubes, cathode-ray tubes, lamps. New and used. Reasonably priced, satisfaction guaranteed. **AMERICAN ELECTRICAL SALES CO.**  
67 E. 8th St. New York, N. Y.

**RECTIFIER POWER SUPPLY**

McColpin Christie Model MH 24-25, input 230 v 60 cy. 3 ph. Output 25 amps. 24-28 v DC. Continuous duty, fan cooled. 13" x 13" x 19". Price \$75.00 each net. New. \$215.00 value. **LEO SAGAL CO.**  
860 Glenmont, L. A. 24, Calif.

**WANTED**

**MANUFACTURERS — LABORATORIES — INDUSTRIALS**

We will buy your complete inventory of electronic components.

**RESISTORS — TUBES — CONDENSERS**

Send us your list. Quick action. We need everything. We pay highest prices.

**ELECTRONIC SURPLUS BROKERS**

148 Chambers St.

Rector 2-1591

New York 7, N. Y.

**WANTED**

Teletypewriters complete, components or parts. Any quantity and condition.

W-6864, Electronics  
330 W. 42nd St., New York 18, N. Y.

**WANTED**

**WESTERN ELECTRIC VACUUM TUBES**

Types 101F, 102F, 272A, 274A or B, 310A or B, 311A, 313C, 323A, 328A, 329A, 348A, 349A, 352A, 373A, 374A, 393A, 394A, 121A Ballast Lamps.

W-6863, Electronics  
330 W. 42nd St., New York 18, N. Y.

RC-184 IFF EQUIPMENT  
BRAND NEW. COMPLETE  
SCR-584 PARTS

APS-4 RADAR COMPLETE

APS-6 RADAR COMPLETE  
MARK 16 RADAR COMPLETE

MG19A NEW

MK20A/UP, NEW, INDIVIDUALLY BOXED  
MK20A/UP NEW, INDIVIDUALLY BOXED

BC-110-A TRANSMITTER  
WITH REMOTE CONTROL. 125 W. 115 VDC OR AC.

## TELEVISION CAMERA

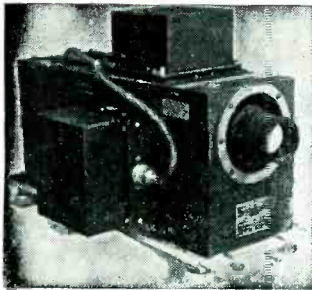

3350 line resolution. Easily converted to present RMA standards. Circuits available with camera. Complete, like new.

### COMPLETE LINE OF TEST EQUIPMENT:

DUMONT 224-A OSCILLOSCOPE  
TS-36/AP TS-102A/AP  
TS-108 TS-184A/AP  
1-77 HICKOK TUBE CHECKER  
UPM-1 COMPLETE TS250/APN  
BC-221 FREQUENCY METER  
RPC MODEL 644 MULTIMETER  
FERRIS MICROVOLTER MODEL 18B

### WE WANT THIS EQUIPMENT:

BC-348 ART-13  
BC-611 ARC-1  
RTA-1B ARC-3  
BC-1000 R5A/ARN7

## COLUMBIA ELECTRONICS LTD.

524 S. SAN PEDRO ST.  
LOS ANGELES 13, CALIF.

11816 VENTURA BLVD.  
N. HOLLYWOOD, CALIF.

Cable Address: COELECT

## D.C. MICROAMMETERS

0-200 ua 3" sq. G.E. DO 50.....\$ 9.00  
0-100 ua 3" sq. G.E. DO 50..... 10.00  
0-50 ua 3" sq. G.E. DO 50..... 12.00

## PRECISION PORTABLE INSTRUMENTS

Single or multi-range

L. T. Microammeters, from 5 ua full scale.  
Thermo-couple Milliammeters, from 1.5 Ma. Thermo-couple voltmeters.

## Precision Electrical Instrument Co.

146 Grand Street New York 13, N. Y.

# TRANSMITTERS

## RCA Model MI-8167

All NEW packed for export,  
LARGE QUANTITIES AVAILABLE for IMMEDIATE DELIVERY.

Freq. Range: 2000 to 20,000 Kcs.

Output: 350 Watts C. W.  
250 Watts Radiophone

Input: 190 to 250 Volts AC 50/60 cps.

The MI-8167 was made for the US Army Point-to-point ground communications use. Extremely compact (Size: 60" high, 17" wide, 27" deep) and shock mounted. High speed keying and High Level Class "B" 100% modulation incorporated. No external coils needed—built-in band switching, antenna tuning, all front panel instantaneously operated. Complete with ten new tubes, built-in shielded oscillator unit (choice of M.O. or Crystal units), fully metered, with or without external speech amplifier. Net weight 570 pounds.

Modern design and current model. Can be installed quickly and easily on land, on ships, or on mobile trucks.

### QUANTITY DISCOUNTS

Prices on request

We stock other transmitters and communications combinations and accessories in all power types, from walkie-talkies up. Also portable RADAR and Search Receivers. *Bulletins available.*

# COMMUNICATION DEVICES CO.

2301 Twelfth Avenue, New York 27, N. Y.

Cable: Communidev

Tel: AD-4-6174, 5

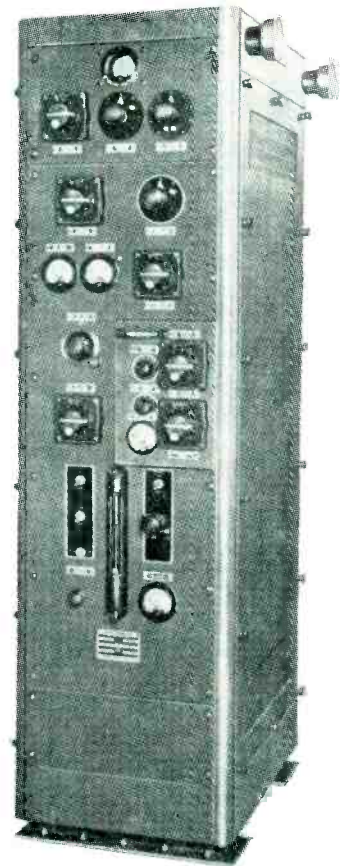

**RADAR**  
SCR 545A Search and Track. Complete trailer, power supply and spare parts. Nearly new. Write for description and price.

**PORTABLE PUMP ASSEMBLY**  
Leland, 110 v. 60 c. 1 ph. 1/3 H.P. motor and D. Roper #2 hydraulic pump. 300 lbs PSI max., 125 lbs. PSI continuous @ 3.25 gallons per min. ....\$52.00

**SEARCH LIGHT**  
Signaling, 12" Curtis Lighting, Inc. 115 v. a-c or d-c, 1000 watt. Complete w/bulb. Comes w/mounting assembly that gives 360° horizontal rotation and 180° vertical rotation. ....\$27.50

**AUTO-DRYAIRE**  
Model 220, 115 v. 60 cy. for pressurizing high altitude electronic equipment. ....\$160.00

**MOTORS**  
General Electric geared, 27 v. d-c @ 0.7 a., 110 RPM, 1 oz/ft torque. \$33.50  
Electric 1/15 H.P., 115 v. 60 cy. 1 ph. 1800 RPM \$4.75

**GENERATOR**  
Bendix model NEA3. Output 115 v. a-c 10.4 amps, 800 cy. SP, and 28.5 v. d-c, 60 amps @ 2400 RPM. Self excited, splined drive. New. Orig. packing. \$27.50

**RECTIFIER**  
Dry Disc, 6.5 v. a-c FWCT. 2.2 v. d-c @ 3 amps. ....75¢  
Westinghouse Transformer 18,430-0-18,400 v. @ 9 KVA continuous. Westinghouse Filament Transformer, 11.5 v. @ 40 amps. Both transformers have 115 v. 60 cy. 1 ph. primaries. Westinghouse Choke, 50 h. @ 575 ma., insulated for 17,500 v. continuous. (2) WL-531 rectifier tubes, 50,000v peak inverse. Complete \$160.00

**POWER SUPPLY COMPONENTS TRANSFORMERS**  
Plate, American Transformer Co. Spec. 29108. Pri. 115 v. 60 cy. 10.4 KVA. Sec. 17,600 v., 520 amps., 25 KVA test. \$65.00  
Plate, American Transformer Co. Spec. 29108. Same as above but center-tapped to handle 1 amp @ 8800 v. ....\$75.00

Filament, American Transformer Co. Spec. 29106. Type WS, .050 KVA, 50/60 cy. SP., 35 KVA test, 12 KV d-c operating. Pri. 115 v., Sec. 5 v., 10 amps. w/integral stand-off insulator and socket for #571, 872, etc. rectifier tubes. ....\$12.50  
2 for \$22.50—4 for \$40.00

**CAPACITORS**  
9.12 mfd., 1265 v. 60 c. a-c or 4000 v. d-c power factor correction 5.0 KV. A.R. Cat. #2528908, ....\$17.50  
25-.25, 6000 v. d-c or .125 @ 12,000 v. d-c. Fast Cat. #A7549, oil. ....\$3.75  
1.25/1.25 mfd., 7500 v. Cat. #26F360 \$12.50  
1.0 mfd., 25,000 v. d-c., Cat. #14F59 \$36.00  
2x.15 mfd., @ 8000 v. or .075 mfd. @ 16,000 v. Vitamin Q. ....\$2.90

**RESISTORS**  
Fixed, w.w. 160,000 ohm, 200 w. ferrule ends \$1.00  
Fixed, w.w. 5,000 ohm, 200 w. ferrule ends \$1.00

**METERS**  
Volt Meter, 3" Weston Model 301, 1 ma f.s. calibrated 0-20 KV d-c w/Weston 20 meg. precision meter multiplier, stand-off insulators and clips. ....\$18.00  
Meter only, less multiplier. ....\$ 4.95  
Ammeter, a-c 3" Westinghouse NA-35 or Weston Model 476, 3 amps. f.s. deflection; scale calibrated 0-120, includes doughnut type current transformer w/200-5 ratio at 25-133 cy. ....\$8.50  
Volt Meter 3" Weston Model 301, 4 KV d-c, 1 ma. f.s. calibrated 0-4 KV w/4 meg. Weston precision multipliers. ....\$7.50

**RELAY**  
Magnetic overload, Allen-Bradley #810, 6.3-18.1 amps. 600 v. max. ....\$7.95

**WIRE**  
Simplex type S. 600 V. (19) conductor #18 A.W.G. Approx. 1000' reels. ....\$170.00/M'

**CONTACTOR**  
Allen-Bradley & Westinghouse, 115 v. 60 cy. coil, DPST, 15 amps. ....\$4.95

**HIGH VOLTAGE RECTIFIER POWER SUPPLY**  
Variable output 0-15,000 v. d-c @ 500 mils. Input 115 v. 60 cy. SP. Army type RA-38. Size 63 3/4" x 53 3/4" x 56 7/8". Wt. 2040 lbs. Units are new, complete with spare tubes and remote control. Write for detailed information.

# NEW!

- low prices
- values
- equipment
- components

Note: All merchandise not designated as new is guaranteed to be in excellent to new condition.

## EPCO

1527 E. 7th St.  
Los Angeles 21, Calif.



# BRAND NEW STANDARD BRAND TUBES

OA3/VR75	\$1.29	2V3G	1.19	7E6	.69	450TH	39.50	801A	.49	865	1.39	8011	.98	CATHODE RAY	
OB3/VR90	1.25	2X2	.75	7F7	.95	450TL	44.50	802	4.49	866A	1.25	8013A	6.49	TUBES	
OC3/VR105	.99	2X2A	1.43	10Y	.35	530	12.50	803	3.95	869B	39.50	8014A	24.95	3CP1/S1	1.95
OD3/VR150	.95	3A4	.55	10Y	.75	531	3.95	804	9.95	872A	1.95	8020	1.50	3DP1	4.95
IA3	.95	3B7	1.29	24C	1.95	559	3.95	805	3.95	874	1.49	8021	2.89	3DP7	1.95
1B22	3.25	3B22 ELIC	2.75	39 44	.49	700A	17.50	807	1.69	876	1.43	8025A	7.95	4AP10	4.95
1B23	8.50	3C24 24G	1.95	45 Spec.	.35	701A	4.95	810	10.95	879	1.43	8025A	7.95	5A1	3.49
1B24	6.75	3C28	4.95	100TH	8.75	702A	3.49	811	2.95	931A	4.50	9003	1.75	5CP1	3.95
1B26	2.75	3D6 1299	.49	152TH	19.95	703A	7.49	812	2.95	954	.35	9004	.45	5CP1A	4.95
1B27	19.95	3D21A	1.98	203A	8.75	704A	1.00	813	8.49	955	.45	9005	1.90	5CP7	3.95
1B29	4.75	3D23	4.95	205B	3.95	705A	2.89	814	3.95	956	.69	9006	.35	5F1	3.95
1B36	23.75	3F29	13.50	211	.75	707A	12.95	815	2.49	957	.35	C5B	8.95	5F7	3.95
1B56	47.50	4A1	1.75	217C	18.00	707B	17.50	829	11.95	958A	.49	C6A	6.95	7BP5	18.95
1B8GT	.89	4B28 S2894	4.75	250R	18.95	708A	4.75	829B	13.95	959A	.69	C6J	5.95	7BP7	6.95
1L4	.89	4E27 257B	15.95	250TH	23.25	710A	.98	830B	3.75	1608	4.95	CRP72	1.98	9LP7	12.95
1R4 1294	.69	4J42 700A	17.50	250TL	19.95	713A	1.25	832A	8.95	1609	4.65	E1148	.75	10BP4	18.95
2C22 7193	.35	5D21	24.50	285A	8.95	714AY	5.75	832B	8.95	1613	.99	FG81A	7.69	12LP4	21.50
2C26	.39	6AJ5	2.25	286A	14.95	715B	12.75	833A	43.95	1616	2.29	FG104	19.95	12LP4A	22.25
2C34 (RK34)	.29	6B8	.98	384TH	18.95	715B	12.75	836	2.95	1622	1.25	HY615	2.50	14BP4	26.50
2C40	4.95	6C8	.88	310A	6.95	715C	24.50	837	1.65	1624	1.25	HY114B	2.50	16BP4A	34.00
2C44	1.49	6C24	27.50	316A	1.50	721A	2.25	838	2.95	1625	.45	HY615	.29	16BP4	37.00
2J22	7.95	6F4	5.75	329A	8.95	722A	2.49	846	49.95	1629	.35	RK25	3.95	17BP4A	37.00
2J26	24.50	6J4	5.95	331A	14.95	723A/B	14.95	851	49.50	1634	.48	RK34	.29	19AP4A	62.00
2J36	89.50	6K7G	.69	331A	14.95	723A/B	14.95	860	5.95	1642	.98	RK72	1.65	19AP4B	62.00
2J61	48.75	7A7	.89	353A	4.95	724B	3.75	861	24.50	1665	1.25	RT73	1.65	20CP4	68.50
2J62	48.75	7C4	.95	371B	.95	725A	6.25	864	.75	7193	.35	VT90	.98		
2K25	24.95	7E5	.79	388A	1.50	730A	8.95								

## MARITIME INTERNATIONAL COMPANY

11 State Street, New York 4, N. Y.

Cable Address "Foxcroft"

Phones: Dlgby 4-3192-3

# SURPLUS EQUIPMENT

### INVERTER UNIT PE 218

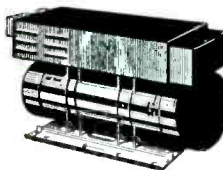

Output: 115 VAC;  
Single phase, PF 90;  
380/500 cycle; 1500  
V.A. Input: 25-28  
VDC; 92 amps; 8000  
rpm; Exc. volts 27.5;  
Leland Electric mfg.

**BRAND NEW \$29.95**

### POWER TRANSFORMERS

Primary 125 volts tapped at 105 and 115 volts, 50 to 425 cycles. Secondaries: 5.1 V. at 3.0 amps; 325-0-325 V. at 0.175 amps; 5.4 V. at 8 amps; 6.4 V. at 10.3 amps; 2.5 V. at 3.0 amps; 4500 V. at .005 amps; 2.5 V. and 4500 V. windings insulated for 6000 Volts. All other windings insulated for 1500 Volts. Cost gov't more than \$42.00... a real bargain at (removed from new equipment)

**\$4.95 ea.**

### BLOWER UNITS



Single exhaust with squirrel-cage type fan. Intake 2 1/2"; Outlet 2". Delivers approx. 55 cu. ft./min. 115V-AC (60 Cycle) DELCO motor. Simple to install for any use. Govt. cost more than \$20.00.

New..... \$9.95

### ONAN MOTOR GENERATOR SET

#### MG 075-G-1

Generator 115 VAC;  
480 cycle; 5.3 Amps;  
.6KW; PF 1.0; Also  
26 VDC; 100 watt;  
3.8 Amps. Driven by  
115-230 VAC - 2hp  
motor; 60 cycle;  
single phase; 3450  
rpm; 10.5 amps.

**BRAND NEW**

**\$195.00**

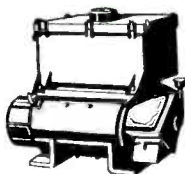

### BLACK LIGHT KITS

#### Ultra-Violet Fluorescence

Now... build your own black light lab equipment at a new low cost with these easy - to - assemble components. Kit contains: Ultra-violet tube brackets, ballast, starter, wire, plug and wiring diagram.



4-Watt Kit—5 1/2" tube ..... \$3.00  
8-Watt Kit—(12" tube) ..... \$4.00

### PIONEER AUTOSYNS

AY 1: 26 Volts; 400 Cycle..... \$4.95 Each  
AY 5: 26 Volts; 400 Cycle (Has hollow shaft) ..... \$5.95 Each

Write for your requirements on FT 241-A Crystals and Holders

We Have a Wide Assortment of Frequencies.

ALL EQUIPMENT F.O.B PASADENA • PLEASE SEND FULL AMT. WITH ORDER

**C and H Sales Company**

BOX 356-E EAST PASADENA STATION • PASADENA 8, CALIFORNIA

### 10 MFD..... 400 VOLTS..... 57 CENTS

Although rated at 400V against an operating temperature of 72°C, these nationally famous 5+5 MFD capacitors will meet all commercial specifications and operate at 600V provided that the operating temperature does not exceed 40°C. Measuring 3 5/16 x 2 x 3 25/32 and packed 24 to a carton, weighing 42 pounds this item fills the need for an excellent filter and power correction device. Long lasting, extremely low in dielectric leakage and available in sufficient quantity for a large manufacturer. Small quantities—\$.57. Carton quantities—\$.45. Samples upon request.

WESTON LABORATORIES

Weston 93, Massachusetts

### SCARCE BUYS!

METER—Freq. 350-450 cycle, 90-140V, 1/3 of 1% Acc., for aircraft shop, etc. New..... \$ 24.00  
300 OHM—good TV line per ft..... .05  
72 OHM—twin line, 7/21 wire, 1 KW. ft..... .05  
95 OHM—2 wire shielded coax, ft..... .05  
REPLASTIC TUBING—#20 wire, 1500'..... 5.95  
SELENIUM RECTIFIERS—full wave bridge, 12V. 30 Amp. D.C. (other types in stock) 17.95

### SELENIUM POWER SUPPLIES

6-8 V.—5 Amp. \$9.95; 12—15 V.—10 Amp. 17.95  
Write for other types, with meters, Variacs filters, etc. Also heavy duty types.  
4000 MFD—30V. Elec. Condenser..... 2.95  
7 AMP. CHOKE—#3 Henry..... 3.95  
3 MFD—400V. Oil Cond..... 5.95  
723 YB TUBES—Ind. boxed; new..... 14.95  
TV RECEIVER TUBES—write for cut prices.

B.C. 22IN FREQ. METER—new condition. 125.00  
DUMONT SIG. GEN.—2-125 CPS. L.N. 150.00  
B.C. 423 SIG. GEN.—pulse. TV. Freq. 19.00  
B.C. 224—312. 318. good condition. 49.00  
ARC. 5 REC.—3-6 mc. no dial & drive LN. 4.95  
HAM XMITTER—500 watt phone, deluxe. 195.00  
HAM XMITTER—150 watt phone—CW. 95.00  
RACK CABINET—19 lg. 8 3/4 H. 13 dp., new 5.95  
XCRALS—ASTIC 8050 KC in 25K step. 59.00  
TV SETS—19" x 25" screen, recond'td. 195.00  
TV CHASSIS—recond'td. sweep circuits. 29.00  
30 KV supply \$30.00; Proj. optical system. 49.00  
supply \$22.00; Proj. optical system. 49.00  
GF/RO COIL SETS—for Rec. & Xmitter. .95  
KNOBS—Bk. Rd. 1 1/4" Dia. Wh. arrow, 25 1.00  
RELAYS—24V. DC removed from equip. 49.00  
clean. D.P.D.T. 10 Amp. \$.25; SPST. DB 30 amp. .50

### TRANSFORMERS

230/460V. .750 KVA, use for 110/220V. New. 8.95  
5V.-115 Amp.—115 V. Primary. 13.95  
11-13 V. 1KVA—110V. Pri. good condit. 19.00  
24V. 4KVA—220/440 V. Pri. 3 phase, new. 49.00  
8.5V. 5KVA—220/440V. Pri. 3 phase, new. 65.00  
8.5V. 10KVA. 220/440V. Pri. 3 phase, new. 95.00  
DECK ENTRANCE INSULATOR—9" Dia. bowl, new 2.00  
SUPER PRO.—with power supply & speak. 165.00  
10 KV. RE-SUPPLY—6-10KV. for TV, etc 21.95  
BC 375 XMITTER—all TUB'S & Dyn., new. 59.00  
CABLE—9 & 10 cond. shielded, 10, 15, 20 ft. .10  
TV CHASSIS—has AM-FM & Video IF & Audio. Less front end, tubes & power supply, new 11.95  
FM TUNER—Foundation Unit, no tubes, new 4.95  
SIG. GEN.—measurements—Mod. 78B near 149.00  
Prices subject to change without notice for HEMP. 25% on COD orders.

ALGERADIO ELECTRONICS CO.  
385 Jackson St. Hempstead, N. Y.

### TUBES

New Standard Brand 3B25 only \$3.00 ea.  
7C7 .90 ea.  
6SH7 1.10 ea.  
6C6 .50 ea.

Send for our list of more bargains in surplus components like these!  
NEW ENGLAND ELECTRONICS CO.  
P. O. BOX 92. BRIGHTON 35, MASS.

### HIGH TENSION CABLE

Portable, Shielded, #10 AWG. Neoprene Jacket. Will bury 25,000-VAC or 35,000-VDC.

\$436.80/1000-ft.

CUNNINGHAM ENGINEERING CO.  
Beaumont, Texas

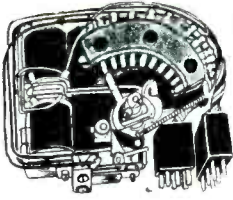

**Automatic Electric**  
**2 Decks 10 Points**  
**TELEPHONE RELAY**  
24 Volts D.C.  
**\$11.00**

**NEW HOLTZER-CABOT**  
**TOTALLY ENCLOSED MOTORS**

50 R.P.M. Reversible Single Phase Capacitor-Run type. 115 Volts AC 60 cycle 0.3 Amp. Torque 100 oz. Inches. 4 3/4" shaft 5/8" dia.

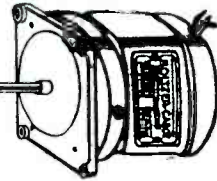

**\$17.50 each**

**ANNUNCIATOR DROP**

250 ohms, will drop on 12 volts or more  
**\$1.00**

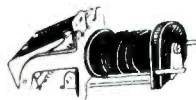

**HOLTZER-CABOT M.G. 218. CONVERTER**  
**400 CYCLE 110V A.C. 1 AMP**  
**1/4 H.P. D.C. 110V MOTOR** **\$49.50**

EST. 1923 **BLAN** EST. 1923

64 Dey St., New York 7, N. Y.

WE 24 & 12 volt Telephone lamp...doz. **\$1.50**  
CH 4 pole 35 ampere 115v. AC relay. **\$4.90**  
GE 3 ampere Mercury Switch 1/2" glass tube...3 for **\$2.50**

**Genuine TELECHRON Motors**

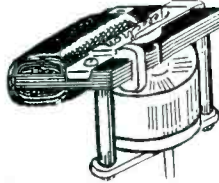

2 RPM .....\$2.90  
3.6 RPM ..... 3.15  
1 RPM ..... 3.95  
60 RPM ..... 4.30  
One of Each \$12.00

Stevens-Arnold Resonant Relay. Only two types in stock. 442 and 240 CPS either one. **\$4.50**  
Both for \$8.00

**ALNICO** **LUCKY** **7% COBALT**  
PURCHASE ENABLES US TO OFFER YOU THESE *Actual*  
**MAGNETS**  
**39¢ EACH** **3 FOR \$1.00**

**ISOLATION TRANSFORMER \$1.95**  
Lat. known Mfrs. 50 watt 2 windings. 115 V. to 115 V. 60 cy. Ideal to prevent shocks from small radios and medical and electronic devices.

**ELAPSED TIME METERS**



**\$15.50**

**GONIOMETERS**  
Micro Switch  
Solenoids  
Relays  
Electric Counters

**"TAB"**  
**That's a Buy!**



**Precision Resistors—**

Over 2 1/2 Million in Stock

No Mfrs. Choice—We Ship Types in Stock

0.116	209.4	700	1919	6140	23400	147000
0.42	216	711	1922	6200	23500	150000
0.425	220	733	1924	6300	24000	155000
0.607	220.4	740	1926	6495	24400	160000
0.7	225	750	1960	6500	25000	165000
1.03	230	800	1980	6840	25200	166750
1.3	235	806	2000	6990	25400	167000
1.75	240	850	2045	7000	25833	169200
2.5	245	854	2080	7320	26000	175000
3.5	245.4	890	2095	7400	26500	180000
3.83	250	900	2141	7700	26600	180600
4.35	260	910	2142	7717	27000	185000
5	271	917	2145	7900	27500	186600
5.025	275	946	2150	7930	28000	190000
6.25	280	978	2160	7950	28430	198000
6.5	286	1000	2180	8000	28500	200000
7	289	1030	2187	8094	29000	201000
7.8	299	1056	2195	8250	29500	205000
7.9	300	1059	2200	8500	29990	210000
8	310	1067	2250	8700	30000	215000
10.38	311.5	1100	2300	8770	31000	220000
11.25	320	1110	2400	9000	31500	225000
12	325	1150	2450	9100	32000	229000
13.52	330	1155	2463	9445	33000	230000
14.2	340	1162	2485	9500	35000	235000
14.25	350	1200	2490	9710	37000	238000
14.5	360	1225	2500	9800	38140	240000
15	366.6	1250	2525	9900	38500	245000
16	370	1260	2600	9902	39000	250000
17	375	1300	2625	10000	39500	265000
19	380	1350	2635	10340	40000	268000
19.2	389	1355	2700	10500	42000	270000
20	390	1400	2750	10500	43000	275000
22	400	1488	2850	10900	45000	294000
23	410	1495	2860	10936	47000	300000
24	414.3	1500	2870	11000	47500	307000
25	418.8	1510	2900	11400	48000	311000
26	425	1518	3000	11500	48660	314000
28	426.9	1600	3100	11600	50000	316000
30	427	1640	3163	12000	50900	324000
31.5	440	1646	3259	12500	52000	330000
37	450	1650	3290	12600	55000	330000
48	452	1670	3333	13000	56000	333500
49	460	1680	3384	13100	57065	350000
50	470	1710	3400	13500	58330	355000
51.78	475	1712	3509	13550	60000	375000
55	478	1740	3700	13600	61430	380000
56.7	480	1770	3730	14000	62000	400000
60	487	1800	3760	14250	64000	402000
63	500	1818	4000	14400	65000	420000
68	520	1830	4030	14600	66600	420000
74	525	1865	4200	14550	66650	425000
75	540	1892	4220	14600	67500	450000
80	550	1894	4280	15000	68000	458000
81.4	575	1895	4300	16000	70000	478000
88	580	1896	4314	16500	72000	500000
89.8	588	1897	4440	16800	73500	520000
95	600	1898	4444	17000	75000	521000
100	612	1899	4500	17500	80000	525000
101	625	1900	4720	17977	82000	543000
105	635	1901	4750	18000	84000	550000
105.7	640	1902	4850	18500	85000	570000
107	641	1903	4885	18380	85750	575000
120	645	1904	4900	18500	88000	600000
121.2	649	1905	5000	18800	90000	620000
125	650	1906	5100	19000	91000	650000
130	657	1907	5210	19500	93300	654000
135	665	1908	5235	20000	95330	655000
147.5	668	1909	5270	20441	100000	690000
150	670	1910	5300	20500	110000	700000
160	673	1911	5500	21000	115000	750000
165	675	1912	5600	21500	116667	761300
170	680	1913	5730	22000	120000	800000
175	681	1914	5770	22500	130000	813000
179	684	1915	5910	22990	135000	850000
182	689	1916	6000	23000	140000	900000
182.4	697	1917	6100	23150	141000	930000
200	699	1918	6125	23325	145000	950000

Any Size Above, Each 35c; Ten for \$3.29

Mega-1.	1.5	2.11	3	4.25	7
1.1	1.57	2.2	3.3	4.5	7.5
1.2	1.579	2.25	3.5	5	7.62
1.25	1.65	2.5	3.673	5.5	8.74
1.3	1.75	2.7	3.75	6	8
1.35	1.8	2.75	3.9	6.5	8.02
1.39	1.9	2.8	4	6.6	8.5
1.4	2	2.855	4.23	6.7	10

Any Size Above, Each 70c; Ten for \$6.49

**IN STOCK . . .**

- 9,000 Antennas
- 4,000 Batteries
- 300,000 Capacitors
- 20,000 Chokes & Coils
- 15,000 Circuit Breakers
- 1,000 Clock Motors
- 40,000 Connectors
- 12,000 Piezo Metals
- 1,200 Dynamos
- 15,000 ft. Film
- 1,250,000 Fuses & Holders
- 10,000 ft. Spaghetti
- 45,000 Insulators
- 5,500 Motors
- 25,000 Rotary Switches
- 20,000 Tagg Switches
- 15,000 Microswitches
- 100,000 ft. Wire & Cable
- 5,000,000 pcs Hardware, Lugs
- 2,500 Headsets
- 2,300 Line Filters
- 27,000 Pilot Lights
- 2,000 Selsyns
- 1,000 Blowers
- 1,100 Tach Generators
- 2,500 Rectifiers
- 27,000 Relays
- 250,000 MW Resistors
- 2,500,000 Precision Resistors
- 65,000 Potentiometers
- 23,000 Rheostats
- 6,000 Tech Manuals
- 50,000 Tube Sockets
- 500,000 pcs Telephone Equip. (jacks, plugs, lamps, etc.)
- 40,000 Transformers
- 250,000 Tubes
- Millions of Odds 'N' Ends

Government Contractors, Quantity Users—Write for Your Needs On Your Company Letterhead

**"TAB"** Dept. 3E, 6 Church St. Corner Church & Liberty Sts. New York 6, N. Y. That's a Buy! WOrth 2-7230

**TUBES**  
**LARGE STOCK**

Most All Types

Write Us Your Needs

Subject to Prior Sale

**NAT ADELMAN**

168 Washington St., N.Y. 6, N.Y.

C07-6091

We Buy Surplus Stocks of  
Tubes and Electronic Parts

**SHEET METAL MACHINERY**

NEW and Used—Brakes—Shears  
Forming Rolls — Folders — Punches —  
Di-Acro, Pexto, Niagara & Whitney Equip-  
ment.

**B. D. BROOKS CO., INC.**  
HAncock 6-5200  
361 Atlantic Ave., Boston 10, Mass.

**WHOLESALE ONLY**

**ELECTRONIC COMPONENTS**  
**AIRCRAFT EQUIPMENT**  
**HYDRAULICS**

**RADIO & ELECTRONIC SURPLUS**  
13933-9 Brush St. Detroit 3, Mich.  
Phone Townsend 9-3403

**TENNEY**

**High Altitude Chamber**

Temperature Control minus 70°F to plus 125°F  
Humidity control up to 95%  
Altitude control sea level to 53,000 ft.  
Used little, like new

**KINGS COUNTY MACHINERY EXCHANGE**  
408 Atlantic Avenue, Brooklyn 17, N. Y., Deot. "E"

**LOOK! IT'S A WHALE OF A**  
**SALE at PLATT**

Visit our **BIG Retail Store** at  
489 **BROOME ST., N. Y. C.**

**FREE! WRITE FOR OUR BIG 1951 CATALOG**



**SCR-27N**  
**COMMAND** and  
**ARC-5 EQUIPMENT**

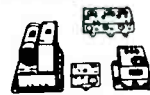

**RECEIVERS** USED NEW  
BC-453—190 to 550 KC .....\$12.95  
BC-454—3 to 6 MC ..... 6.95  
MC ..... 6.95  
BC-455—6 to 9 MC ..... 6.95  
R-23—ARC 5—190-550 KC ..... \$21.95

**TRANSMITTERS**  
BC-457—4 to 5.3 MC ..... 5.95  
BC-458—5.3 to 7 MC ..... 5.95 8.95  
BC-696—3 to 4 MC ..... 14.95 24.95  
T-19—ARC 5—3 to 4 MC ..... 24.95  
BC-459—7 to 9.1 MC ..... 12.95 24.95  
T-22—ARC 5—7 to 9.1 MC ..... 12.95 24.95

**ADDITIONAL EQUIPMENT**  
BC-456 Modulator ..... 2.25 3.25  
BC-450 Control Box (3 Receiver) ..... .98 1.95  
BC-451 Control Box (Transmitter) ..... .89 1.49  
BC-412 Relay Unit (ANT) ..... 1.95 2.95  
Plugs: PL-147, 148, 151, 152, 153, 154, 155—EACH ..... .75  
Flexible Shafting with gear to fit Receivers ..... 1.69  
3 Receiver Rack ..... 2.25  
2 Transmitter Rack ..... 1.69

**BEACON RECEIVER BC-1206-C**

Manufactured by Satchell-Carlson

Frequency Range—195 KC to 420 KC. IF Frequency—135 KC Receiver Sensitivity—3 Microvolts for 10 Milliwatts output. Output Impedance—300 Ohms and 4000 Ohms to be selected internal y. Power Output—230 Milliwatts. Volume Control—RF Gain Control, Power Supply—24-28 Volts Aeroplase Battery. Current—.75 Amperes.  
**BRAND NEW—ONLY**

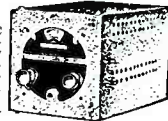

**\$795**



**HEADSETS**  
HS-23 high impedance, BRAND NEW with ear pads. **\$3.25**  
HS-33 low impedance, BRAND NEW with ear pads, cord and PJ54 plug **3.50**

**MINIMUM ORDER \$2.00**

Immediate Delivery—Send 25% deposit on C.O.D. orders. All shipments F.O.B., N.Y.C. (N.Y.C. residents add sales tax to your remittance.)

**PLATT ELECTRONICS CORP.**  
Dept. S, 489 Broome St., N. Y. 13, N.Y.  
Phones: **WO 4-0827** and **WO 4-0828**



TAB THAT'S A BUY

TUBES

TESTED—GUARANTEED

Prices Subject to Change

\*Critical Type—Write for Price

Table of vacuum tubes with columns for tube type, quantity, and price. Includes various types like 6AG7, 6AR5, 6AV6, etc.

Use Your Priority for SPEEDY DELIVERY Extend Your DO and Contract Number

Table of vacuum tubes with columns for tube type, quantity, and price. Includes various types like 6AS6, 6AT6, 6AU6, etc.

Sell Your SURPLUS TUBES & EQUIPMENT - Send List & Prices

Table of surplus tubes and equipment with columns for item name, quantity, and price. Includes items like 6C21, 6C6B, 6CD6, etc.

C-Ray Tubes

Table of C-Ray tubes with columns for tube type, quantity, and price. Includes types like 2AP5, 3BP1, 3CP1, etc.

Vacuum Capacitors

Table of vacuum capacitors with columns for capacitor type, quantity, and price. Includes types like 100P4, 100P4A, etc.

Advertisement for Infrared Snopercopes, Circuit Breakers, Mercury Thermo Regulator, and other electronic components.

Advertisement for Blowers, Photoflash, Photoflash Condensers, and other electronic components.

Advertisement for 400 Cye/115V Inpt Xformers, Constant Voltage Regulator, and other electronic components.

Advertisement for At: MANUFACTURERS, Vacuum Precision, and other electronic components.



# INDEX TO ADVERTISERS

Accurate Paper Tube Co.	331	Dumont Electric Corporation	224
Acme Electronics	320	DuMont Laboratories, Inc., Allen B.	53, 58
Aeronautical Communications Equipment, Inc.	288	Dynamic Resistor Corporation	335
Aircraft-Marine Products Inc.	48	Eastman Kodak Company, Industrial Optical Sales Div.	195
Aircraft Radio Corporation	208	Edin Company, Inc.	291
Airdesen, Inc.	329	Edison, Inc., Thomas A.	244
Airpax Products Company	307, 313	Edo Corporation	32
Alden Products Co.	273	Eitel-McCullough, Inc.	49
Allen-Bradley Co.	44	Eisler Engineering Company, Inc.	290, 337
Allen Co., Inc., L. B.	337	Electrical Industries, Inc.	167
Allied Control Company, Inc.	160	Electrical Reactance Corp.	197
Allied Radio Corp.	192, 318	Electro Development Corp.	329
Allison Radar Corporation	296	Electro Motive Mfg. Co., Inc.	159
Allmetal Screw Products Company, Inc.	303	El-Tronics, Inc.	319, 337
Altec Lansing Corp.	198	Electronic Associates, Inc.	200
American Chronoscope Corporation	224	Electronic Computer Corp.	274
American Gas Accumulator Company	196	Electronic Tube Corporation	228
American Lava Corp.	57	Eric Resistor Corporation	69
American Phenolic Corporation	162	Fairchild Camera & Instrument Corporation	16, 267
American Television and Radio Co.	324	Fairchild Engine & Airplane Corp.	237
American Time Products, Inc.	194	Federal Telecommunication Laboratories, Inc.	29
Ampex Electric Corporation	292	Federal Telephone & Radio Corporation	271
Anchor Metal Company	334	Federated Purchaser Incorporated	229
Anderson-Shaw Laboratories	331	Ferranti Electric, Inc.	201
Andrew Corporation	331	Filtron Co., Inc., The	23
Antara Products, Division of General Dyestuff Corporation	27	Fisher-Pierce Company, Inc.	294
Arma Corporation	38	Five Star Co.	337
Art Wire & Stamping Company	296	Ford Instrument Company	290
Astron Corporation	288	Gamewell Company	220
Atlas Coil Winders, Inc.	216	General Ceramics & Steatite Corp.	193
Atlas Sound Corp.	180	General Electric Company	
Audio Devices, Inc.	147	Apparatus Dept.	6, 7, 60, 70, 211, 217, 261
Automatic Electric Sales Corp.	36	Chemical Dept.	231
Avion Instrument Corp.	316	Electronics Dept.	39, 43, 67, 191, 332
Bakelite Company, A Division of Union Carbide and Carbon Corp.	199	General Plate Div. of Metals and Controls Corporation	176
Ballantine Laboratories, Inc.	178	General Radio Company	251
Barry Corporation	78	Giannini & Co., Inc., G. M.	327
Bead Chain Manufacturing Co.	212	Glaser Lead Co., Inc.	314
Beaver Gear Works, Inc.	266	G-M Laboratories, Inc.	325
Belden Manufacturing Co.	34	Grammer Transformer Corp.	325
Bell Telephone Laboratories	233	Grant Pulley & Hardware Co.	338
Bendix Aviation Corporation		Graphite Metallizing Corp.	204
Eclipse-Pioneer Division	232	Green Instrument Co.	338
Red Bank Division	165	Grieve-Hendry Co., Inc.	379
Bentley, Harris Manufacturing Co.	247	Guardian Electric Mfg. Co.	263
Beta Electric Corporation	305	Harrison Radio Corporation	289
Bird & Co., Inc., Richard H.	323	Hart Manufacturing Co.	216
Bird Electronic Corp.	318	Hathaway Instrument Co.	297
Birther Corporation	317	Haydon Company, A. W.	309
Bishop Manufacturing Corporation	335	Haydu Brothers	66
Blwax Corporation	323	Heiland Research Corporation	317
Billy Electric Company	154	Heidor Metal Products Corp.	286
Bond Electronics Corp.	336	Heliport Corporation	187
Boonton Radio Corporation	141	Hemimway & Bartlett Mfg. Co.	188
Borg Corporation, George W.	326, 327	Hermetic Seal Products Company	61
Bowser, Inc.	311	Hewlett-Packard Company	11, 12, 13
Bracke-Sieb X-Ray Company, Inc.	311	Hickok Electrical Instrument Co.	196
Bradley Laboratories, Inc.	171	Holtzer-Cabot Division of National Pneumatic Co., Inc.	173
Breeze Corporations, Inc.	330	Hudson Wire Company	161
Bridgeport Brass Co.	283	Hytron Radio & Electronics Corp.	15
Bristol Motor Co.	315	Improved Seamless Wire Company	307
Burgess Battery Company	188	Inductograph Products, Inc.	332
Burlington Instrument Co.	212	Industrial Condenser Corp.	325
Burnell and Company	64	Institute of Radio Engineers	317
C. G. S. Laboratories, Inc.	303	Instrument Electronics Corp.	294
Caddell-Burns Mfg. Co.	332	Instrument Resistors Company	72, 73
Cambridge Thermionic Corp.	234	Insuline Corporation of America	299
Cannon Electric Development Co.	268	International Nickel Company, Inc.	164
Capitol Radio Engineering Institute	329	International Rectifier Corporation	303
Carboloy Company, Inc.	46, 47	International Resistance Co.	4, 5
Centralab, Div. Globe-Union Inc.	17, 18, 19	Irvington Varnish & Insulator Company	205
Chase Brass & Copper, Sub. of Kennecott Copper Corp.	172	JFD Manufacturing Co., Inc.	35
Chicago Transformer, Div. of Essex Wire Corp.	182	Jeffers Electronics, Inc.	209
Ciba Company, Inc.	63	Jelliff Manufacturing Corporation, C. O.	319
Cinch Manufacturing Corp.	133	Jensen Manufacturing Company	33
Clarostat Mfg. Co., Inc.	22	Johnson Co., E. F.	252
Cleveland Container Company	223	Jones Div. Howard B. Clinch Mfg. Corp.	292
Clippard Instrument Laboratory, Inc.	238	Joy Manufacturing Company	300
Cohn Corporation, Sigmund	154	Juel Corporation	326
Cohan-Epner Co., Inc.	335	Kable Engineering Co.	225
Coll Winding Engineering Co.	327	Karp Metal Products Co., Inc.	45
Communications Accessories Company	302	Kartron	337
Conn, Ltd., C. G.	328	Kay Electric Company	277
Consolidated Engineering Corporation	218	Keller Products, Inc.	320
Continental Screw Company	220	Kellogg Switchboard & Supply Co.	184
Cornell-Dubiller Electric Corp.	265	Kenyon Transformer Company, Inc.	281
Corning Glass Works	169	Keppo Laboratories, Inc.	56
Cornish Wire Company, Inc.	264	Kester Solder Company	137
Corry-Jamestown Mfg. Corp.	202	Kinney Manufacturing Co.	25
Coto-Coll Co., Inc.	305	Knights Co., James	216
Craft Manufacturing Co.	306	Kollsman Instrument Corp.	213
Crosby Laboratories, Inc.	334	Krohn-Hite Instrument Co.	292
Cross Co., H.	337	Kupfria Manufacturing Co.	309
Daniels, Inc., C. R.	288	Lambda Electronics Corporation	327
Dano Electric Company	296	Lavole Laboratories, Inc.	149
Daven Co.	Third Cover	Lenz Electric Manufacturing Co.	54
De Jur Amseco Corporation	279		
Dial Light Company of America	192		
Distillation Products Industries	163		
Dollar Company, Robert, The Communication Equipment Division	309		
Donnelly Mfg. A., Div. of John Donnelly & Sons	270		
Dow Corning Corporation	337		
Driver-Harris Company	245		

## THE NEW "PRECISION" CR-30 CATHODE RAY TUBE TESTER

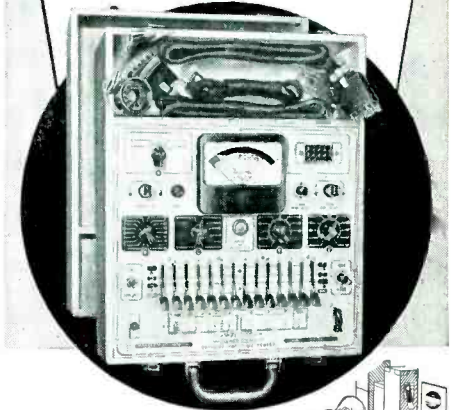

**TESTS ALL TV PICTURE TUBES**  
(Magnetic and Electrostatic)  
**'SCOPE TUBES AND INDUSTRIAL CR TYPES**



A complete and self-contained Electronic Instrument. Incorporates a TRUE BEAM CURRENT Test Circuit. Checks overall electron-gun performance for proportionate picture brightness. Additional tests for accelerating anodes and deflection plate elements.

The Precision CR-30 should not be confused with mere adapters connecting to ordinary receiving tube testers which were never designed to meet the very specialized needs of CR tube checking. Similarly, it is not to be confused with neon-lamp units or similar devices of limited technical merit and which do not check all CR tubes or all tube elements.

### GENERAL AND TECHNICAL SPECIFICATIONS

- ★ Tests All Modern Cathode Ray Tubes. Tests All CR Tube Elements! Not just a limited few.
- ★ Free-Point 14 Lever Element Selection System, independent of multiple base pin and floating element terminations, for Short, Leakage and Quality Tests.
- ★ True Beam Current Test Circuit checks all CR Tubes with Electron-gun in operation. It is the Electron Beam (and NOT total cathode emission) which traces the pattern on the face of the CR tube. The significance of the above rests in the fact that Beam Current (and picture brightness) is primarily associated with the condition of the center of the cathode surface and not the overall cathode area.
- ★ Voltage Regulated, Bridge Type VTVM affords super-sensitive tube quality indications and positive check of low current anodes and deflection plates.
- ★ Micro-Line Voltage Adjustment Meter-monitored at filament supply.
- ★ Accuracy of test circuits closely maintained by use of factory adjusted internal calibrating controls; plastic insulated, telephone type cabled wiring; highest quality, conservatively rated components.
- ★ Built In, High Speed, Roller Tube Chart.
- ★ Test Circuits Transformer Isolated from Power Line.
- ★ 4 1/2" Full Vision Meter with scale-plate especially designed for CR tube testing requirements.

★ ★ ★  
SERIES CR-30—In hardwood, tapered portable case. 17 1/4" x 13 3/4" x 6 3/4". Complete with standard 12 pin tube cable and universal CR Tube Test Cable.

Shipping Weight: 22 lbs. Net Price: \$99.75

See the new CR-30 on display at leading electronic equipment distributors. Place your orders now to assure earliest possible delivery.

**Precision Apparatus Co., Inc.**  
92-27 HORACE NARDING BLVD.  
ELMURST 10, N. Y.

Export: 458 B'way, N.Y.C., U.S.A. Cables: MORHANEX  
In Canada: Atlas Radio Corp. Ltd., Toronto, Ontario



SOLVE YOUR

# RADAR-SONAR

CALL PAUL J. PLISHNER

SUPPLY PROBLEMS

**3 CM. AIRBORNE RADAR SET** designed for sector scan surface search, mapping and navigation, weather forecasting intercepting of enemy aircraft. Entirely enclosed in a streamlined housing for optional mounting on aircraft bomb rack or on nose of large bombers. Complete sets with indicator equipment, and power unit ready for installation. Large quantity available.

APS-2

**3000 Mc BENCH TEST EQUIPMENT**

Magnetron Coupling For Type 720 Mag. to 1 1/2 x 3" Waveguide \$35.00  
 10 CM Wavemeter 3500-4500 Mc WE type B43549 Transmission type, Type N Fittings Veeeder Root Micrometer dial, Gold Plated W/Calib. Chart, P/O Freq. Meter X66404A, New \$99.50

APS-4

APS-6

APS-6A

APS-10

APQ-13

APS-15

APS-31

CPN-8

CEXH

FD MARK-4

MARK-10

SA

SC

SD

ASI44/AP-10 CM Pick up Dipole with "N" Cables \$4.50  
**LIGHTHOUSE ASSEMBLY** Part of R39 APG 5 & APG 15. Receiver and Trans Cavities w/assoc. Tr Cavity and Type N CPLG. To Revr. Uses 2C40, 2C43, 1B27. Tunable APX 2400-2700 MCS. Silver Plated Beacon Lighthouse cavity 10 cm with miniature 23 volt DC FM motor. Mfg. Bernard Rice \$47.50 ea.  
 Magnetron to Waveguide Coupler with 721A Duplexer Cavity, gold plated \$45.00

**8500 Mc to 9600 Mc BENCH TEST PLUMBING 1" x 1/2" Waveguide**

Variable Stub Tuner, DB536. 180 degree phase shifting capacity \$70.00  
 Uni-Directional Coupler, DB390 23 DB type "N" output, \$18.50  
 Pick Up Horn, Type "N" output \$4.50  
 Wavemeter, 8500 to 9400 mcs. with calibration. Micrometer adjust head. Reaction type \$85.00  
 90 Degrees Elbows, E or H plane, 2 1/2" radius \$12.50  
 90 Degree Twist, 6" long \$8.00  
 Bulkhead Feed-Thru Assembly \$15.00  
 Pressure Gauge Section 15 lb. gauge and press nipple \$10.00  
 Pressure Gauge, 15 lb. \$2.50  
 Dual Oscillator-Beacon Mount, P/O APS10 Radar for mounting two 723A B klystron with crystal mts. matching slugs, shields \$42.50  
 Dual Oscillator, Mount. (Beacon to back) with crystal mount, tunable termination attenuating slugs \$18.50  
 Directional Coupler, UG-40/17 Take off 20 DB \$17.50  
 Type "N" calibrated \$17.50  
 Rotary Joint Choke to Choke \$10.00  
 2K25/723 AB Receiver local oscillator Klystron Mount, complete with crystal mount, matching coupling and choke coupling to TR \$22.50  
 TR-ATR Duplexer section for above \$8.50  
 723AB Mixer-Beacon dual Osc. Mtr. holder \$12.00  
 TR-ATR Sect APS 15 for 1B24 w/724 ATR cavity w/1B24 & 724 Tubes. Complete \$21.00  
 Stabilizer Cavity with Bellows \$21.50  
 3 cm. 180° bend, with pressurizing nipple, ea. \$6.00  
 3 cm. 90° bend, 1 1/2" long 90° twist with pressurizing nipple ea. \$6.00  
 3 cm. "S" curve 18" long ea. \$5.50  
 3 cm. "S" curve, 6" long ea. \$3.50  
 3 cm. right angle bends, plane 18" long cover to cover ea. \$6.50  
 3 cm. Cutler feed dipole, 11" from parabola mount to feed back ea. \$8.50  
 Circular Choke Flanges, solid brass \$5.50  
 Sec. Flange, Flat Brass ea. \$5.50  
 APS-10 TR/ATR Duplexer section with additional iris flange \$10.00

721A TR Box complete with tube and tuning plungers \$12.50  
 McNally Klystron Cavity for 707B or 2K25. Three types available \$4.00  
 F 29/SPR-2 Filters, Type "N" input and output \$12.50  
**WAVEGUIDE TO 3/8" RIGID COAX DOORKNOB ADAPTER, CHOKB PLANGE, SILVER PLATED BROAD BAND \$32.50**  
**WAVEGUIDE DIRECTIONAL COUPLER, 27 db, Navy type CABV 47AAN, with 4 in. slotted section \$32.50**  
**SQ. FLANGE to rd choke adapter, 18 in. long O.A. 1 1/2 in. x 2 in. guide, type "N" output and sampling probe \$27.50**  
**AN/APRS4 10 cm antenna equipment consisting of two 10 cm waveguide sections, each polarized, 45 degrees \$75.00 per set.**  
**POWER SPLITTER: 726 Klystron input dual "N" output \$5.00**

"X" Band Pre-amplifier, consisting of 2-723 A/B local oscillator-beacon feeding waveguide and TR/ATR Duplex sect. incl. 60 pic. IF amp. \$47.50  
 45 Deg. Twist 1/2" long \$10.00  
 1/2" Section 45 deg. twist, 90 deg bend \$6.00  
 15 Deg Bend 10" choke to cover Silver Plated \$14.50  
 5 Ft. Sections choke to cover Silver Plated \$14.50  
 18" Flexible Section \$17.50  
 Bulkhead Feed Thru \$15.00  
 TR Cavity for 724 A TR Tube \$3.50  
 724 TR Tube (41 TR 1) \$2.50  
 SWR Meas. Section & L with 2 type "N" output probes MTD full wave apart. Bell size guide, Silver plated \$10.00  
 Rotary joint with slotted section and type "N" output pickup \$17.50  
 Waveguide Section 12" long choke to cover 45 deg. twist & 2 1/2" radius, 90 deg. bend. \$4.50  
 Twist 90 deg. 3" choke to cover w/press nipple \$10.00  
 Waveguide Sections 2 1/2 ft. long silver plated with choke flange \$5.75  
 Rotary Joint choke to choke with deck mounting \$17.50  
 3 cm mitered elbow "E" plane unplated \$12.00

**1 1/4" x 3/8" WAVEGUIDE**

Tunable Termination, Precision adjust \$65.00  
 Low Power Termination, \$25.00  
 Magic Tee \$45.00  
 90 Degree Elbows, E or H plane \$12.50  
 Waveguide Lengths, Cut to size and supplied with 1 choke, 1 cover, per length \$2.00 per ft.  
 BI Dir-Coupler WG output calibrated -25 db nominal, \$17.50  
 Flex sections, 12" Rubber Coated \$14.50  
 Mitered Elbow H Plane UG51-UG52 \$12.00  
 6" St. sect. choke to choke \$3.50  
 APQ 13 Constant Z Rotat Jnt \$22.50  
 CG 98B/APQ 13 12" Flex. Sect. 1 1/2" x 3/8" OD \$10.00  
 Wave Gd Run 1 1/2" x 3/8" Gd. consists of 4 ft. sect. w/RT angle bend on one end, 2" 45 deg bend on other end, \$80.00  
 X Band Wave Gd. 1 1/2" x 3/8" O.D. 1/16" wall aluminum per ft. 75c  
 Slug Tuner Attenuator W.E. guide, Gold Plated \$6.50

Link Radio Equip. 250W Fixed Station  
 Type 1908 Xmtr (152-174MC)  
 Type 1938 Remote Control Type 50-FMTR-7C (1905 Receiver, 2240 Xmtr w/Dyn Power Sply. 50 Watt Out.) Phone or Write

**SCR 545 RADAR TRAILER "L" BAND SEARCH—"S" BAND TRACK**

**MAGNETRONS**

- QK 915
- QK 62
- QK 59
- QK 61
- QK 60
- 2121
- 2122
- 2126
- 2127
- 2132
- 2137
- 2138
- 2139
- 2140
- 2149
- 2134
- 2161
- 2162
- 728
- 3131
- 5130
- 7144Y
- 718DY
- 720BY
- 720CY
- 725-A
- 730-A
- 706
- 707
- 700

**KLYSTRONS**

- 723A
- 707B
- 417A
- 2K41

**TEST SET**

- TS 12
- TS 13
- TS 33
- TS 35
- TS 36
- TS 35
- TS 35
- TS 45/APM3
- TS 62 3CM
- TS 108

**SCR 584 PARTS AVAILABLE**

- BC 1056A
- BC 1058A
- BC 1086B
- RA 71A
- BC 1090A
- BC 1090B
- BC 1096A
- BC 1058B
- BC 1094A
- BC 1088A

**MANY OTHER PARTS**

**SONAR SYSTEMS and COMPONENTS**

**IN STOCK**

- QBF
- QBG
- QC
- QCJ
- QCL
- QCO
- QCS
- QCU
- WEA

**6000 Mc to 8500 Mc BENCH TEST PLUMBING 1/2" x 3/4" Waveguide**

Klystron Mount, DB356 complete with shield and tunable termination \$125.00  
 Flap Attenuator, DB361 \$45.00  
 Variable Stub Tuner \$90.00  
 Wvgd. to Type "N" Adapter \$18.50  
 Wavemeter Tee, DB352 \$32.50  
 Magic Tee \$80.00  
 Directional Coupler, two hole 25DB coupling, type "N" output \$25.00  
 Precision Crystal Mount, Equipped with tuning slugs and tunable termination \$125.00  
 Tunable Termination, Precision adjust \$70.00  
 Low Power Load \$35.00

**4000 to 6000 Mcs BENCH TEST PLUMBING 2" x 1" Waveguide**

Flap Attenuator \$38.00  
 Variable Stub Tuner and Low Power Termination \$48.00  
 Wavemeter Tee \$48.00  
 Adapters: Choke to choke \$18.00  
 Cover to cover \$14.00  
 Choke to cover \$16.00  
 Waveguide to Type "N" Adapter \$45.00  
 Directional Coupler, Two hole type "N" output \$48.00  
 Klystron Mount, Equipped with tunable termination and micrometer adjust. Klystron antenna tuning \$110.00  
 Crystal Mount, Equipped with tunable termination and micrometer adjust crystal tuning \$125.00  
 Tunable Termination, Precision adjust \$90.00

**23,000 to 27,000 Mc BENCH TEST PLUMBING 1/2" to 1/4" Waveguide**

Precision Slotted Line, Adjustable probe \$200.00  
 Directional Coupler-Wavemeter Mnt. 12DB \$60.00  
 Precision Var Attenuator, mfg. Bernard Rice \$90.00  
 Low Power Load \$20.00  
 Shunt Tee \$35.00  
 Waveguide Lengths, 2" to 6" long, gold plated with circular flanges and coupling nuts \$2.25 per inch  
 APS-34 Rotating Joint \$49.50  
 Right Angle Bend E or H Plane, Precision combination of couplings desired \$12.00  
 45° Bend E or H Plane, Choke to cover \$12.00  
 Mitered Elbow, cover to cover TR-ATR-Section, Choke to cover Flexible Section 1" choke to choke "S" Curve Choke to cover \$4.50 Adapter, round to square cover Feedback to Parabola Horn with pressurized window \$27.50  
 K Band Mixer Block \$45.00  
 Waveguide 1/2 to 3/4" \$1.00 per ft.  
 90° Twist \$10.00  
 "K" Band Directional Coupler \$49.50 ea.

**3/8" RIGID COAX—3/8" I.C.**

3/8" rigid coaxial tuning stubs with vernier stub adjustment, Gold Plated \$17.50  
**3/8" RIGID COAX ROTARY JOINT**, Pressurized, Sperry #81061 \$24.50  
 Gold Plated \$24.50  
 Dipole assembly, Part of SCR-584 \$25.00 ea.  
 Rotary joint, Part of SCR-584 \$35.00 ea.  
**RIGHT ANGLE BEND**, with flexible coax output pickup loop \$8.00  
**SHORT RIGHT ANGLE BEND**, with pressurizing nipple \$3.00  
**RIGID COAX to flex coax connector** \$3.50  
**STUB-SUPPORTED RIGID COAX**, gold plated 5' lengths, per length \$5.00  
 RT. ANGLES for above \$2.50  
**RT. ANGLE BEND 15" L. OA** \$3.50  
**FLEXIBLE SECTION, 15" L. Male to female** \$4.25  
**MAGNETRON COUPLINGS to 3/8" rigid coax**, with TR pickup loop, gold plated \$7.00  
**FLEX COAX SECT.** Approx. 30 ft. \$16.50  
**CG 54/U-4 foot flexible section 3/8" IC pressurized** \$15.00  
**3/8" RIGID COAX**, Bead Supported \$1.20  
**SHORT RIGHT ANGLE BEND** \$2.50

**WAVEGUIDE**

1/2" x 3/4" ID \$1.00 per foot  
 1/2" x 1/2" OD \$1.50 per foot  
 3/8" x 1 1/4" OD \$1.65 per foot  
 3/8" x 1 1/4" OD Aluminum \$1.75 per foot  
 1 1/2" x 3" OD \$3.00 per foot  
 2 1/2" x 3" OD \$3.50 per foot  
 3/8" Rigid Coax Flexible \$4.00 per foot  
 3/8" Rigid Coax 3/4" IC \$1.20 per foot  
 (Available in 10 ft. to 15 ft. lengths or smaller.)

**R. F. EQUIPMENT**

SM Radar—Heavy, high power, one mega watt battleship radar. All major components, I.E. Antenna & Pedastel, Xmtr. Revr. Indicator console, Mfg. General Electric.  
 SL Radar—Complete 10 cm Surface search radar E/W P.P.I., 250 KW peak, 115V 60 Cy. AC input voltage, Mfg. Western Electric.  
 3 cm Radar package. (Copy "Must of the Month" Data!)  
 10 cm Signal Generator. Uses Sperry 417A Klystron, 115V 60 Cy. AC Regulated Power Supply. Complete w/Tubes \$250.00  
 Varied Assortment of Radar C.R. Tube Indicators from 3" A scores to 12" P.P.I. Consoles. Write!  
 RF-23/AP 10 cm Dummy Load and High Power Attenuator in 3/8" coax \$135.00  
 RG-28/U Pulse Cable 15' long w/Two UG-36/U Conn. \$18.00 ea.  
 AN/TPS-2, complete and portable, 200 MC Supplied w/Gas Generator.  
 RT-39/APG-5 10 cm light house RF head c/o Xmtr.-Revr-TR cavity, compl. revr & 30 MC IF strip using 6AK5, (2C40, 2C43, 1B27 lineup) w/Tubes.  
 Parabolic Antenna, 360° Azimuth Scan, APX 10° Elev. Tilt, Compl. w/24V. DC Drive Motor. Azimuth & Elev. Selsyns, Supplied with 10 cm Dipole. New \$85.00  
 Homogenizing Magnetostriiction Osc. Head. 300KC Unit for Homog. Liquids. Stainless Steel \$285.00

**30MC IF STRIP**

P/C APS 15. Radar using 6ACT's 2-3 Mc BW 20DB gain, new & complete I.F. Amplifier Video Sect. Less Tubes \$17.50

All merch. guar. Mail orders promptly filled. All prices, F.O.B. N.Y.C. Send M.O. or Chk. Only shipping chgs. sent C.O.D. Rated concerns send P.O.

MIN. ORDER \$3.00

## COMMUNICATIONS EQUIPMENT CO.

MIN. ORDER \$3.00

131 Liberty St., New York, N. Y. Dept. E-3

P. J. PLISHNER

Phone: Main 4-8373

Lewis & Kaufman, Inc.	294
Lewis Engineering Co.	212
Lewis Spring & Manufacturing Co.	276
Liberty Mirror Division, Libby-Owens-Ford Glass Co.	152, 153
Linde Air Products Co., Unit of Carbide & Carbon Corp.	308
Liston-Folb Instrument Co., Inc.	332
Littelfuse, Inc.	254
Litton Industries	181
Lord Manufacturing Company	210
Lust, Henry B.	337

Machlett Laboratories, Inc.	269
Macmillan Co., The	152
Magnecord, Inc.	171, 215
Magnetics, Inc.	294
Mallory and Company Inc., F. R.	80, 135
Manson Laboratories	337
Marconi Instruments, Ltd.	280
Marion Electrical Instrument Co.	2
Markem Machine Company	332
Martin Company, Glenn L.	331
MB Manufacturing Company, Inc.	10
McGraw-Hill Book Co.	321
Measurements Corporation	330
Mercoid Corporation, The	322
Metal-Cal Division, C&H Supply Co.	51
Metal Textile Corporation	200
Metaplast Process, Inc.	170
Meyercood Co.	200
Mico Instrument Co.	328
Millen Mfg. Co., Inc., James	320
Milo Radio & Electronics Corp.	295
Miniature Precision Bearing Inc.	337
Minneapolis-Honeywell Regulator Co. Industrial Division	37
Minnesota Mining & Mfg. Co.	214
Mitchell-Rand Insulation Co., Inc.	253
Monson Sales Corporation	333
Mosinee Paper Mills Company	186
Muirhead & Co., Ltd.	3
Multi-core Solders, Ltd.	9
Multi-Metal Co.	322, 323
Murex Ltd.	224
Myalex Corporation of America	52

National Company, Inc.	300
National Moldite Company	284
National Varnished Products Corporation, The	235
Neo-Sil Corporation	189
New York Transformer Co., Inc.	310
Ney Company, J. M.	300
North American Aviation, Inc.	184
North Electric Mfg. Co.	71
Northern Radio Co., Inc.	321
Northern-Zaleski, Ltd.	183
Nothelfer Winding Laboratories	338

Ohmite Manufacturing Co.	48A, 181B
Olympic Metal Products Co., Inc.	226
Onan & Sons, Inc., D. W.	321
Optical Film Engineering Co.	323
Oregon Electronics Mfg. Co.	180
Oster Manufacturing Co., John	379
Owens-Corning Fiberglas Corp.	239

Paine, Webber, Jackson & Curtis	325
Panoramic Radio Products, Inc.	285
Paper Machinery & Research, Inc.	321
Paramount Paper Tube Corp.	292
Paris International Trade Fair	180
Park Metalware Co., Inc.	335
Partridge Transformers, Ltd.	333
Phalo Plastics Corp.	313
Philam Laboratories	258
Pix Manufacturing Co., Inc.	311
Polarad Electronics Corp.	21
Polytechnic Research & Development Company, Inc.	257
Potter Instrument Co., Inc.	326
Precision Apparatus Co., Inc.	377
Precision Paper Tube Co.	208
Premax Products, Div. Chisholm-Ryder Co., Inc.	321
Presto Recording Corporation	260
Progressive Manufacturing Co.	248
Pyramid Electric Co.	75, 76
Pyroferic Co.	256

Radio Corp. of America	55, 246, 255
Back Cover	
Radio Materials Corporation	143
Radio Receptor Company, Inc.	243
Rahm Instruments, Inc.	204
Railway Express Agency, Air Express Division	249
Rauiland Corporation	28
Raytheon Manufacturing Co.	145, 312
R-B-M Division, Essex Wire Corp.	158
Rek-O-Kut Co., Inc.	333
Remler Company, Ltd.	328
Resistance Products Co.	311
Revere Copper & Brass Inc.	20
Richardson Company	14
Robinson Aviation, Inc.	262
Rome Cable Corporation	293
Russell Electric Company	219

Sanborn Company	242
Sangamo Electric Co.	168
Scientific Electric Div. of "S" Corrugated Quenched Gap Co.	307
Seintilla Magneto Division of Bendix Aviation Corp.	179
Secor Metal Corporation	336
Servo Corporation of America	305, 325
Servomechanisms, Inc.	74
Servo-Tek Products Co.	282

AND NOW A *frequency shift keyer*

THAT MEETS ALL CURRENT MILITARY AND COMMERCIAL SPECIFICATIONS.

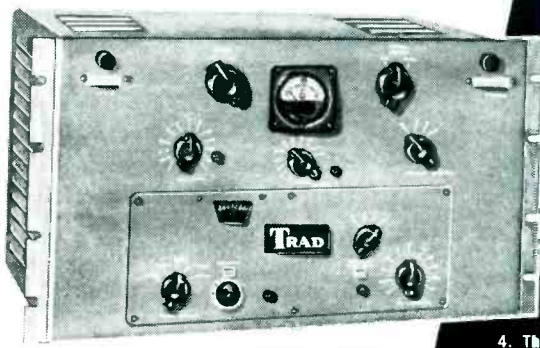

MODEL FSK-45

LITERATURE ON REQUEST  
WRITE DEPT. E3  
INDUSTRIAL DIVISION



TELEVISION CORP.

1001 FIRST AVE., ASBURY PARK, N. J.

SPECIFICATIONS

MECHANICAL:

1. Equipped for standard 19" relay rack mounting.
2. Dimensions Overall: 19" wide, 10 1/2" high, 15-1/16" deep.
3. Complete with tubes, instruction manual, less power supply.
4. Power supply available for 115 or 230 volts 50/60 cps operation.

ELECTRICAL:

1. Keyer is of the reactance tube type continuously variable over a frequency range of 0 to plus or minus 1000 cycles per second by front panel adjustment.
2. Circuitry includes phase modulation to sweep at the rate of 200 cps. Input circuit can receive polar or neutral keying and operates directly from teletypewriter.
3. Circuits are provided for photo-transmission by means of a frequency shift circuit of the reactance tube type.
4. The keyer requires an injection voltage in the range 2.2 to 4.2 megacycles to produce an output in the range 2 to 4 megacycles.
5. The equipment is capable of being keyed up to 240 det cps.
6. A wave shaping circuit provides 30 db attenuation to frequencies above the 3rd harmonic to the 240 det cycle keyer speed.
7. Stability: No more than 40 cycles instability is contributed by the keyer which is capable of maintaining the total frequency shift within 5%.
8. Controls are provided for all functions of the keyer on the front panel.

10 CUBIC FOOT PORTABLE ELECTRIC OVEN

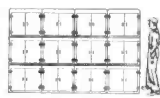

30" Wide  
25" Deep  
24" High

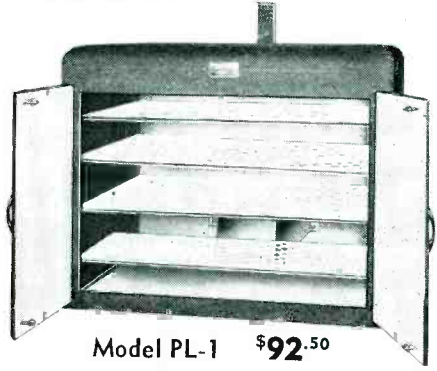

Model PL-1 \$92.50

REMOVABLE SHELVES FOR PREHEATING—DRYING—BAKING

- An individual oven for each operator
- Eliminates handling and hauling
- Can be operated in groups or banks
- Costs less than 5¢ per hour to operate
- Plugs into any 110V outlet
- Holds 8—2" x 12" x 23" drying pans (extra)

OTHER MODELS \$79.50 AND UP  
WRITE—WIRE—ORDER TODAY

GRIEVE-HENDRY CO., Inc.  
1650 W. Hadden Street  
Chicago 22, Illinois



Fractional H.P. Electric Motors!

Precision Built for DEPENDABILITY

Complete facilities for engineering, tooling and assembly of electric motors up to 6" maximum O.D. of the following types:  
Direct current—6 volts to 220 volts  
Universal motors—6 volts to 220 volts  
Induction motors—conventional voltages  
Shaded pole motors—conventional voltages  
400 cycle motors of the smaller sizes  
Also precision electro mechanical assemblies  
Experience and precision workmanship assure you of motors of dependable performance to fit your requirements—from 1/1000 H.P. up to 1/4 H.P.

QUARTER CENTURY OF EXPERIENCE IN BUILDING Fractional H. P. Motors

Here is a seasoned, dependable source with a reputation for quality and a background of electrical engineering research and design.

JOHN OSTER MFG. CO.  
RACINE, WISCONSIN



# FOR SERVICE IN COILS

No matter what your coil needs may be, you'll find in U.S.E. a dependable source of supply. For further details write for catalog today.

Cathode Trap Coils • I.F. Transformers • Width Control Coils  
 Heater Choke Coils • Video Peaking Coils • R.F. Coils  
 Horizontal Linearity Control Coils • Horizontal Oscillator Coils  
 Oscillator and Solenoid Coils • Sound Discrimination Transformers  
 Sound I.F. Transformers • Picture I.F. Transformers.

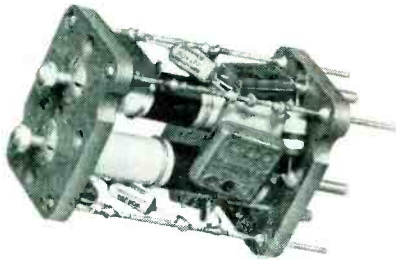

# U.S. Electronics

CORPORATION

Lyndhurst, New Jersey

Shakeproof, Inc.	241
Shallcross Manufacturing Co.	65
Shure Brothers, Inc.	222
Sigma Instruments, Inc.	79
Simpson Electric Company	82
Societe Industrielle ALFA	337
Sorensen and Company, Inc.	50
Southwestern Industrial Electronics Company	254
Specialty Battery Company	288
Spellman Television Co., Inc.	331
Spencer-Kennedy Laboratories, Inc.	313
Sperry Gyroscope Company	203
Sperli Paraday, Inc.	337
Spincraft, Inc.	192
Sprague Electric Company	139
Square Root Manufacturing Corp.	299
Stackpole Carbon Co.	24
Standard Piezo Company	319
Standard Pressed Steel Co.	329
Standard Products, Inc.	254
Standard Telephones and Cables, Ltd.	206
Standard Transformer Corp.	184
Statham Laboratories	324
Staver Company, Incorporated	254
Steward Manufacturing Co., D. M.	323
Stoddart Aircraft Radio Co.	298
Streeter-Amet Company	208
Stupakoff Ceramic & Manufacturing Company	227
Sun Radio & Electronics Co., Inc.	315
Superior Electric Co., The	30
Superior Tube Company	221
Sylvania Electric Products, Inc.	77, 151
Syntrotron Co.	294
Technology Instrument Corp.	278
Tektronix, Inc.	336
Telechron, Inc.	207
Teletronics Laboratory, Inc.	337
Tel-Instrument Co., Inc.	220
Tenney Engineering, Inc.	230
Tensolite Insulated Wire Co., Inc.	330
Terpening Company, L. H.	272
Thomas & Skinner Steel Products Company	190
Thor Ceramics, Inc.	315
Torocoil Company	292
Trad Television Corp.	379
Transcoil Corporation	301
Transradio, Ltd.	204
Trans World Airlines	188
Tung-Sol Lamp Works, Inc.	24A, 24B, 24C, 24D
Turner Company	8
Union Carbide and Carbon Corp., Bakelite Company	199
Union Carbide and Carbon Corp., The Linde Air Products Co. Unit	308
Union Electric Products Co.	327
United Electronics	185
United States Electronics Corporation	330
United States Testing Co., Inc.	322
United Transformer Co.	2nd Cover
Universal Mfg. Co., Inc.	266
University Loudspeakers Inc.	299
Variflex Corporation	68
Varian Associates	286, 287
Veeder-Root, Inc.	42
Victoreen Instrument Company	240
Volkert Metal Stampings, Inc., John	259
Waldes Kohinoor, Inc.	59
Ward Leonard Electric Company	166
Ward Products Corp., The	304
Washington Technological Associates, Incorporated	331
Waterman Products Co., Inc.	40, 41
Western Lithograph Co.	196
Westinghouse Electric Corp.	177
White Dental Mfg. Company, S. S.	236, 296
Whitehead Stamping Company	325
Whider Mfg. Co., Inc.	290
Winchester Electronics Inc.	334
Workshop Associates, Inc.	275
Zetka Television Tubes Inc.	175
Zophar Mills, Inc.	290
PROFESSIONAL SERVICES	339
SEARCHLIGHT SECTION (Classified Advertising)	
EMPLOYMENT	
Positions Vacant	340-347
Selling Opportunities Offered	340
Positions Wanted	340
Selling Opportunities Wanted	340
Employment Services	340
BUSINESS OPPORTUNITIES	
Offered	340
EQUIPMENT	
(Used or Surplus New)	
For Sale	348-376, 378

## WANTED

Equipment .....339, 362, 369, 372

## ADVERTISERS INDEX

Acorn Electronics Corp.	366
AC Spark Plug Div General Motors Corp.	346
Adelman, Nat.	375
Aerojet Engineering Corp.	341
Airborne Instruments Laboratory, Inc.	343
Algeradio Electronics Co.	374
Alvarado Supply Co.	371
American Electrical Sales Co.	372
Amperex Electric Corp.	347
Arrow Appliance Co.	372
Arrow Sales Co., Inc.	370
Bell Aircraft Corp.	344, 346
Bendix Aviation Corp. Pacific Division	347
Bendix Aviation Corp., Radio Div.	242
Blan	275
Boonton Radio Corp.	340
Brooks, B. D.	375
Brush Development Co.	346
C & H Sales Co.	374
Capehart-Farnsworth Corp.	371
Chase Electronic Supply Co.	368
Columbia Electronics, Ltd.	373
Communication Devices Co.	373
Communications Equipment Co.	358, 359, 378
Cornell Aeronautical Laboratory	340
Cottone & Co., A.	371
Cunningham Engineering Co.	374
Designers for Industry, Inc.	344
Eckert-Mauchly Computer Corp.	344
Electro Impulse Laboratory	364, 368
Electronic Engineering Co. of Calif.	342
Electronic Surplus Brokers	372
Electroncraft, Inc.	351
Empire Electronics	372
Engineering Research Assoc.	345, 346
EPCO	373
F. M. Electronics Co.	372
Fairchild Guided Missile Div.	342
Franklin Institute, The	343
French-Van Breens, Inc.	367
General Electric Co.	346
Goodyear Aircraft Corp.	341
Green, Gould	369
Greenwich Sales	371
Hallcrafters Co.	342
Hazeltine Electronics Corp.	344
Hughes Aircraft Co.	343
Instrument Associates	348, 349
International Business Machines Corp.	344
Interstate Appliance Co., Inc.	369
Kings County Machinery Exchange	375
Lear, Inc.	343
Leetronic Research Laboratories	353
Legri S. Co.	362
Lenkurt Electric	344
Lera Laboratories, Inc.	364
Lera Laboratories, Inc.	361
Liberty Electronics, Inc.	360
Life Electronics Sales	374
Maritime International Co.	357
Maritime Switchboard	343
Maxson Corp., The W. L.	347
Melpar, Inc.	369
Metropolitan Overseas Supply Corp.	367
Mogull Co., Inc., Alexander	363
Monmouth Radio Laboratories	340
Monson Sales Co.	347
National Union Research Div.	374
New England Electronics Co.	356
Niagara Radio Supply Corp.	370
Norman Radio Distributors, Inc.	370
Opad-Green Co.	368
Overbrook Co., The	346
Phillips Petroleum Co.	369
Photocon Sales	375
Platt Electronics Corp.	368
Powell, Harold H.	366
Powell, Ted	368
Precise Measurements Co.	373
Precision Electrical Instrument Co.	375
Radio & Electronic Surplus	355
Radio Ham Shack, Inc.	366
Red Arrow Sales	354
Reliance Merchandising Co.	340
Routh Co., William G.	372
Sagal Co., Leo	345
Sandia Corp.	350
Servo-Tek Products Co., Inc.	372
Stanley Engineering & Mfg. Co.	369
Stevens Aircraft Corp., The	343, 347
Sylvania Electric	375, 376
TAB	368
Technical Radio Parts Co.	372
Telemarine Communications Co.	372
Tehe Deutschmann Corp.	372
United Aircraft Corp. Chance Vought Aircraft Div.	344
Universal General Corp.	365
Varian Assoc.	342
Victor-Bernard Industries	339
Wells Sales, Inc.	352
West Region Electronics	339
Westinghouse Electric Corp.	345
Weston Laboratories	374
Wilgreen	368

This Index is published as a convenience to the readers. Every care is taken to make it accurate, but ELECTRONICS assumes no responsibility for errors or omissions.



# POWER AND IMPEDANCE MEASUREMENTS

# DAVEN

## OUTPUT POWER METERS *of unexcelled accuracy and reliability* have many applications

TYPE OP-182



Impedance Range: 2.5 ohms to 20,000 ohms. Remains essentially resistive over frequency range of 30 to 10,000 cps. Accuracy  $\pm 5\%$ .

Power Range: 0.1 mw. to 5 watts in steps of 0.1 mw.  
Indicating Meter: Calibrated from 0 to 50 milliwatts and from 0 to 17 db.  
—Zero level: 1mw.

Meter Multiplier: Will change reading of indicating meter by ratios of 0.1:1, 1:1, 10:1, 100:1, or decibel reading by -10, 0, +10, +20.

The DAVEN Output Power Meters are designed to measure the actual power delivered by an audio signal system to a given load. However, because of the characteristics of the circuit, they are admirably suited to other applications, namely:

1. Determination of Characteristic Impedance of an A.C. Source.
2. Effects of Load Variation on a Signal System.
3. Transmission Line Equalization Measurements.
4. Measurement of Insertion Loss in Multi-channel Mixer and other complex circuits.
5. Filter and Transformer Measurements.
6. Radio Receiver Measurements.

The equipment shown on this page is built to DAVEN'S well-known standards of precision. Please write for more detailed data. Let our engineering department help you on specific problems.

TYPE OP-962



Characteristics similar to OP-961, except that it can measure up to 100 watts.  
Impedance Range: 40 selected impedances between 2.5 and 20,000 ohms.  
Accuracy  $\pm 2\%$  over frequency range 30 to 10,000 cycles.

Power Range: 0.1 mw to 100 watts in 0.1 mw steps.  
Range may be extended below 0.1 mw by use of external amplifier.

Indicating Meter: Calibrated from .01 watt to 1 watt and from -10 to +10 db. Zero level: 1mw.

Meter Multiplier: Extends range of meter from 0.01 to 100 times scale reading.

TYPE OP-961



Impedance Range: 2.5 ohms to 20,000 ohms. Remains essentially resistive over frequency range of 30 to 10,000 cps. Accuracy  $\pm 2\%$ .

Power Range: 0.1 milliwatts to 50 watts in steps of 0.1 milliwatts.

Indicating Meter: Calibrated from 1 to 50 milliwatts and 0 to 17 decibels.  
Zero level: 1mw.

Meter Multiplier: Extends the power reading of the indicating meter from 0.1x to 1,000x scale value, or the db. reading from -10 to +30 db. in steps of 2 db.

# THE DAVEN CO.

191 CENTRAL AVENUE • NEWARK 4, NEW JERSEY

Visit Daven at the I.R.E. Show  
Booths 94B and 95



## RCA PREFERRED-TYPE RECEIVING TUBES

Miniature types are shown in italics

RECTIFIERS and DIODE DETECTORS	CONVERTERS	AMPLIFIERS, OSCILLATORS & MIXERS						OUTPUT AMPLIFIERS
		Triodes			Pentodes			
		Single	Twin	With Diodes	Sharp Cutoff	Remote Cutoff	With Diode	
1B3-GT	1R5				1U4	114	1U5	354 3V4
5U4-G 5Y3-GT	6BA7 6BE6	6C4	6J6 6SC7 6SN7-GT	6AQ6 6AV6 6BF6	6AU6 6CB6 6SJ7	6BA6 6B6	12A6	6AQ5 6AU5-GT 6BG6-G 6BG-GT 6BG-G 6VL-GT
6AL5 6W4-GT 6X4	12BA7 12BE6		12AU7 12AX7	12AV6	12AU6	12BA6		35CS 50CS
12AL5 35W4 117Z3								

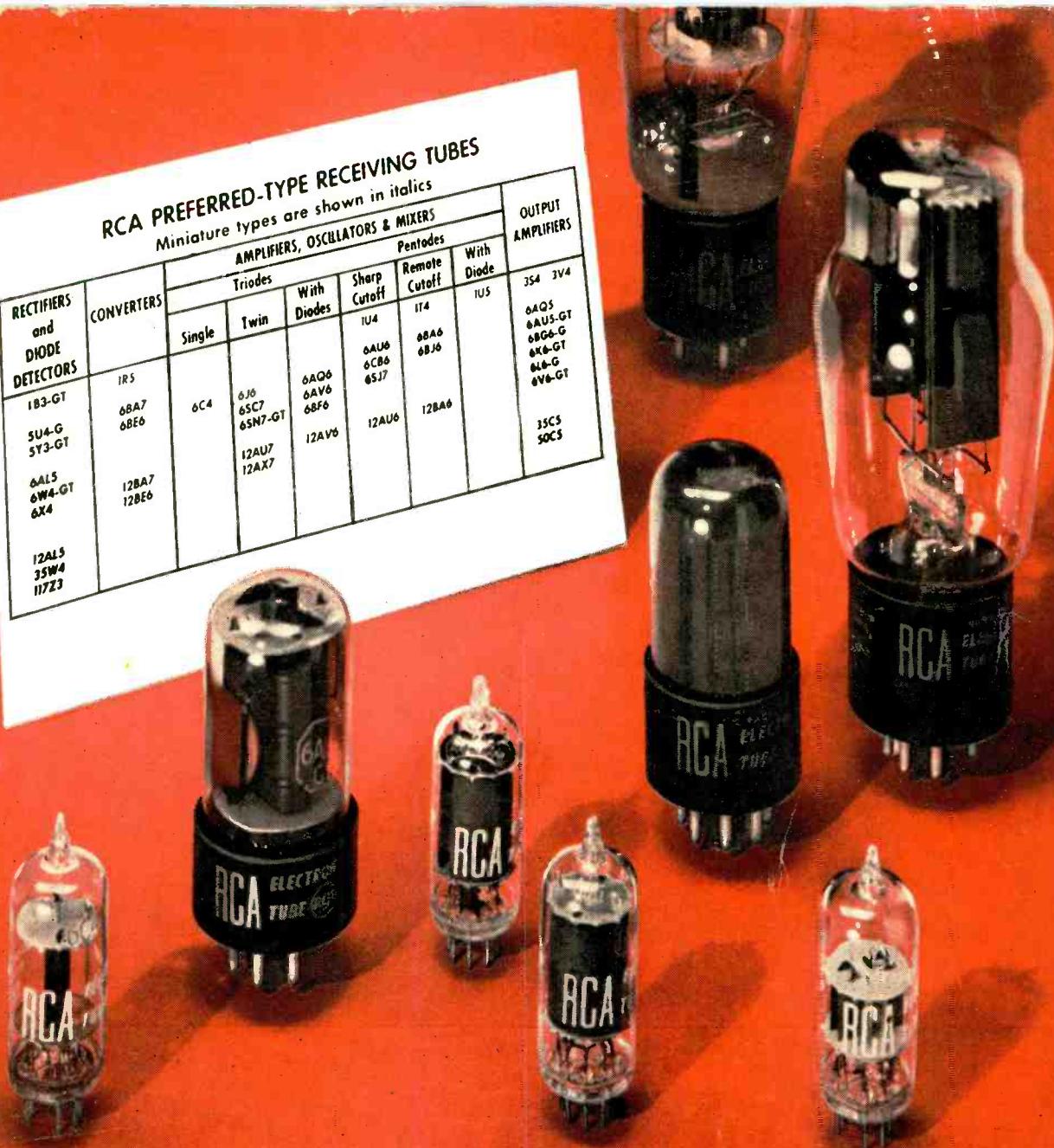

THE FOUNTAINHEAD OF MODERN TUBE DEVELOPMENT IS RCA

# ***Performance-Proved*** in active duty

For civilian and military electronic designs . . . RCA preferred-type receiving tubes offer these important advantages . . .

**FLEXIBILITY**—RCA *preferred-type* receiving tubes are chosen for the advantages they offer from engineering and equipment production viewpoints. They cover an extremely wide variety of tube applications in civilian and military equipment...and offer the engineer flexibility in circuit design.

**PERFORMANCE**—These types have demonstrated their reliability in equip-

ment of widely divergent designs. Proved in service, they are the logical types for future designs.

**ECONOMY**—This group of 44 tube types represents *more than half* of RCA's current receiving tube volume. By concentrating production on these few types having wide application, substantial savings are realized in manufacturing costs which are passed on to

customers . . . and quality and performance capability are sustained at a high level.

**STANDARDIZATION**—By concentrating on RCA preferred receiving-tube types, the equipment manufacturer also benefits by his ability to standardize on component parts . . . resulting in substantial purchasing and stocking economies.



**RADIO CORPORATION of AMERICA**  
ELECTRON TUBES

HARRISON, N.J.